

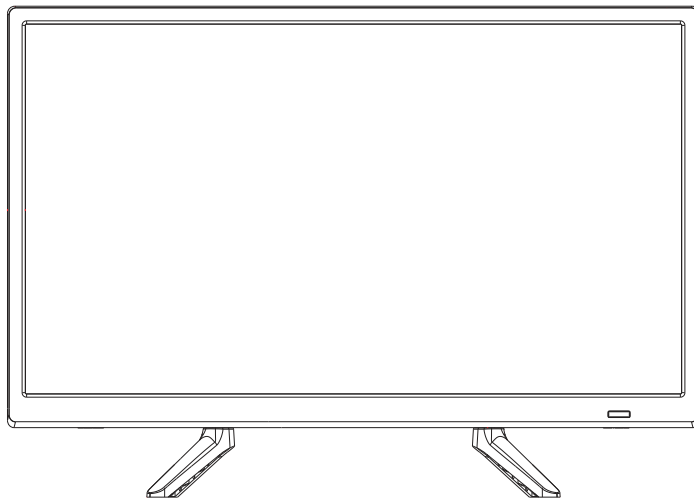

HD LED TV with DVB-T2/S2/DVB-C and H.265/HEVC Support

Model: LED-2472



User's Guide

NOTE:

Read all of the instructions before using this TV and keep the instruction manual in a safe place for future reference.

Denver.eu

CONTENTS

SPECIFICATIONS

..... 1

SAFETY INSTRUCTIONS

..... 2-4

DESCRIPTION OF CONTROL KEYS & CONNECTORS

..... 5-6

OPERATION OF REMOTE CONTROL

..... 7-8

OPERATION OF FUNCTION MENU

..... 9-17

TROUBLE SHOOTING GUIDE

..... 18

SPECIFICATIONS

Aspect Ratio	16 : 9
System	PAL/SECAM BG/DK/I, DVB-T/C+T2, DVB-S/S2(Optional)
Base impedance	75 Ω (Unbalance)
Receiving TV Band	All Channels Receiveable
AC Supply Voltage	100-240V~ 50/60Hz

Note: Part of the design and the specification may be changed without prior notice.

INFRA-RED REMOTE CONTROL

Features: Full function remote control

Effective Distance Power: 8 metres



Power Supply: DC 3V (Two batteries, size AAA, recommend use alkaline type batteries)

SAFETY INSTRUCTIONS

IMPORTANT SAFETY INSTRUCTIONS

WARNING

- TO PREVENT FIRE OR SHOCK HAZARD, DO NOT USE AN EXTENSION CORD, RECEPTACLE OR OTHER OUTLET UNLESS THE BLADES CAN BE TO PREVENT BLADE EXPOSURE.
- TO PREVENT FIRE OR SHOCK HAZARD, DO NOT EXPOSE THIS APPLIANCE TO RAIN OR MOISTURE.

 <p>This lightning flash with arrowhead symbol in an equilateral triangle alerts users to the presence of uninsulated dangerous voltage within the products enclosure that may be of sufficient magnitude to constitute a risk of electric shock.</p>	<h4>CAUTION</h4> <p>RISK OF ELECTRIC SHOCK DO NOT OPEN</p> <p>Warning: To reduce the risk of electric shock, do not remove cover(or back). No user serviceable parts inside. Refer servicing to qualified service personnel.</p>	 <p>The exclamation mark within an equilateral triangle alerts users to the presence of important operating and maintenance (servicing) instructions in the literature accompanying the appliance.</p>
--	---	--

This appliance should not be exposed to water and no object filled with liquid such as a vase should be placed on the unit.

CAUTION

- Danger of explosion if batteries are incorrectly replaced.
- Replace with only equivalent type of battery.
- Do not expose battery to direct sunlight or any other source of heat.
- Ensure proper disposal of used batteries.
- Where the MAINS plug or an appliance coupler is used as the disconnect device, the disconnect device shall remain readily operable.
- To reduce the risk of electric shock, do not perform any servicing other than what is mentioned in the operating manual.
- There are no user-serviceable parts inside the TV; do not open the TV casing.

IMPORTANT INFORMATION

If a television is not positioned in a sufficiently stable location, it can be potentially hazardous due to falling. Many injuries, particularly to children, can be avoided by taking simple precautions such as:

- Using cabinets or stands recommended by the manufacturer of the television.
- Only using furniture that can safely support the television.
- Ensuring the television is not overhanging the edge of the supporting furniture.
- Not placing the television on tall furniture (for example, cupboards or bookcases) without anchoring both the furniture and the television to a suitable support.
- Not standing the televisions on cloth or other materials placed between the television and supporting furniture.
- Educating children about the dangers of climbing on furniture to reach the television or its controls.



Safe installation

Use the belt fixing the television to facilitate restraining the television from toping forward.



SAFETY INSTRUCTIONS

1. **Read Instructions** - All the safety and operating instructions should be read before the appliance is operated.
2. **Retain Instructions** - The safety and operating instructions should be retained for future reference.
3. **Heed Warnings** - All warnings on the appliance and in the operating instructions should be adhered to.
4. **Follow Instructions** - All operating instructions should be followed.



5. **Water and Moisture** - The appliance should not be used near water.
6. **Cart and Stands** - The appliance should only be used with a cart or stand that is recommended by the manufacturer.
7. **Wall or Ceiling Mounting** - The appliance should be mounted to a wall or ceiling only as recommended by the manufacturer.
8. **Ventilation** - The appliance should be well situated so that its location or position does not interfere with its proper ventilation.
9. **Heat** - This appliance should be placed away from heat sources such as radiators, heat registers and stoves.
10. **Power Sources** - The appliance should only be connected to a power supply as described in the operating instructions or as marked on the appliance.
11. **Grounding or Polarization** - Precautions should be taken.
12. **Power Cord Protection** - Power supply cord should be routed so that it is not likely to be walked on, pinched by items placed upon it against the cord and its end.
13. **Cleaning** - The appliance should be cleaned only as recommended by the manufacturer.
14. **Power Line** - An outdoor antenna should be located away from power lines.
15. **Outdoor Antenna Grounding** - If an outside antenna is connected to the receiver, the antenna system must be grounded so as to provide against voltages and built-up static charges.
16. **Non-use Periods** - The power cord of the appliance should be unplugged from the outlet when left unused for a long period of time.
17. **Object and Liquid Entry** - Care should be taken so that objects did not fall, and liquids are not spilled into the enclosure through openings.
18. **Conditions requiring Service** - The appliance should be serviced by qualified service personnel when:
 - The power-supply cord or the plug has been damaged.
 - Objects have fallen on or liquid has been spilled into the appliance.
 - The appliance has been exposed to rain.
 - The appliance does not appear to operate normally or exhibits a marked change in performance.
19. The ventilation should not be impeded by covering the ventilation opening with items, such as newspapers, table-cloths, curtains, etc.
No naked flame sources, such as lighted candles, should be placed on the apparatus.
The apparatus shall be connected to mains socket outlet with a protective earthing connection.
The appliance coupler regard as disconnection device, the disconnect device shall remain readily operable.
20. The equipment may be used in tropical and moderate climates.

SAFETY INSTRUCTIONS



Warning

High voltages are used in the operating of this product. Do not remove the back cover of the cabinet. Refer servicing to qualified service personnel.

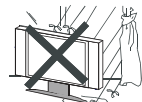

Warning

To prevent fire or electrical shock hazard, do not expose the main unit to rain or moisture.



Warning

Do not drop or push objects into television cabinet slots or openings. Never spill any kind of liquid on the television receiver.

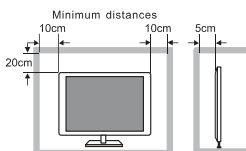

Caution

If the television is to be built into a compartment or similarly enclosed, the minimum distances must be maintained.

Heat built up can reduce the service life of your television, and can also be dangerous.



Caution

Never stand on, lean on, push suddenly the product or its stand.

You should pay special attention to children.

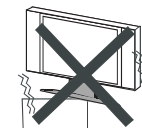

Caution

Do not place the main unit on an unstable cart stand, shelf or table.

Serious injury to an individual, and damage to the television, may result should it fall.



Caution

When the product is not used for an extended period of time, it is advisable to disconnect the AC power cord from the AC outlet.

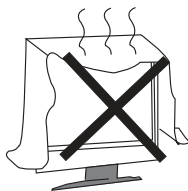

Caution

Avoid exposing the main unit to direct sunlight and other sources of heat. Do not position television receiver directly on other products which give off heat. E.g. Video cassette players, audio amplifiers. Do not block the ventilation holes in the back cover. Ventilation is essential to prevent electrical failure. Do not squash power supply cord under the main unit.



Caution



















The panel used in this product is made of glass. It can break when the product is dropped or applied with force.

Individuals should execute caution when dealing with broken glass should the panel break.



DESCRIPTION OF CONTROL KEYS & CONNECTORS







CONTROL KEYS:

BUTTON NAME	BUTTON ICON TYPE					BUTTON INSTRUCTION
	1	2	3	4	5	
SOURCE BUTTON	SOURCE			INPUT	INPUT	To display source menu.
MENU BUTTON	MENU			MENU	MENU	To select menu.
VOLUME UP BUTTON	VOL+				VOL+	To increase the sound volume level
VOLUME DOWN BUTTON	VOL-				VOL-	To decrease the sound volume level
PROGRAM UP BUTTON	CH+				CH+	To select the next higher programme number.
PROGRAM DOWN BUTTON	CH-				CH-	To select the next lower programme number.
STANDBY BUTTON	POWER			STANDBY	STANDBY	Switch ON/OFF the TV when at standby mode.

NOTE:





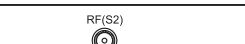











1. All these control buttons designs are common use for our TV models, and please refer to that under your real product.
2. This control keys quantity can be different according to models, and please refer to your real product in hand.

CONNECTORS:

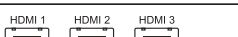
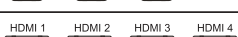
PORT NAME	PORTS ICON TYPE	PORT INSTRUCTION
AV IN	1 	AV input port
	2 	
	3 	
	4 	
COMPONENT IN	1 	YPbPr signal input port
	2 	
TERMINAL ANTENNA (75 OHM)		TV signal input port
TERMINAL ANTENNA (75 OHM)		Satellite signal input port

DESCRIPTION OF CONTROL KEYS & CONNECTORS

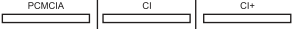
CONNECTORS:

PORT NAME	PORTS ICON TYPE	PORT INSTRUCTION
VIDEO OUT		Video output port
OPTICAL OUT		Optical output port
COAXIAL OUT		Coaxial output port
AUDIO OUT		Audio output port
LINE OUT		Audio output port
EARPHONE OUT		Earphone output port
VGA IN		RGB signal input port
VGA AUDIO IN		VGA audio input port
HDMI IN	1 	HDMI signal input port
	2 	
	3 	
	4 	
USB IN	1 	USB input port
	2 	
SCART		SCART signal input port
PCMCIA(CI/CI+) IN		PCMCIA(CI/CI+) card input port
DC IN		DC +12V input port
AUDIO IN		Audio input port

NOTE:

1. All these terminal connection icons are commonly used for our TV models, and please select designated ports.
2. This connection ports quantity can be different according to models, and please refer to your actual product.

OPERATION OF REMOTE CONTROL

The remote controller cannot be used unless it is within the receivable range. Before you use the remote control, please make sure there's no obstacle between the remote control and the receiver.

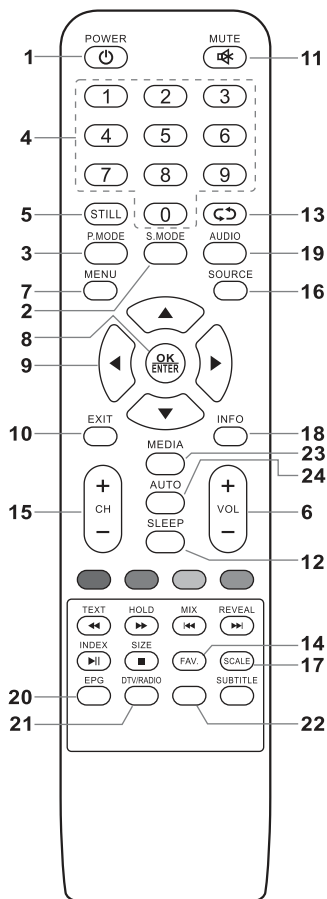

1. POWER BUTTON

Switch On/Off the TV when at standby mode.

2. S.MODE BUTTON

Sound effect selection.

3. P.MODE BUTTON

Picture effect selection.

4. NUMBER BUTTONS

Press these buttons to select the TV program you want to enter or input password.

5. STILL BUTTON

Freeze picture.

6. VOL+/VOL- BUTTON

Press two buttons to directly to turn up or turn down the sound volume level.

7. MENU BUTTON

Press the button to open the main menu, press again or use Exit to close.

8. OK/ENTER BUTTON

Press the button to confirm or enter sub menus.

9. UP, DOWN, LEFT, RIGHT ARROW BUTTONS

Press these buttons to select or adjust the desired item on the TV menu.

10. EXIT BUTTON

Press the button to exit.

11. MUTE BUTTON

Press the button to turn off the volume. Press it again to turn on the volume.

12. SLEEP BUTTON

Press the button to set up the TV auto turn off time.

13. RETURN BUTTON

Press the button to toggle between the current and the previous program you were viewing.

14. FAV. BUTTON

Display favourite of program list.

15. CH+/CH- BUTTON

Press two buttons to directly to adjust the TV program.

16. SOURCE BUTTON

Press the button to display Source menu.

17. SCALE BUTTON

Press the button to display and select available aspect modes.

18. INFO BUTTON

Display the Source, and channel etc. information.

19. AUDIO BUTTON (Optional)

Selects audio mode.

20. EPG BUTTON

Open/Close Electronic program guide.

21. DTV/RADIO BUTTON

Switch DTV program and radio program.

22. REC BUTTON (Optional)

Hotkey of PVR.

23. MEDIA BUTTON

Directly into the USB mode.

24. AUTO BUTTON

In VGA mode, picture position automatic correction.

Note:

EPG, DTV/RADIO, REC are only effective in DTV mode.

OPERATION OF REMOTE CONTROL

TELETEXT FUNCTION (Optional)

1) TEXT BUTTON

Press the TEXT button to change the viewing from TV to Teletext if TV stations in your local have teletext broadcasting.

2) REVEAL BUTTON

This is a toggle function key to display hidden characters.

3) MIX BUTTON

This is a toggle function button to display TV picture and teletext together or teletext only.

4) RED/GREEN/YELLOW/BLUE BUTTONS

These 4 Colour keys in teletext mode can quickly enter the pre-captured teletext pages.

5) ▲ / ▼ BUTTON

These keys can be used as a page up/down key in teletext mode.

6) 0, 1, 2, ..., 9 BUTTON

Using the 0, 1, 2, ..., 9 keys, the required Teletext pages are selected.

7) HOLD BUTTON

Some Teletext information is contained on more than one page, the pages automatically changing after a given reading time. Press the HOLD key to stop the page changing. Press the HOLD key again to allow the page to change.

8) SIZE BUTTON

This key is to expand character size and display half teletext page. Each press will display upper tower Normal page.

9) INDEX BUTTON

Press the INDEX key to view Index page in teletext mode.

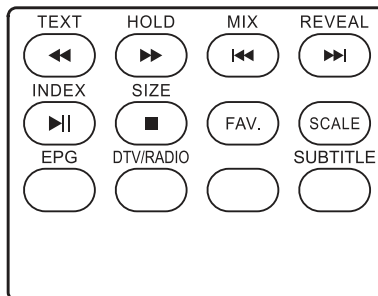

USB FUNCTION

1) ◀ / ▶ BUTTON

Skip a scene or music.

2) ◀◀ / ▶▶ BUTTON

Go back to the previous or skip to the next.

3) ▶|| BUTTON

Play / Pause.

4) ■ BUTTON

Stop playback.

5) SUBTITLE BUTTON

In the USB playback movies, open or closed subtitle function (Need streaming support)

Note:

A USB device must already be connected.

BATTERY INSTALLATION OF REMOTE CONTROL UNIT

1. Open the battery compartment cover.
2. Insert two 'AAA' (pencil size) 1.5V batteries. Make sure the polarity (+ or -) of the batteries matches the polarity marks inside the unit.
3. Close the battery compartment cover.

Note:

- Recommend use alkaline type batteries.
- The life time of the batteries may last up to one year, depending on how often the remote control is used. For the best performance, the batteries should be replaced on a yearly basis, or when remote operation becomes erratic.
- Be sure to place the batteries in the correct direction, as shown left.
- Do not mix old and new batteries, or different types.
- Old batteries may leak chemical and damage the remote control. Always remove batteries as soon as they become weak.

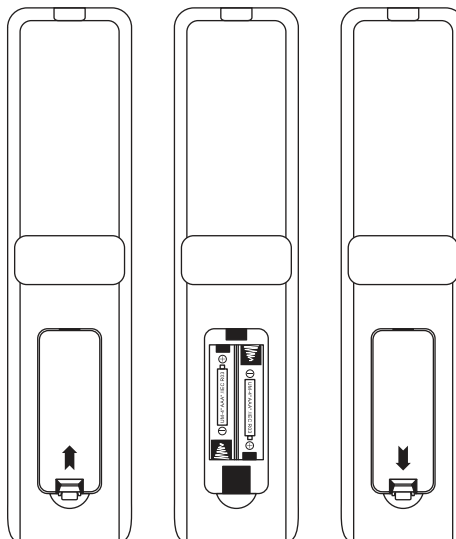

OPERATION OF FUNCTION MENU

CHANNEL menu

Press "MENU" and [◀▶] buttons to select the CHANNEL menu.
 Press [▲/▼] button to select the items
 Press OK button to enter the submenu.

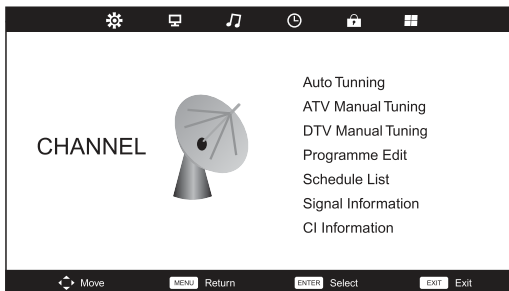

Note: CI Information is option.

Auto Tuning: Press [▶] or [OK] to start auto tuning of both ATV and DTV channels.

ATV Manual Tuning: Press [▶] or [OK] to enter "ATV Manual Tuning" submenu.

Current CH: Press [◀▶] to select the channel number you want to store.

Color System: Press [◀▶] to change the color system as Auto, SECAM, PAL.

Sound System: Press [◀▶] to change the sound system as DK, I, BG, L.

Fine-Tune: Press [◀▶] to scan current program within a frequency range accurately and store the result manually.

DTV Manual Tuning: Press [▶] or [OK] to enter "DTV Manual Tuning" submenu.

Press [◀▶] to select channel, then press [OK] to search programs.

Note: Only channels with sufficient signal strength will be tuned in: check your antenna if channels are missing after Auto Tuning.

Programme Edit: Press [▶] or [OK] to enter "Programme Edit" submenu.

This option has five functions:

1. Press Red button to delete the current channel.
2. Press Yellow button and [▲/▼] to move the current channel.
3. Press Blue button to skip the current channel.
4. Press [FAV] to set the current channel to your favorite channel, there will be a red heart at the behind of the channel selected. If the current channel is already be one of your favorite channel, press it again will set it to a normal one.

Schedule List

Display Schedule List and Recorded List.

Signal Information:

Display the signal information in DTV mode.

CI Information(Optional):

Please contact your "pay perview" provider who can supply a viewing card and cam unit with instructions for their use.

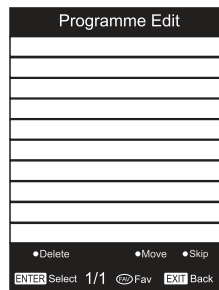
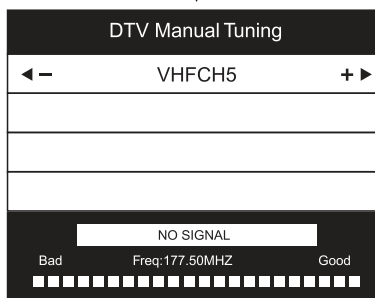
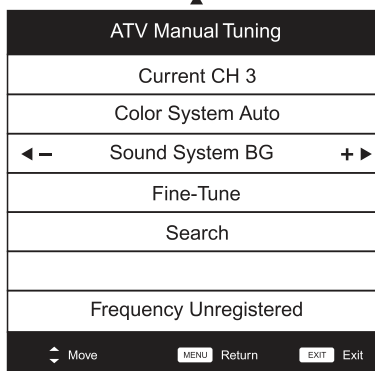

OPERATION OF FUNCTION MENU

PICTURE menu

Press [MENU] to display the main menu.
Press [◀▶] to select "PICTURE" in the main menu, then press [▼] or [OK] to enter.

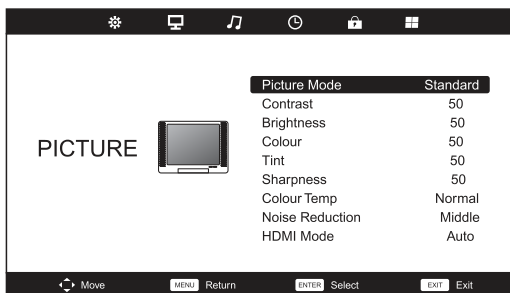

Picture Mode: Press [◀▶] or [OK] to enter "Picture Mode" submenu. Press [▲▼] to change the picture mode in sequence: Dynamic → Standard → Mild → Personal.

You can press [P.MODE] repeatedly on the remote control to change the picture mode directly.

Contrast: Press [◀▶] or [OK] to enter submenu. Press [◀▶] to set the picture's contrast intensity.

Brightness: Press [◀▶] or [OK] to enter submenu. Press [◀▶] to set the picture's brightness.

Colour: Press [◀▶] or [OK] to enter submenu. Press [◀▶] to set the picture's colour intensity.

Tint: Press [◀▶] or [OK] to enter submenu. Press [◀▶] to set the picture's tint. (Available for NTSC video signal only)

Sharpness: Press [◀▶] or [OK] to enter submenu. Press [◀▶] to set the picture's sharpness.

Colour Temp: Press [◀▶] or [OK] to enter "Colour Temp" submenu. Press [▲▼] to change the colour temperature in sequence: Cold → Normal → Warm.

Noise Reduction: Press [◀▶] or [OK] to enter "Noise Reduction" submenu. Press [▲▼] to change the noise reduction in sequence: Off → Low → Middle → High → Default.

Press the "SOURCE" button on the remote control to enter the OSD menu then press [▲▼] button to select "SCREEN" item. Press "OK" button to enter "SCREEN" mode.

SCREEN menu

(Only available when connected via SCREEN to a PC)
Automatic adjust the picture of the right size.

Press [▲▼] button to select "Auto Adjust" or "Position Reset" item.

Press [▶] or [OK] button to Adjust.

Press [▲▼] button to select "H-Offset", "V-Offset", "Size" or "Phase" of the project.

Press [◀▶] button to adjust.

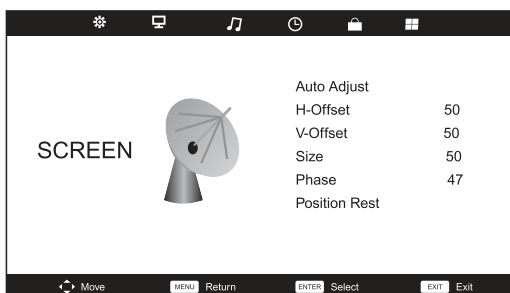

SOUND menu

Press [MENU] to display the main menu.
Press [◀▶] to select "SOUND" in the main menu, then press [▼] or [OK] to enter.

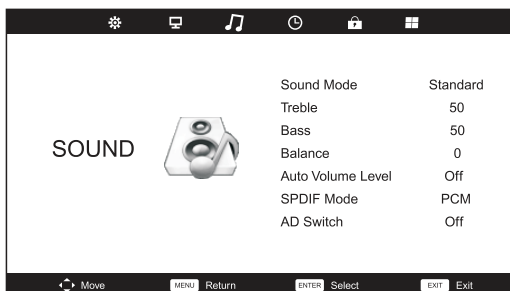

OPERATION OF FUNCTION MENU

Sound Mode: Press [◀▶] or [OK] to enter "Sound Mode" submenu. Press [▲▼] to change the sound mode in sequence: Standard → Music → Movie → Sports → Personal. You can press [S.MODE] repeatedly Treble: Press [◀▶] or [OK] to enter submenu. Press [◀▶] button to adjust.

Balance: Press [◀▶] or [OK] to enter Bass: Press [◀▶] or [OK] to enter submenu. Press [◀▶] button to adjust speaker's balance.

Auto Volume Level: Press [◀▶] or [OK] to set the automatic volume level to "On" or "Off".

SPDIF Mode: Press [◀▶] or [OK] to set the SPDIF mode to "Auto", "Off" or "PCM".

AD Switch (For DTV only): Press [▶] or [OK] to enter submenu. Press [◀▶] to select the audio descriptor to "On" or "Off" as well as adjust the volume of the AD.

TIME menu

Press [MENU] to display the main menu.

Press [◀▶] to select "TIME" in the main menu, then press [▼] or [OK] to enter.

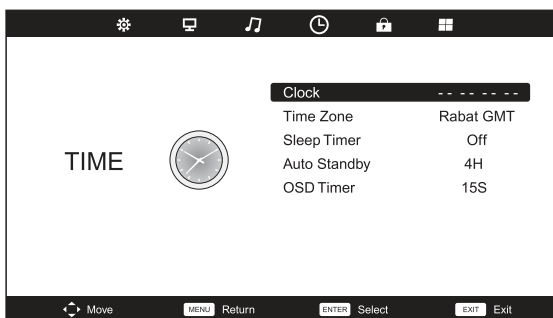

Clock: Use the ◀/▶ buttons to select the position, and use the [▲▼] buttons to set the time.

Note: User can not change time manually during DTV mode, for time is from signal source directly.

Time Zone: Press [OK] to enter submenu. Press [◀▶▼▲] to select items, press [OK] to confirm.

Sleep Timer: Press [▶] or [OK] to enter "Sleep Timer" submenu. Press [▲▼] to change the sleep timer as Off, 15Min, 30 Min, 45 Min, 60 Min, 90 Min, 120 Min, 240 Min.

You can press [SLEEP] repeatedly on the remote control to change the sleep timer directly.

Auto Standby: Press [OK] to enter submenu. Press [▲▼] to select Off, 3 H, 4 H, 5 H, press [OK] to confirm.

OSD Timer: Press [▶] or [OK] to enter submenu. Press [▲▼] to change the OSD timer as 5 Seconds, 15 Seconds, 30 Seconds.

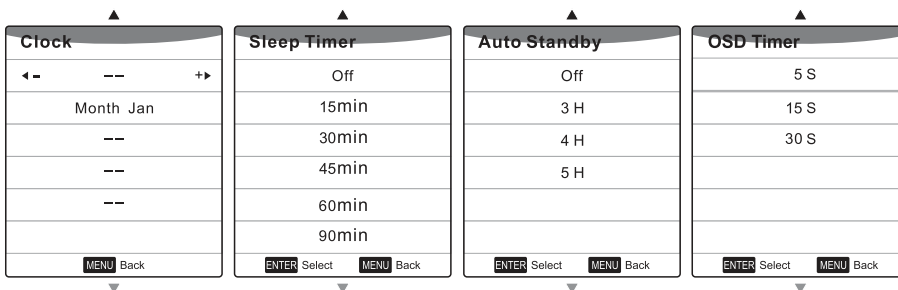

OPERATION OF FUNCTION MENU

LOCK menu

Press [MENU] to display the main menu.

Press [◀▶] to select "LOCK" in the main menu, then press [▼] or [OK] to enter.

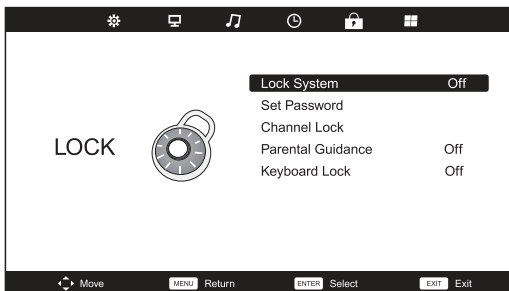

Password: Enter the default password "0000" to go to the LOCK function menu if you have set "Lock System" to "On".

Lock System: Set the lock system to "On" or "Off" which enables or disables below lock functions.

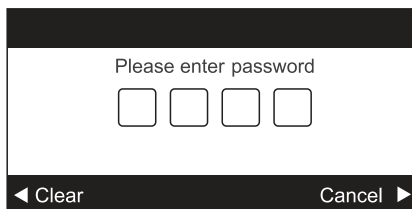

Set Password: Press [▶] or [OK] to enter submenu to set new password.

You can change the password by entering the old and a new password and then re-entering it to confirm the new one.

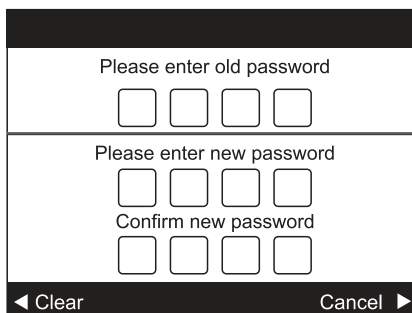

Channel Lock : Press [OK] to display Channel Lock menu.

Parental Guidance: Press [OK] to display submenu, press [▲/▼] to select Off, 3, 4, 5, 6, 7, 8, 9, 10, 11, 12, 13, 14, 15, 16, 17, 18. Press [OK] to confirm.

Keyboard Lock: Press [OK] to select Off or On.

SETUP menu

Press [MENU] to display the main menu.

Press [◀▶] to select "SETUP" in the main menu, then press [▼] or [OK] to enter.

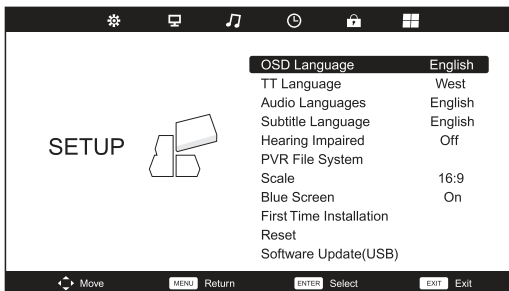

OPERATION OF FUNCTION MENU

OSD Language

Press OK button to enter and [◀▶▼▲] button to select OSD language.

Press "MENU" button to return to the previous menu.

TT Language: Press [OK] to enter submenu, press [▼/▲] to select items. Press [OK] to confirm.

Audio Languages / Subtitle Language: Press [OK] to enter submenu, press [◀▶▼▲] to select items. Press [OK] to confirm.

Hearing Impaired (For DTV only):

Press [◀▶] or [OK] to set the hearing impaired to "On" or "Off".

PVR File System (For DTV only):

Press [▶] or [OK] to enter the submenu to check the USB connected and provide with the recording function.

Scale: Press [OK] to enter submenu, press [▼/▲] to select the aspect ratio mode. Press [OK] to confirm.

Blue Screen

Press OK button to select On or Off.

First Time Installation: Press [▶] or [OK] to enter relevant options including OSD Language and Country.

Reset

This will reset all settings to default. Press OK button to start - you will be asked to confirm (see screenshot right).

Press "◀/▶" button to select Yes or No.

Press "MENU" or "EXIT" button to return.

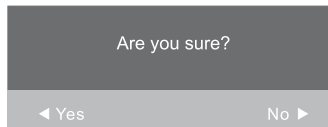

Software Update(USB) : Press [▼/▲] to select Software Update item. Press [OK] to confirm.

Note: User only on advice from Customer Support.

SATELLITE (Optional)

Press [SOURCE] button on the remote control to select Satellite item, then press [OK] button to confirm.

Press [MENU] button to display the main menu, then press [◀/▶] button to select 'CHANNEL' menu, press [OK] button to enter, and press [▼/▲] button to select Dish Setup item, then press [OK] button to enter Dish Setup submenu.

Shown as below:

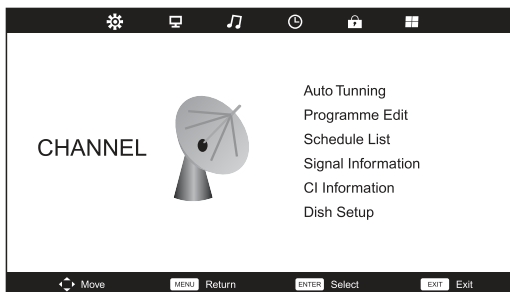

Note: CI Information is option.

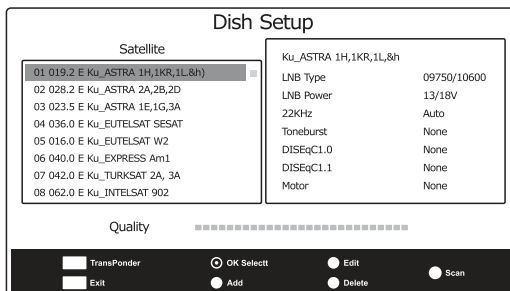

According to menu display, press [◀▶▼▲] button to function items, then press [OK] button to confirm. Press [Exit] button to exit.

OPERATION OF FUNCTION MENU

USB menu

Press "SOURCE" button to POP-UP the input source menu.

Press [▲/▼] button to select "Media" and press "OK" button to enter the interface, as shown right:

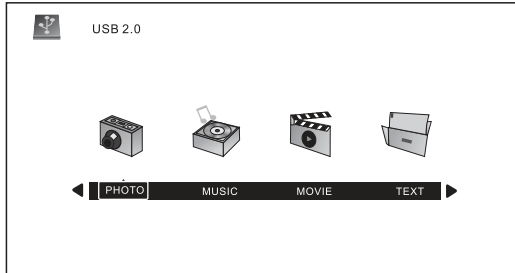

Press [◀/▶] button to select among the "PHOTO", "MUSIC", "MOVIE" and "TEXT" icons. Press "OK" button to confirm and enter the next menu, as shown right:

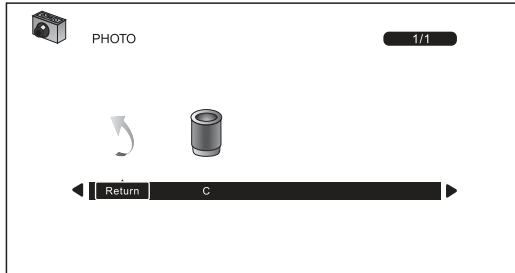

PHOTO

Press OK to select files (indicated with a checkmark) for selective playback (see 6 below).

1. Press [◀/▶] button to select "PHOTO".
2. Press "OK" button to enter the disk selection menu.
3. Press [◀/▶] button to select disk to enter the submenu. Select ↶ item to return to the previous menu.
4. Press [◀▶▼▲] button to select the image file you want to play. Press OK to select files (indicated with a checkmark) for selective playback. Press red button, you will enter the submenu to delete the file.
5. Press "PLAY" button to play photo slideshow (of checkmarked files; if no files are ticked, all pictures will play), press "OK" button to display menu.

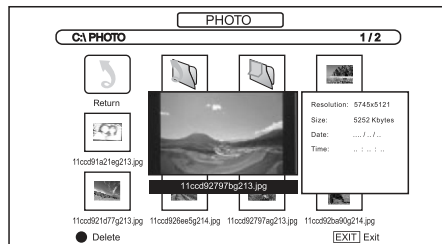
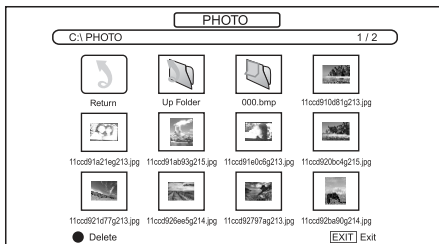

Pause

Press "PAUSE" button to pause the slideshow.

Play

Press "PLAY" button to play the selected photo.

Stop

Press "STOP" button to stop and return.

Next/Prev.

Press "NEXT" or "PREV." button to skip to view the photo which are selected the photo.

Exit

Press "EXIT" button to exit.

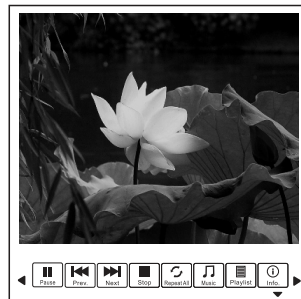

OPERATION OF FUNCTION MENU

MUSIC

1. Press [◀/▶] button to select "MUSIC".
2. Enter the music interface, press [◀▶▼▲] button to preview the music, as shown right:

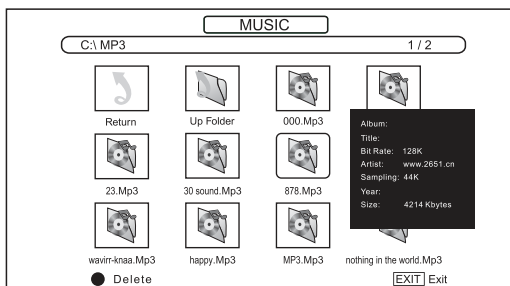

3. Press "PLAY" button into music player and playing the selected music, as shown below:

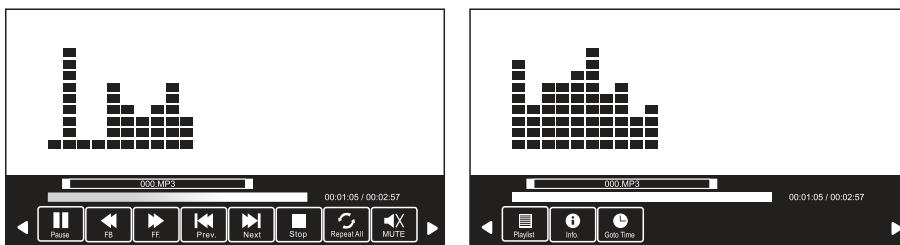

- PAUSE** Select "PAUSE" to pause the playing music.
- PLAY** Select "PLAY" to play the music.
- FB** Select "FB" to fast reverse among 2X, 4X, 8X and 16X modes.
- FF** Select "FF" to fast forward among 2X, 4X, 8X and 16X modes.
- PREV.** Select "PREV." to skip to previous track.
- NEXT** Select "NEXT" to skip to next track.
- STOP** Select "STOP" to stop and return.
- RepeatALL** Select "Repeat" to repeat play music (Repeat 1, Repeat All, Repeat None).
- MUTE** Select "MUTE" to turn off the sound.
- Playlist** Select "Playlist" to display play list.
- Info.** Select "Info" to display the music information.
- Goto Time** Select "Goto Time" to setup play time.

MOVIE

1. Press [◀/▶] button to select "MOVIE".
2. Enter the movie interface, Press [◀▶▼▲] button to preview the files, as shown right:
3. Press "PLAY" button to play the movie. Press OK button to display menu. Press the "PLAY" button once more to play the movie full-screen. Press the "PAUSE" button to pause the playing movie. Press "PREV." or "NEXT" button to skip the backward or forward. Press "FB" or "FF" button to fast reverse or fast forward, press "STOP" or "EXIT" button to return.

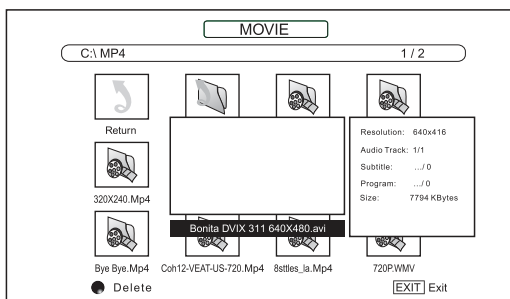

OPERATION OF FUNCTION MENU

TEXT

1. Press [◀/▶] button to select "TEXT" (to view text documents stored on USB).
2. Enter the text interface, Press [◀▶▼▲] button to preview the files, as shown below:

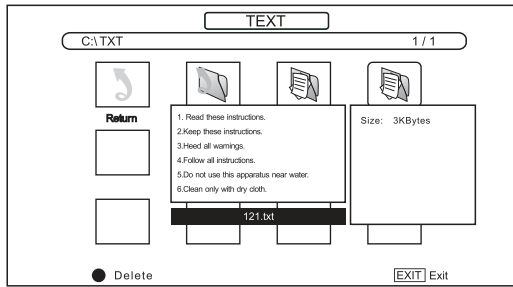



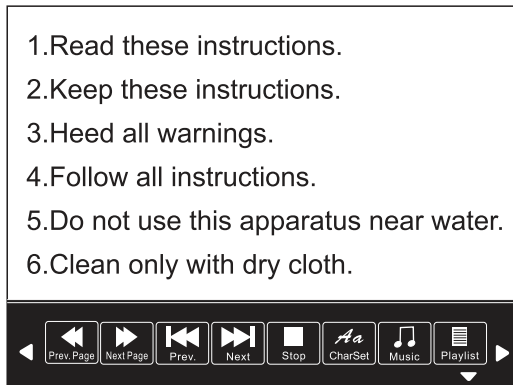





3. Press "PLAY" button to open and play the file, press OK button to display menu. as shown below.:
Select "Prev Page" to view a next page.
Select "Next Page" to view a previous page.
Select "STOP" to return.
Select "Music" to listen to music while reading.

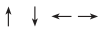

OPERATION OF FUNCTION MENU

MULTIMEDIA

Key function list

	Stop Playback		
	direction key (record program detailed information)		
INFO 	show details		
	Play		fast foward
	Pause		Previous
	fast reverse		Next
RED	Delete		
OK(ENTER)	Confirm		
EXIT	Exit		
SUBTITLE	When playing the movies, turn on or off the SUBTITLE function need the support of the movies' source.		

Note: Please use high-speed mobile disk

The following are the function interfaces of the PHOTO, MUSIC, MOVIE and TEXT. About their functions described please refer to the Key function list in page 19.

PHOTO



MUSIC



MOVIE



TEXT



TROUBLE SHOOTING GUIDE

Many apparent malfunctions are caused slight misadjustments of the regular controls of your unit or equally simple causes. If any difficulty arises through normal use of your unit, check the list of common problems in the list below.

If the problem persists, unplug your unit and contact your dealer.

SYMPTOM	METHODS OF CHECKING OR ADJUSTING
No picture or sound	Check the AC plug is in the socket. Check house circuit breaker is in the ON position.
Picture normal but no sound	Check that the volume is not at its minimum setting or on MUTE.
Remote control not working	Check that TV set power is ON. Check batteries are operational and inserted correctly. Make sure infrared receiving window on TV is not exposed to strong lighting or blocked in any way.
Cannot receive any TV signal	Ensure SOURCE switch is set to TV. Check aerial location and connection. Re-check your tuning method.
No program signals output from external source	Check SOURCE button to make sure it is in the correct position for reception.
Contrast and brightness problems	Make necessary adjustments to relevant settings.
Intermittent poor contrast and colour fading on all channels	Check aerial positioning
Dotted lines or stripes appear on screen	There may be Interference from another electrical product. Move appliance if it persists.
Snow on screen	Check aerial for broken circuit, loose connection or any visible damage.
Double images or 'ghosting'	Check aerial location and direction - strong winds may cause it to move. Also check whether mountains or tall buildings may be the problem. Minor adjustment of the direction of your antenna should keep the ghosting to a minimum.

Note: External rooftop/antenna adjustment should be left to a suitably qualified person.

ALL RIGHTS RESERVED, COPYRIGHT DENVER A/S



Denver.eu



Electric and electronic equipment and included batteries contains materials, components and substances that can be hazardous to your health and the environment, if the waste material (discarded electric and electronic equipment and batteries) is not handled correctly.

Electric and electronic equipment and batteries is marked with the crossed out trash can symbol, seen below. This symbol signifies that electric and electronic equipment and batteries should not be disposed of with other household waste, but should be disposed of separately.

As the end user it is important that you submit your used batteries to the appropriate and designated facility. In this manner you make sure that the batteries are recycled in accordance with legislature and will not harm the environment.

All cities have established collection points, where electric and electronic equipment and batteries can either be submitted free of charge at recycling stations and other collection sites, or be collected from the households. Additional information is available at the technical department of your city.

Please enter: Denver.eu and then click the search ICON on topline of website.

Write modelnumber:LED-2472

Now enter product page, and red directive is found under downloads/other downloads.

Operating Frequency Range: 43.5MHz ~ 858MHz

Max Output Power: 40W

DENVER A/S
Omega 5A, Soeften
DK-8382 Hinnerup
Denmark
Denver.eu



ENERG



Denver

LED-2472



21 kWh/1000h

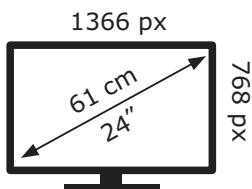

2019/2013

