

# GP1S21/GP1S22

## Subminiature Photointerrupter

### ■ Features

1. Ultra-compact
2. PWB mounting type package
3. High sensing accuracy  
( Slit width ; **GP1S21** : 0.8mm  
**GP1S22** : 0.3mm )

### ■ Applications

1. Cameras
2. Floppy disk drives

### ■ Outline Dimensions

(Unit : mm )

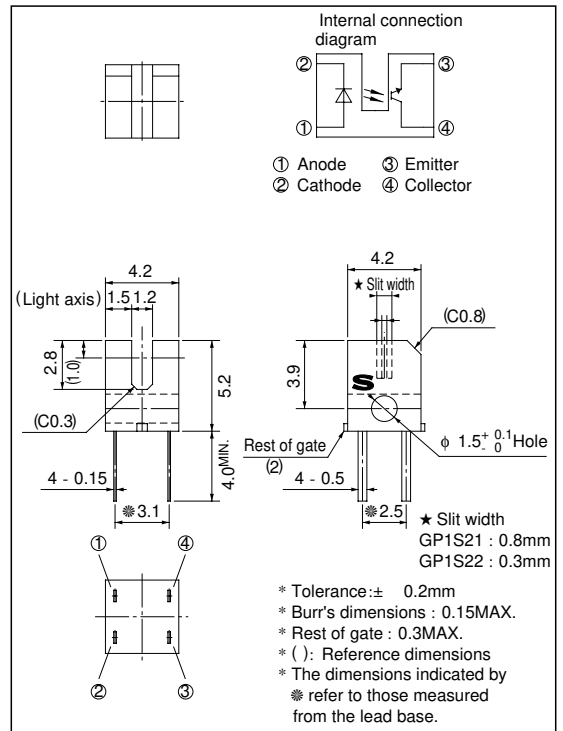

### ■ Absolute Maximum Ratings

(Ta = 25°C)

	Parameter	Symbol	Rating	Unit
Input	Forward current	I <sub>F</sub>	50	mA
	Reverse voltage	V <sub>R</sub>	6	V
	Power dissipation	P	75	mW
Output	Collector-emitter voltage	V <sub>CEO</sub>	35	V
	Emitter-collector voltage	V <sub>ECO</sub>	6	V
	Collector current	I <sub>C</sub>	20	mA
	Collector power dissipation	P <sub>C</sub>	75	mW
	Total power dissipation	P <sub>tot</sub>	100	mW
	Operating temperature	T <sub>opr</sub>	- 25 to + 85	°C
	Storage temperature	T <sub>stg</sub>	- 40 to + 100	°C
	*1 Soldering temperature	T <sub>sol</sub>	260	°C

\*1 For 5 seconds

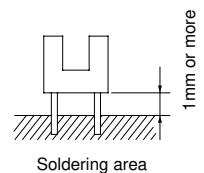

**■ Electro-optical Characteristics**

( $T_a = 25^\circ\text{C}$ )

Parameter		Symbol	Conditions	MIN.	TYP.	MAX.	Unit
Input	Forward voltage	$V_F$	$I_F = 20\text{mA}$	-	1.2	1.4	V
	Reverse current	$I_R$	$V_R = 3\text{V}$	-	-	10	$\mu\text{A}$
Output	Collector dark current	$I_{CEO}$	$V_{CE} = 20\text{V}$	-	-	$1 \times 10^{-7}$	A
Transfer characteristics	Collector Current	<b>GP1S21</b>	$V_{CE} = 5\text{V}, I_F = 1.5\text{mA}$	27	-	260	$\mu\text{A}$
		<b>GP1S22</b>	$V_{CE} = 5\text{V}, I_F = 5\text{mA}$	100	-	1300	$\mu\text{A}$
	Collector-emitter saturation voltage	<b>GP1S21</b>	$I_F = 3\text{mA}, I_C = 27 \mu\text{A}$	-	-	0.4	V
		<b>GP1S22</b>	$I_F = 10\text{mA}, I_C = 50 \mu\text{A}$	-	-	0.4	V
	Response time	Rise time	$t_r$	$I_C = 0.1\text{mA}, V_{CE} = 5\text{V}, R_L = 1\text{k}\Omega$	-	50	150
Fall time		$t_f$	-		50	150	$\mu\text{s}$

**Fig. 1 Forward Current vs. Ambient Temperature**

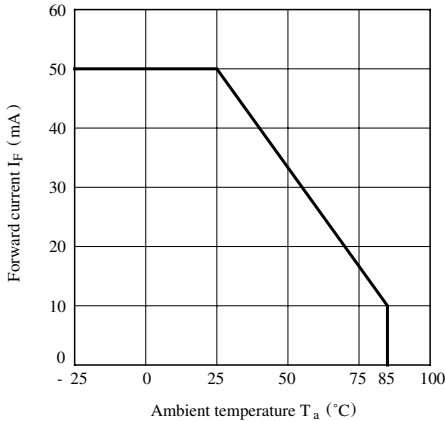

**Fig. 2 Power Dissipation vs. Ambient Temperature**

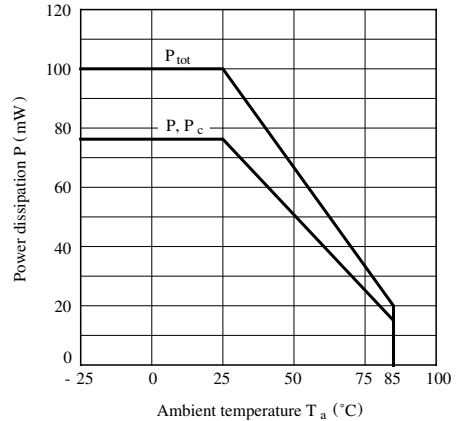

**Fig. 3 Forward Current vs. Forward Voltage**

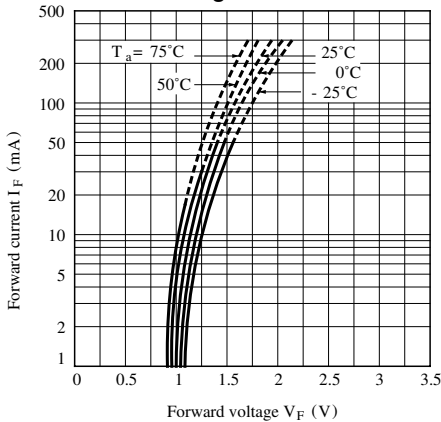

**Fig. 4 Collector Current vs. Forward Current**

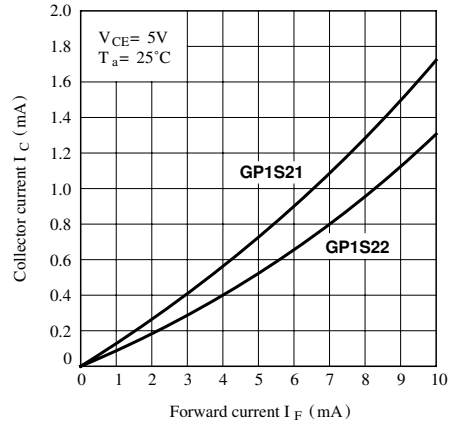

**Fig. 5-a Collector Current vs. Collector-emitter Voltage (GP1S21)**

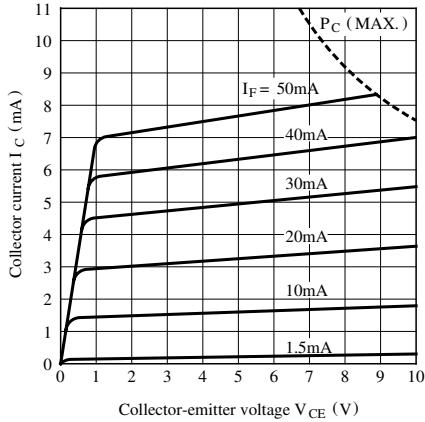

**Fig. 5-b Collector Current vs. Collector-emitter Voltage (GP1S22)**

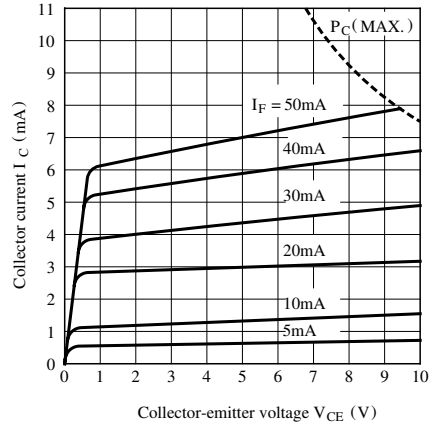

**Fig. 6 Collector Current vs. Ambient Temperature**

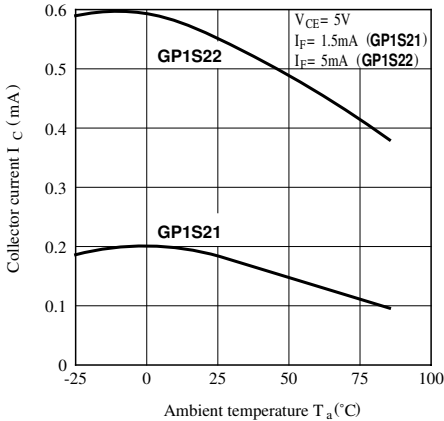

**Fig. 7 Collector-emitter Saturation Voltage vs. Ambient Temperature**

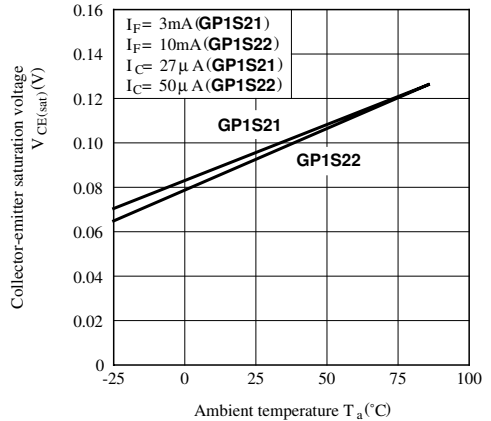

**Fig. 8 Response Time vs. Load Resistance**

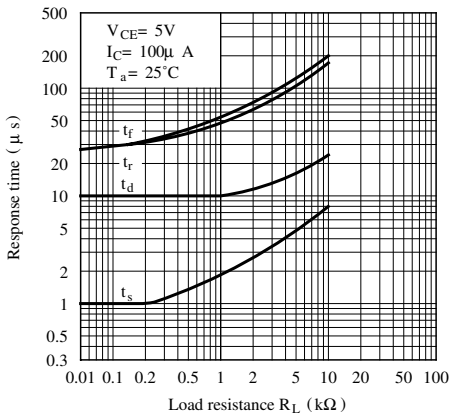

**Test Circuit for Response Time**

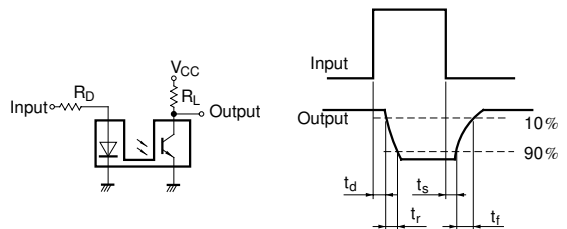

**Fig. 9 Collector Dark Current vs. Ambient Temperature**

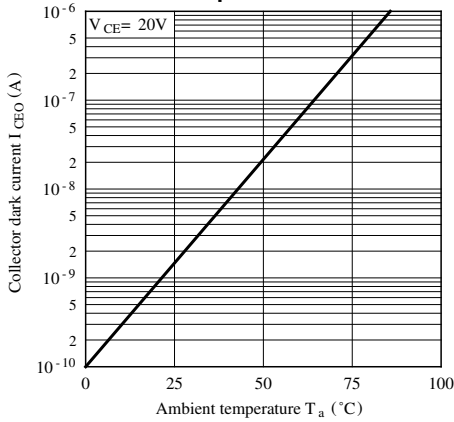

**Fig. 10-a Relative Collector Current vs. Shield Distance (1) (GP1S21)**

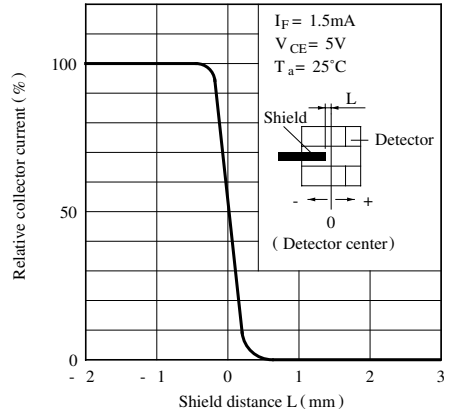

**Fig.10-b Relative Collector Current vs. Shield Distance (1) (GP1S22)**

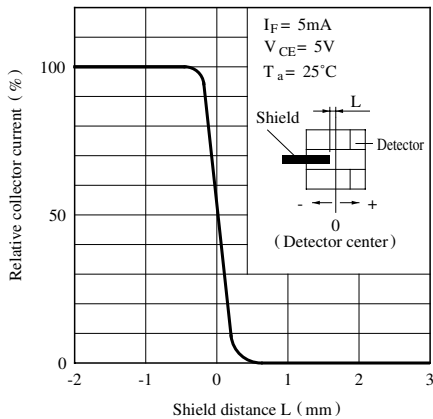

**Fig.11 Relative Collector Current vs. Shield Distance (2)**

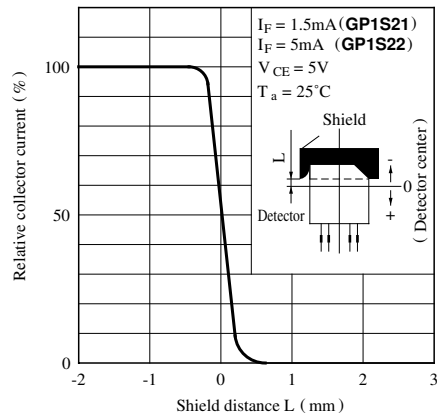

● Please refer to the chapter “Precautions for Use”.