



**Technical Data Sheet**  
**0.56'' Dual Digit Displays**

**ELD-512SYGWA/S530-E2**

■ **Features :**

- Industrial standard size.
- Low power consumption.
- Categorized for luminous intensity.
- Pb free

■ **Descriptions :**

- The ELD-512 series is a large 14.22mm (0.56'')high seven segment display designed for viewing distances up to 7 meters.
- These displays provide excellent reliability in bright ambient light.
- These devices are made with white segments and gray surface.

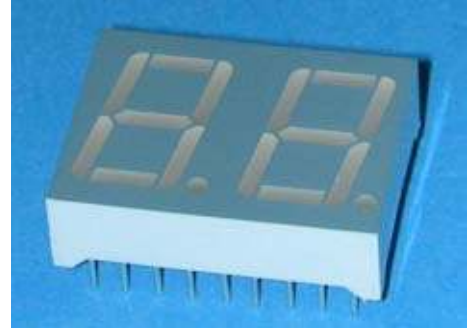

■ **Applications :**

- Audio equipment
- Instrument panels
- Digital read out display

PART NO.	Chip	
	Material	Emitted Color
ELD-512SYGWA/S530-E2	AlGaInP	Super Yellow Green

CG0410092 61028600



Technical Data Sheet  
0.56" Dual Digit Displays

ELD-512SYGWA/S530-E2

Package Dimensions

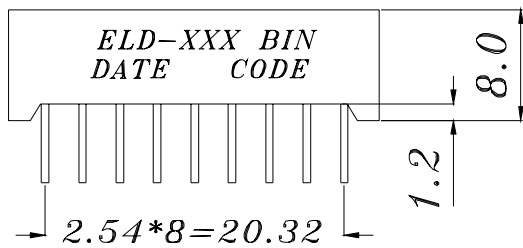
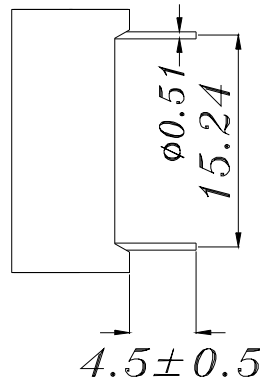
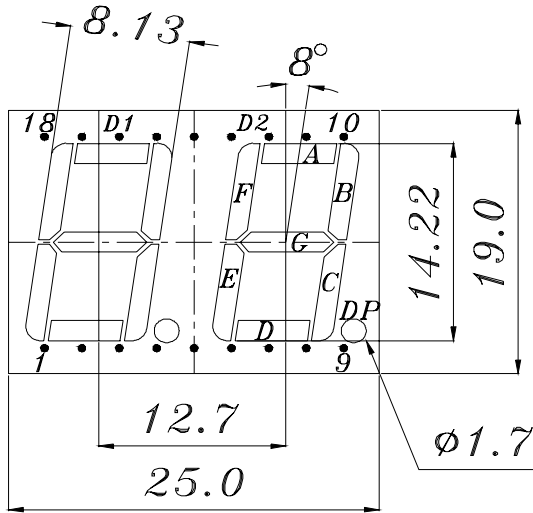

- COMMON ANODE
- 1 CATHODE E D1
  - 2 CATHODE D D1
  - 3 CATHODE C D1
  - 4 CATHODE DP D1
  - 5 CATHODE E D2
  - 6 CATHODE D D2
  - 7 CATHODE G D2
  - 8 CATHODE C D2
  - 9 CATHODE DP D2
  - 10 CATHODE B D2
  - 11 CATHODE A D2
  - 12 CATHODE F D2
  - 13 COMMON ANODE D2
  - 14 COMMON ANODE D1
  - 15 CATHODE B D1
  - 16 CATHODE A D1
  - 17 CATHODE G D1
  - 18 CATHODE F D1

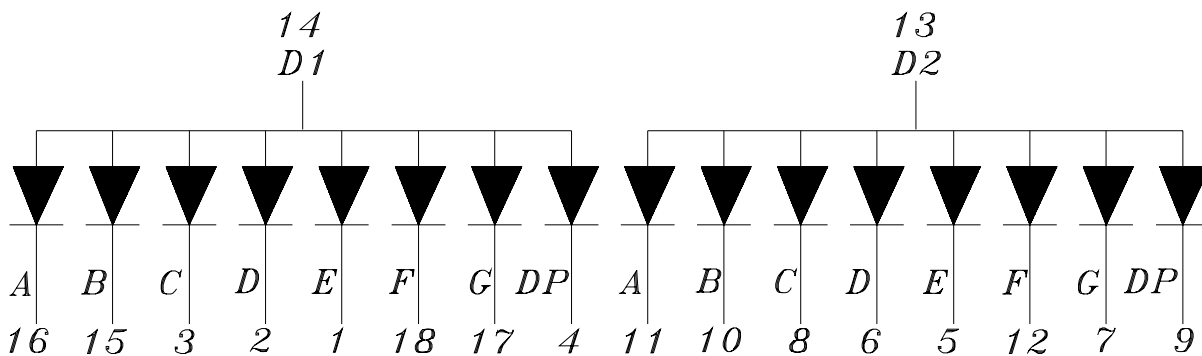

- Notes:**
1. All dimensions are in millimeters, tolerance is 0.25mm unless otherwise noted.
  2. Above specification may be changed without notice.
- Supplier will reserve authority on material change for above specification.

**Technical Data Sheet  
0.56" Dual Digit Displays****ELD-512SYGWA/S530-E2**

## ■ Absolute maximum ratings at Ta = 25°C :

Parameter	Symbol	Rating	Unit
Reverse Voltage	V <sub>R</sub>	5	V
Forward Current	I <sub>F</sub>	25	mA
Operating Temperature	T <sub>opr</sub>	-40 to +85	°C
Storage Temperature	T <sub>stg</sub>	-40 to +100	°C
Soldering Temperature	T <sub>sol</sub>	260 ± 5	°C
Electrostatic Discharge	ESD	2000	V
Power Dissipation	P <sub>d</sub>	60	mW
Peak Forward Current(Duty 1/10 @ 1KHZ)	I <sub>F(Peak)</sub>	60	mA

## ■ Electronic optical characteristics :

Parameter		Symbol	Min.	Typ.	Max.	Unit	Condition
Luminous Intensity	Per segment	I <sub>v</sub>	----	1.2	----	mcd	I <sub>F</sub> =2mA
			2.8	6.4	----		I <sub>F</sub> =10mA
	Per decimal point	I <sub>v</sub>	----	0.4	----	mcd	I <sub>F</sub> =2mA
			0.7	1.5	----		I <sub>F</sub> =10mA
Peak Wavelength		λ <sub>p</sub>	----	575	----	nm	I <sub>F</sub> =20mA
Dominant Wavelength		λ <sub>d</sub>	----	573	----	nm	I <sub>F</sub> =20mA
Spectrum Radiation Bandwidth		Δλ	----	20	----	nm	I <sub>F</sub> =20mA
Forward Voltage		V <sub>F</sub>	-----	2.0	2.4	V	I <sub>F</sub> =20mA
Reverse Current		I <sub>R</sub>	----	----	100	μA	V <sub>R</sub> =5V



Technical Data Sheet  
0.56" Dual Digit Displays

ELD-512SYGWA/S530-E2

■ Typical Electro-Optical Characteristic Curves:

CHIP Material:AlGaInP  
Emitted Color:Super Yellow Green

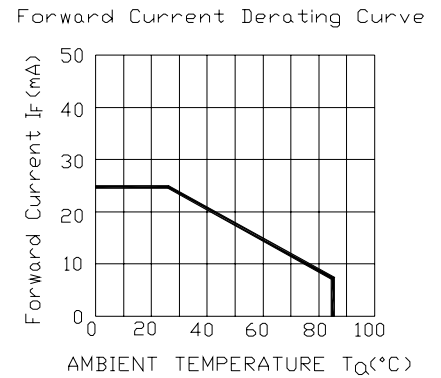
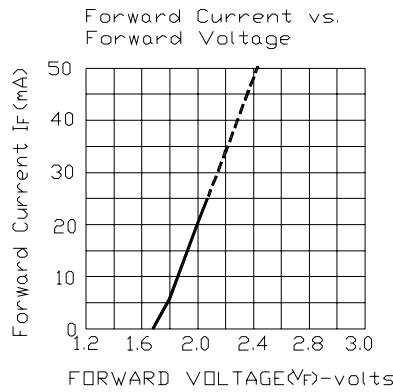
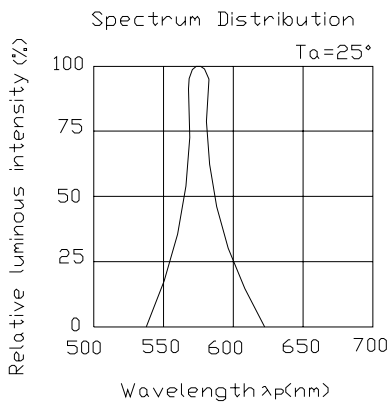

**Technical Data Sheet  
0.56" Dual Digit Displays****ELD-512SYGWA/S530-E2****■ Reliability test items and conditions:**

NO	Item	Test Conditions	Test Hours/Cycle	Sample Size	Ac/Re
1	Solder Heat	TEMP : 260°C ± 5 °C	5 SEC	76 PCS	0/1
2	Temperature Cycle	H : +85°C 30min ∫ 5 min L : -55°C 30min	50 CYCLE	76 PCS	0/1
3	Thermal Shock	H : +100°C 5min ∫ 10 sec L : -10°C 5min	50 CYCLE	76 PCS	0/1
4	High Temperature Storage	TEMP : 100°C	1000 HRS	76 PCS	0/1
5	Low Temperature Storage	TEMP : -55°C	1000 HRS	76 PCS	0/1
6	DC Operating Life	IF = 10 mA	1000 HRS	76 PCS	0/1
7	High Temperature / High Humidity	85°C/85% RH	1000 HRS	76 PCS	0/1