

2. PARTS DESCRIPTION

2.1 BOX CONTENT

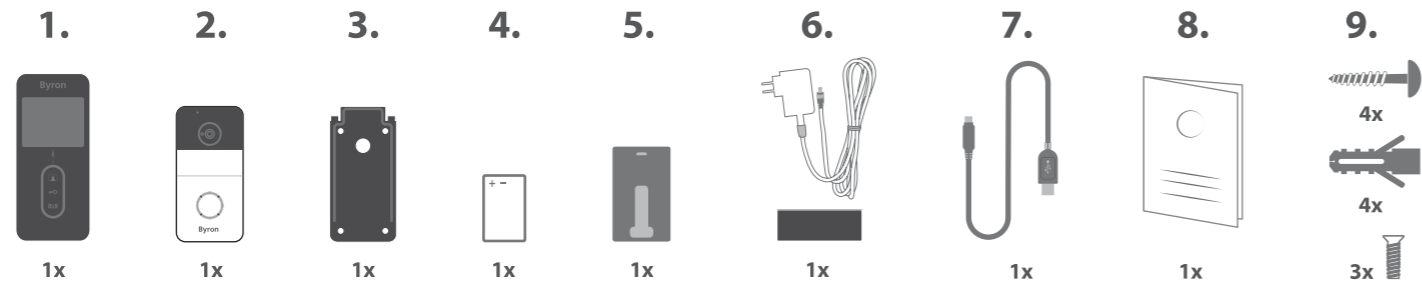

2.2.1 INDOOR UNIT (MONITOR)

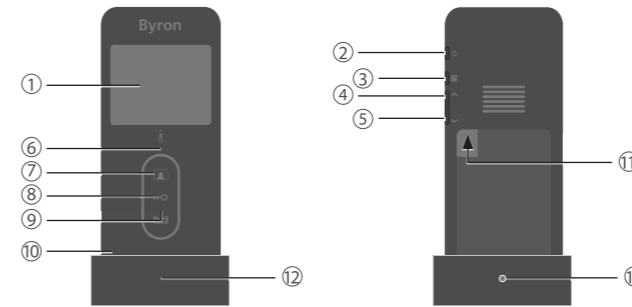

2.2.2 OUTDOOR UNIT (DOORBELL)

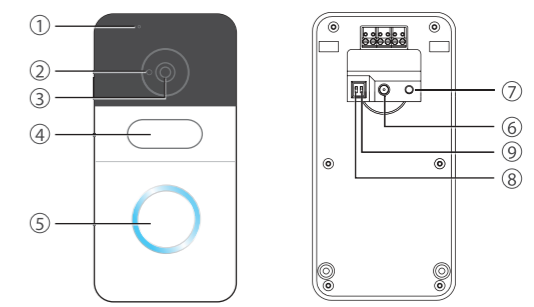

3. INSTALLATION

3.1 PLACING THE INDOOR UNIT (MONITOR)

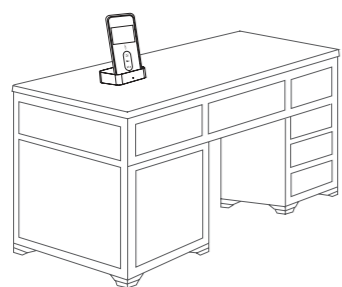

3.2 MOUNT THE OUTDOOR UNIT (DOORBELL)

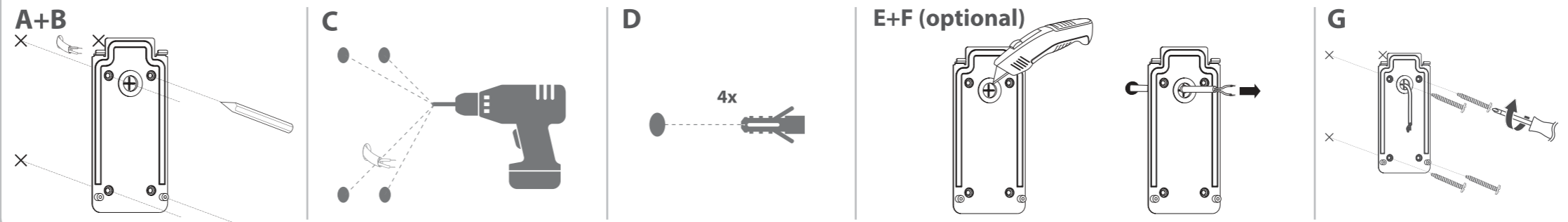

3.2 MOUNT THE OUTDOOR UNIT (DOORBELL)

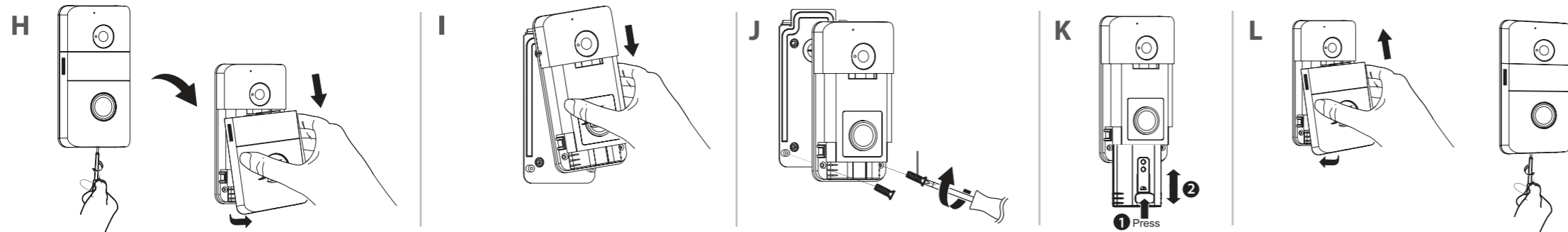

3.3.1 CONNECTING AC POWER TO THE INDOOR UNIT

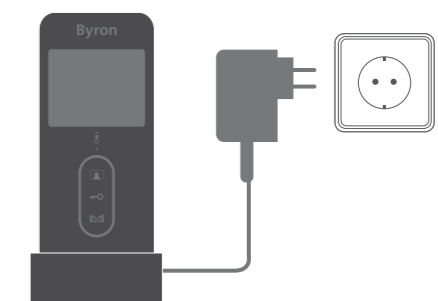

3.3.2 INSTALLING AND CHARGING THE INDOOR UNIT (MONITOR) BATTERY

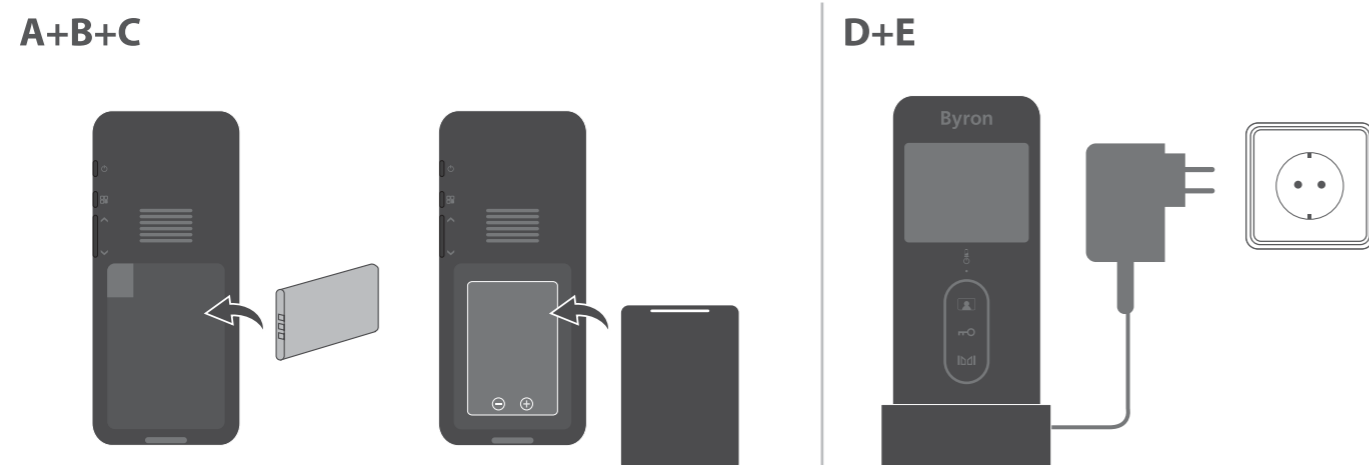

3.3.3 CHARGING OUTDOOR UNIT (DOORBELL) BATTERY

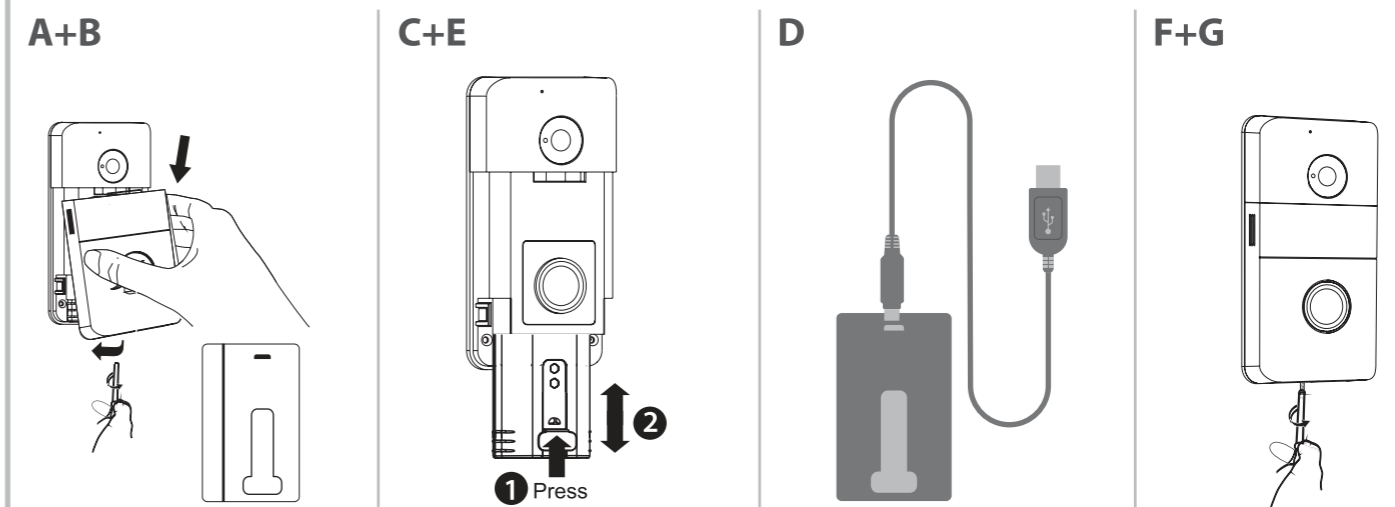

3.3.4 CONNECTING AC POWER TO THE OUTDOOR UNIT (OPTIONAL, ADAPTER NOT INCLUDED)

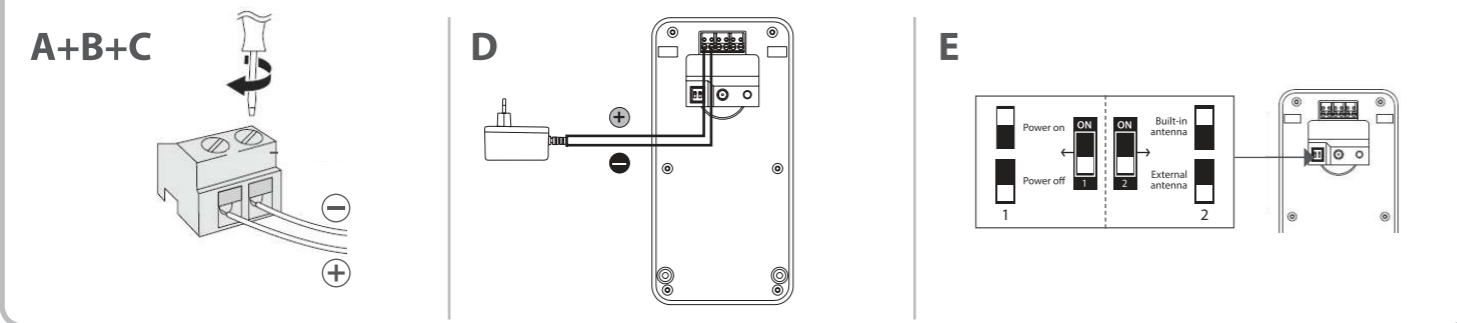

3.3.5 + 3.3.6 CONNECTING A DOOR LOCK/GATE OPENER (NOT INCLUDED)

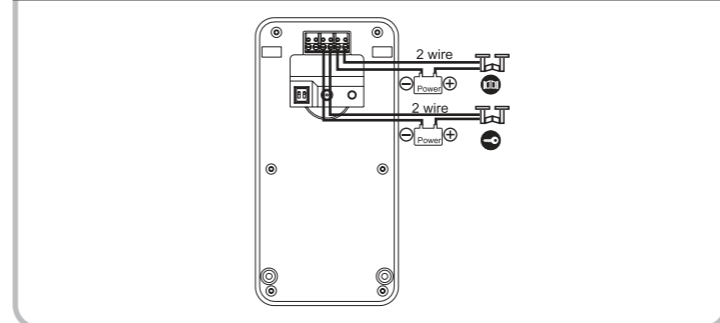

3.3.7 CONNECTING THE EXTERNAL ANTENNA (NOT INCLUDED)

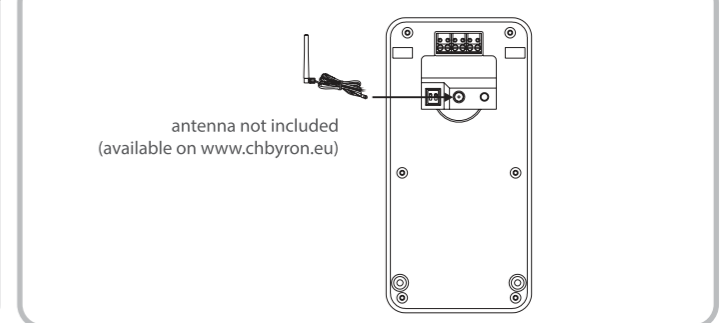

4. BASIC FUNCTIONS

4.1 SCREEN ICONS

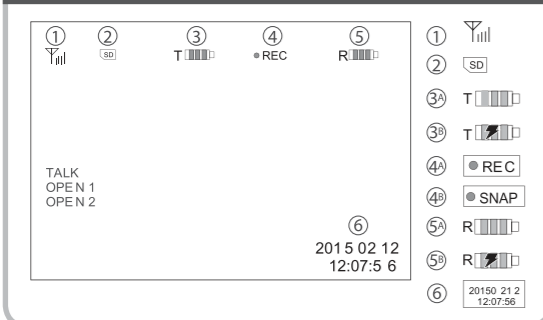

4.2 SETTINGS MENU

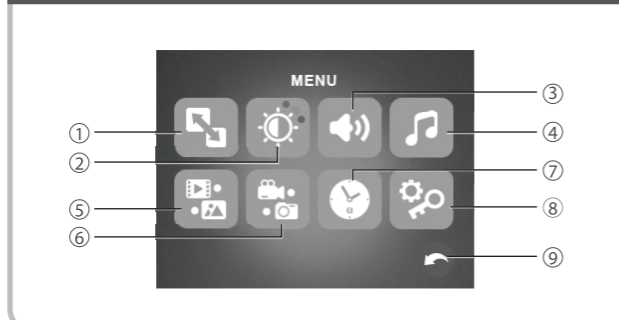

4.3 ANSWERING A CALL

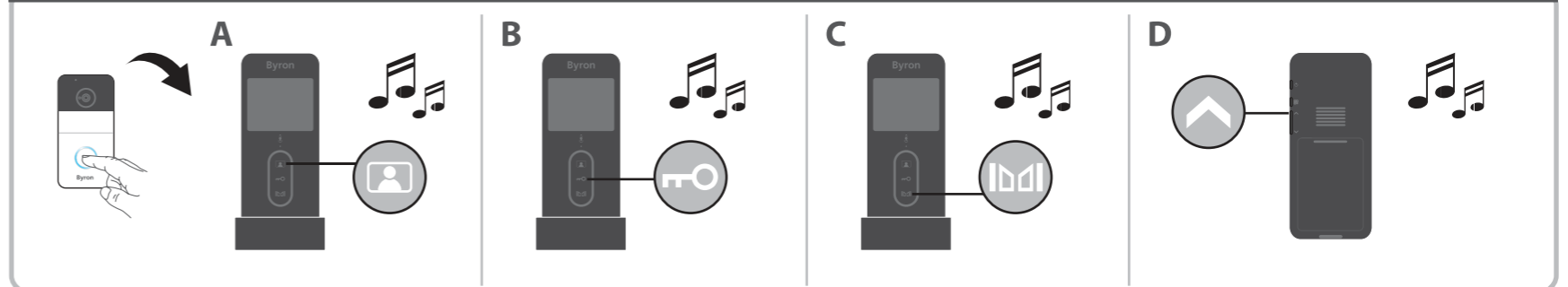

4.4 PAIRING THE MONITOR/DOORBELL (1 INDOOR UNIT MAX.)

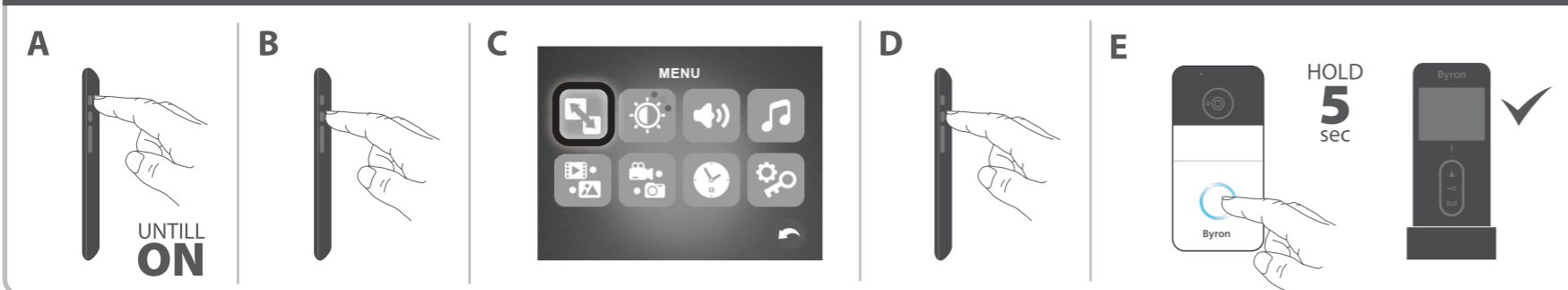

4.6 IMAGE SETTINGS

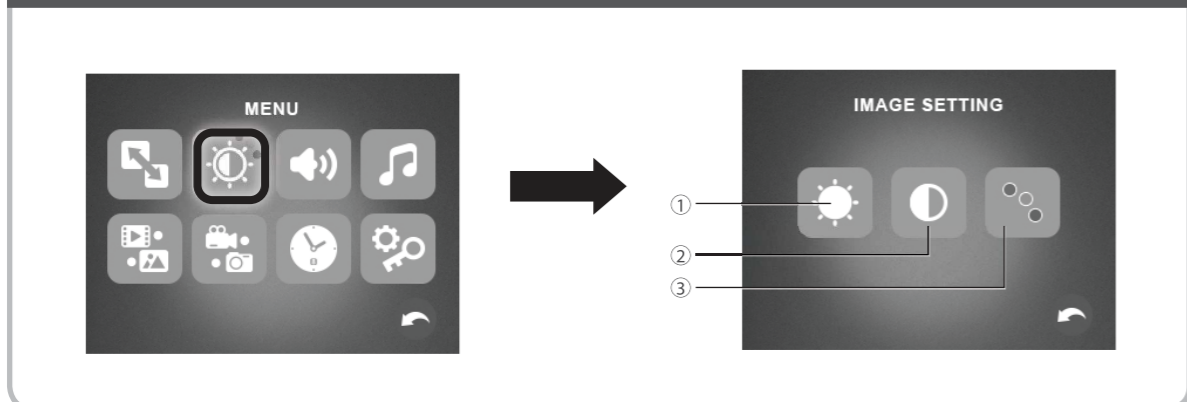

4.7 VOLUME CONTROL

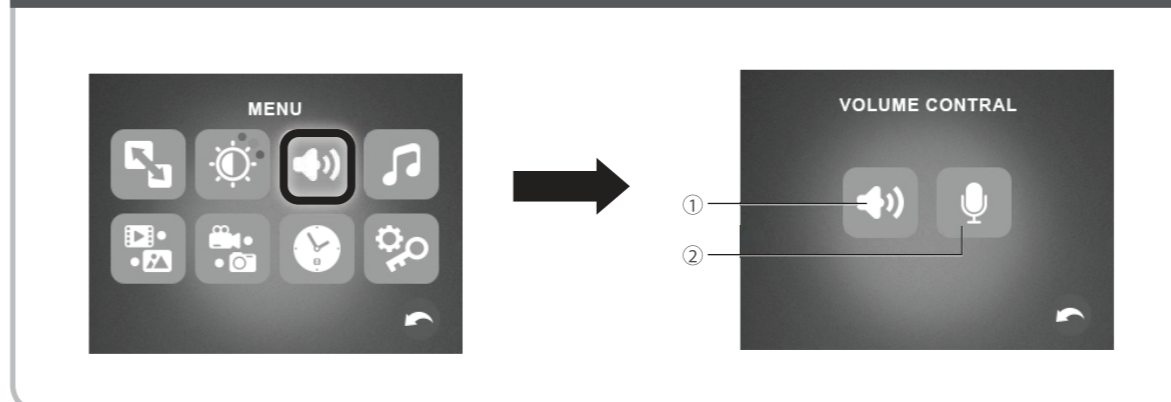

4.8 RINGTONE SETTINGS

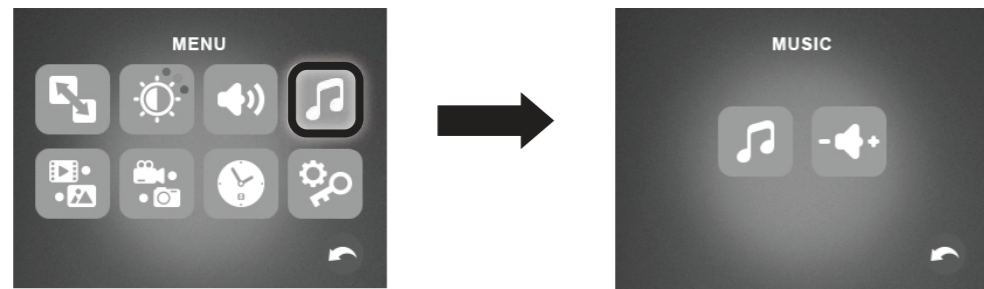

4.9 PLAYBACK MENU

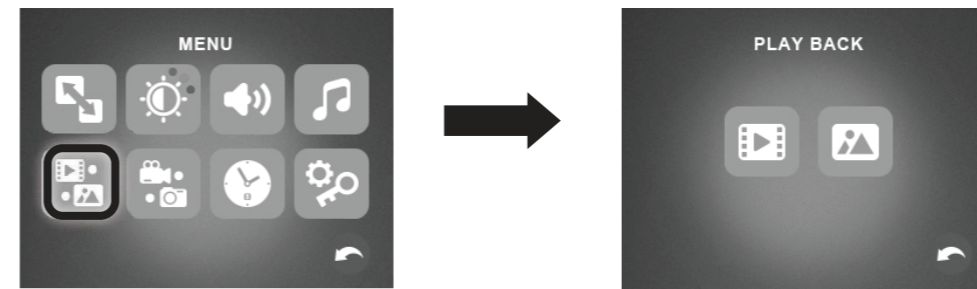

4.10 RECORDING VIDEOS/PHOTOS

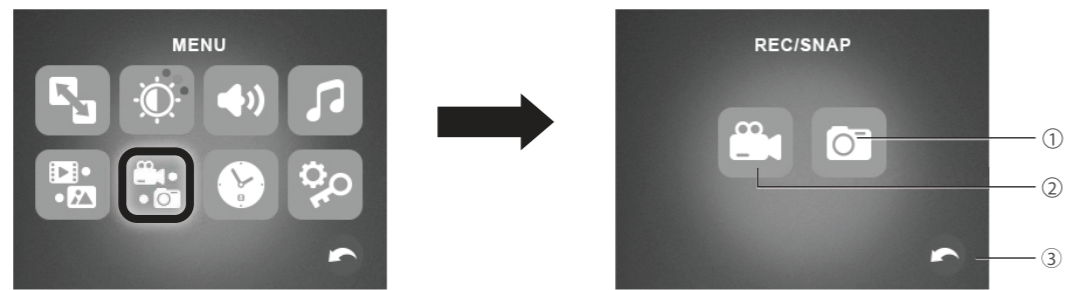

4.11 TIME SETTING

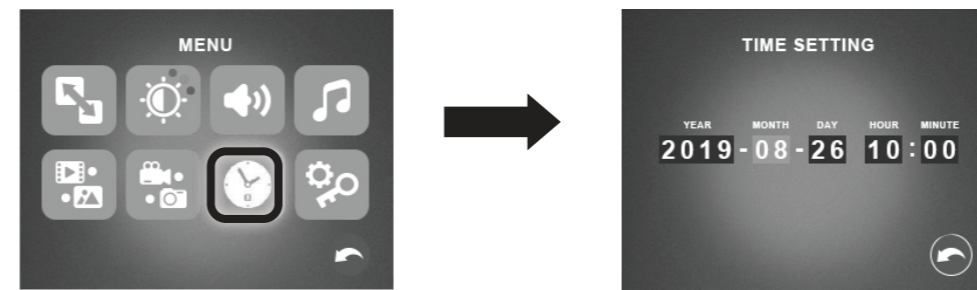

4.12 UNLOCK TIME SETTINGS

