

HFD3

SUBMINIATURE SIGNAL RELAY



File No.:E133481



File No.:40018867

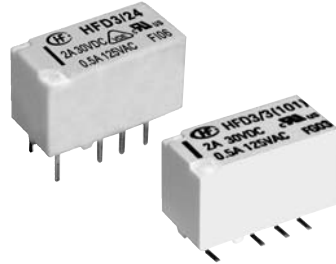

Features

- Surge withstand voltage up to 2500VAC, meets FCC Part 68 and Telecordia
- Meets EN60950 / EN41003
- SMT and DIP types available
- Bifurcated contacts
- Single side stable and latching type available
- Class A insulation system
- Environmental friendly product (RoHS compliant)
- Outline Dimensions: (15.0 x 7.5 x 9.0) mm

CONTACT DATA

Contact arrangement	2C
Contact resistance	50mΩ max.(at 0.1A 6VDC)
Contact material	AgNi + Au plated
Contact rating (Res. load)	2A 30VDC 0.5A 125VAC
Max. switching current	2A
Max. switching voltage	250VAC / 220VDC
Max. switching power	62.5VA / 60W
Min. applicable load ¹⁾	10mV 10μA
Mechanical endurance	1 x 10 ⁸ OPS
Electrical endurance	5 x 10 ⁵ OPS (at 1A 30VDC)
	1 x 10 ⁵ OPS (at 2A 30VDC)
	1 x 10 ⁵ OPS (at 0.5A 125VAC)

Notes: 1) Min. applicable load is reference value. Please perform the confirmation test with the actual load before production since reference value may change according to switching frequencies, environmental conditions and expected contact resistance and reliability.

SAFETY APPROVAL RATINGS

UL/CUL	0.3A 110VDC
	2A 30VDC
	0.5A 125VAC
VDE	2A 30VDC
	0.5A 125VAC

Notes: Only some typical ratings are listed above. If more details are required, please contact us.

CHARACTERISTICS

Insulation resistance	1000MΩ (at 500VDC)	
Dielectric strength	Between coil & contacts	2000VAC 1min ¹⁾
	Between open contacts	1000VAC 1min
	Between contact sets	1500VAC 1min
Surge withstand voltage		
Between open contacts (10 × 160μs)	1500VAC (FCC part 68)	
Between coil & contacts (2 × 10μs)	2500VAC (Telecordia)	
Operate time (Set time)	4ms max.	
Release time (Reset time)	4ms max.	
Ambient temperature	-40°C to 85°C	
Humidity	5% to 85% RH	
Vibration resistance	Functional	10Hz to 55Hz 3.3mm DA
	Destructive	10Hz to 55Hz 5.0mm DA
Shock resistance	Functional	735m/s ²
	Destructive	980m/s ²
Termination	DIP, SMT	
Unit weight	Approx. 2g	
Construction	Plastic sealed	

Notes: 1) If the Dielectric strength between coil & contacts requiring 3000VAC 1min for single side stable and 1 coil latching version, please mark Customer special code as (131), or order HFD3-V.

2) The data shown above are initial values.

COIL

Coil power	Single side stable	Approx. 140mW
	1 coil latching	Approx. 100mW
	2 coils latching	Approx. 200mW
Temperature rise	50K max.	



HONGFA RELAY

ISO9001, ISO/TS16949, ISO14001, OHSAS18001, IECQ QC 080000 CERTIFIED

2012 Rev. 1.00

COIL DATA

at 23°C

Single side stable

Order Number	Nominal Voltage VDC	Pick-up Voltage VDC max.	Drop-out Voltage VDC min.	Coil Resistance Ω	Nominal Power mW approx.	Max. Allowable Voltage VDC
HFD3/1.5	1.5	1.13	0.15	16 x (1±10%)	140	2.2
HFD3/3	3	2.25	0.3	64.3 x (1±10%)	140	4.5
HFD3/4.5	4.5	3.38	0.45	145 x (1±10%)	140	6.7
HFD3/5	5	3.75	0.5	178 x (1±10%)	140	7.5
HFD3/6	6	4.5	0.6	257 x (1±10%)	140	9
HFD3/9	9	6.75	0.9	579 x (1±10%)	140	13.5
HFD3/12	12	9	1.2	1028 x (1±10%)	140	18
HFD3/24	24	18	2.4	4114 x (1±10%)	140	36
HFD3/48	48	36	4.8	8533 x (1±10%)	270	57.6

1 coil latching

Order Number	Nominal Voltage VDC	Pick-up Voltage VDC max.	Drop-out Voltage VDC min.	Coil Resistance Ω	Nominal Power mW approx.	Max. Allowable Voltage VDC
HFD3/1.5-L1	1.5	1.13	1.13	22.5 x (1±10%)	100	2.7
HFD3/3-L1	3	2.25	2.25	90 x (1±10%)	100	5.4
HFD3/4.5-L1	4.5	3.38	3.38	203 x (1±10%)	100	8.1
HFD3/5-L1	5	3.75	3.75	250 x (1±10%)	100	9
HFD3/6-L1	6	4.5	4.5	360 x (1±10%)	100	10.8
HFD3/9-L1	9	6.75	6.75	810 x (1±10%)	100	16.2
HFD3/12-L1	12	9	9	1440 x (1±10%)	100	21.6
HFD3/24-L1	24	18	18	5760 x (1±10%)	100	43.2

2 coils latching

Order Number	Nominal Voltage VDC	Set Voltage VDC max.	Reset Voltage VDC max.	Coil Resistance Ω	Nominal Power mW approx.	Max. Allowable Voltage VDC
HFD3/1.5-L2	1.5	1.13	1.13	11.2 x (1±10%)	200	2.2
HFD3/3-L2	3	2.25	2.25	45 x (1±10%)	200	4.5
HFD3/4.5-L2	4.5	3.38	3.38	101 x (1±10%)	200	6.7
HFD3/5-L2	5	3.75	3.75	125 x (1±10%)	200	7.5
HFD3/6-L2	6	4.5	4.5	180 x (1±10%)	200	9.0
HFD3/9-L2	9	6.75	6.75	405 x (1±10%)	200	13.5
HFD3/12-L2	12	9	9	720 x (1±10%)	200	18
HFD3/24-L2	24	18	18	2880 x (1±10%)	200	36

Notes: 1) When user's requirements can't be found in the above table, special order allowed.

2) In case 5V of transistor drive circuit, it is recommended to use 4.5V type relay, and 3V to use 2.4V type relay.

ORDERING INFORMATION

Type		HFD3 /		24	-L2	S	R	(XXX)	
Coil voltage		1.5, 3, 4.5, 5, 6, 9, 12, 24, 48VDC ¹⁾							
Sort		L1: 1 coil latching		Nil: Single side stable					
		L2: 2 coils latching							
Terminal type		S: Standard SMT		S1: Short terminal SMT		Nil: DIP			
Packing style		R: Tape and reel packing (Only for SMT type) ²⁾					Nil: Tube packing		
Customer special code		(131): The Dielectric strength between coil & contacts is 3000VAC 1min for single side stable and 1 coil latching version.							

Notes: 1) 48VDC coil voltage is only for single side stable version.

2) For the R type, the letter "R" will only be printed on packing tag and will not appear on relay cover.

OUTLINE DIMENSIONS, WIRING DIAGRAM AND PC BOARD LAYOUT

Unit: mm

Outline Dimensions
(DIP type)

Single side stable & 1 coil latching

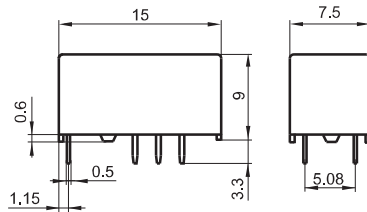

2 coils latching

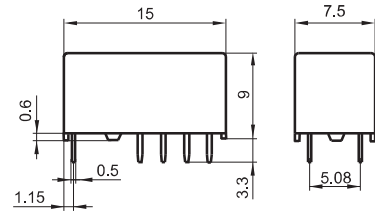

PCB Layout
(DIP type)
(Bottom view)

Single side stable & 1 coil latching

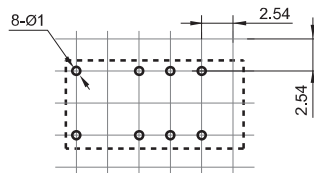

2 coils latching

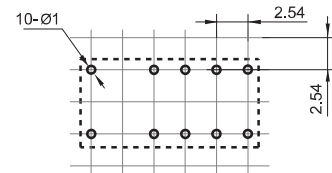

OUTLINE DIMENSIONS, WIRING DIAGRAM AND PC BOARD LAYOUT

Unit: mm

Outline Dimensions
(S type: Standard SMT)

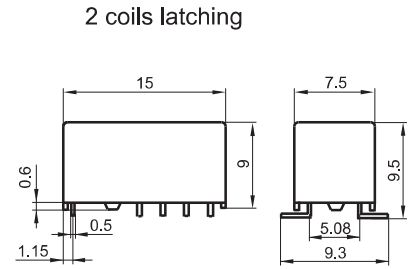
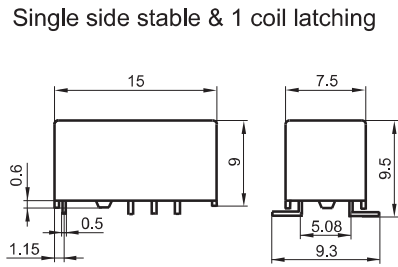

PCB Layout
(S type: Standard SMT)
(Bottom view)

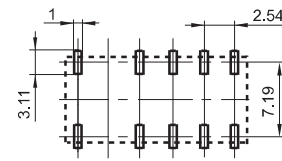
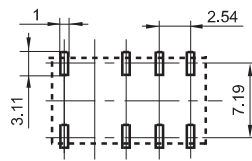

Outline Dimensions
(S1 type: Short terminal SMT)

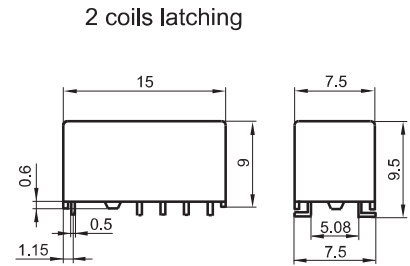
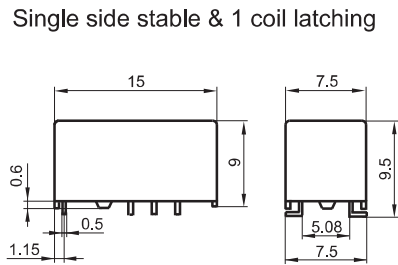

PCB Layout
(S1 type: Short terminal SMT)
(Bottom view)

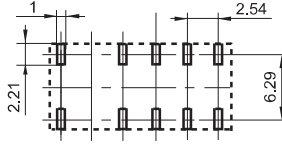
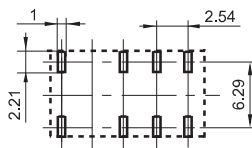

Wiring Diagram
(Bottom view)

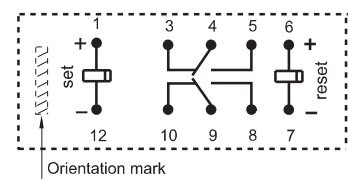
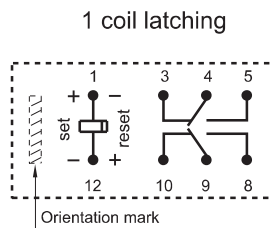
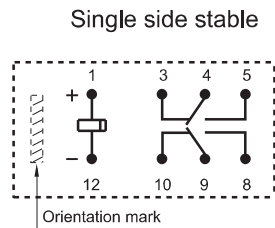

No energized condition

Reset condition

Reset condition

Direction of Relay Insertion

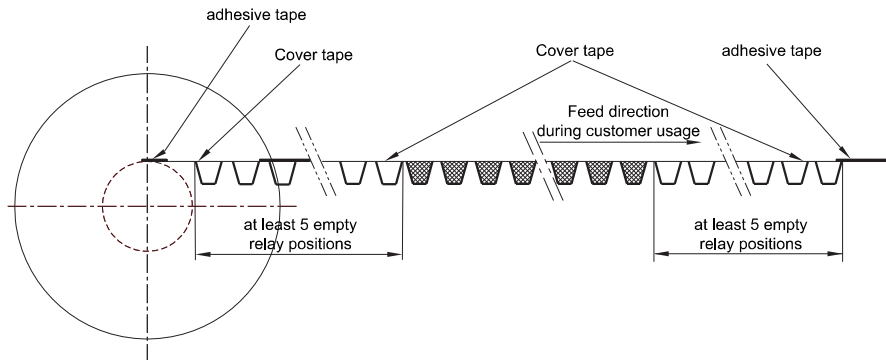
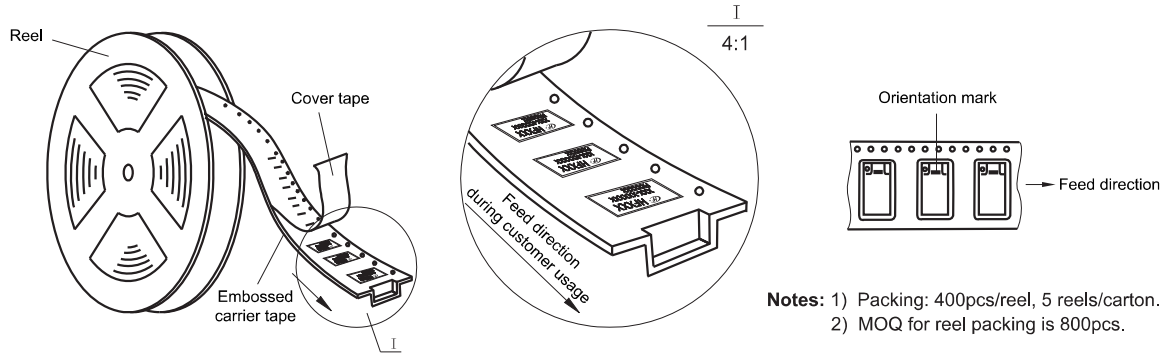

Reel Dimensions

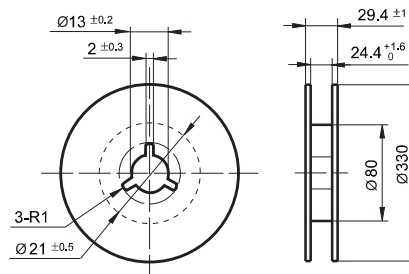

Tape Dimensions (S type: Standard SMT)

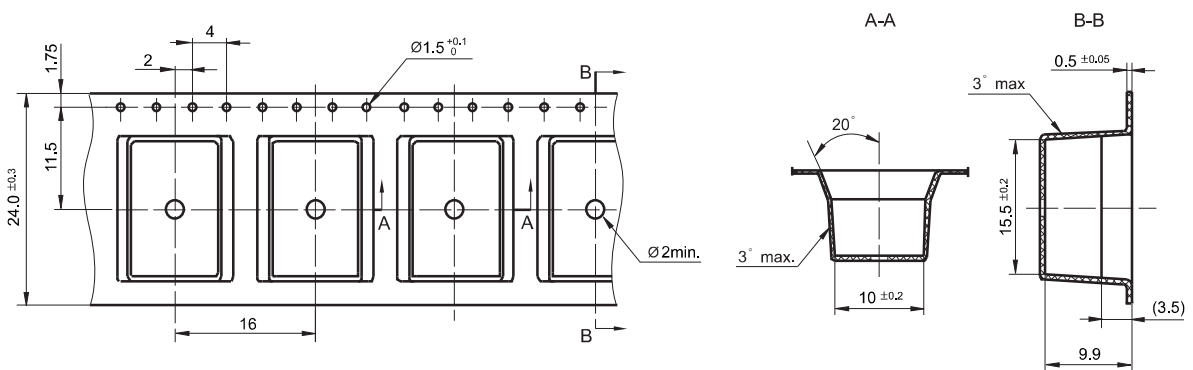

Tape Dimensions (S1 type: Short terminal SMT)

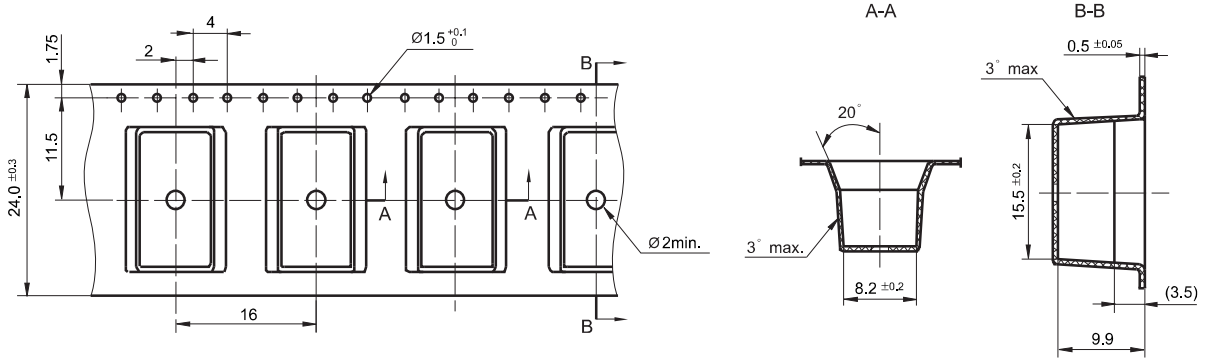

- Remark: 1) In case of no tolerance shown in outline dimension: outline dimension ≤ 1 mm, tolerance should be ± 0.2 mm; outline dimension > 1 mm and ≤ 5 mm, tolerance should be ± 0.3 mm; outline dimension > 5 mm, tolerance should be ± 0.4 mm.
 2) The tolerance without indicating for PCB layout is always ± 0.1 mm.
 3) The width of the gridding is 2.54mm.

CHARACTERISTIC CURVES

MAXIMUM SWITCHING POWER

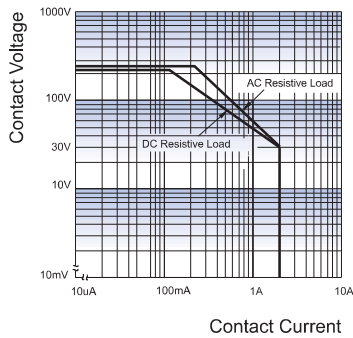

ENDURANCE CURVE

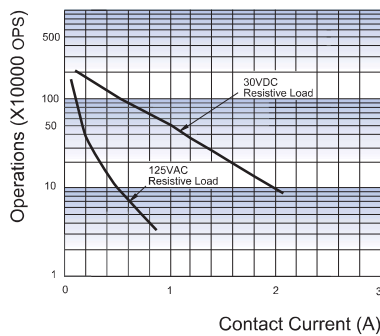

REFLOW WELDING, TEMPERATURE ON PCB BOARD
RECOMMENDED WELDING TEMPERATURE

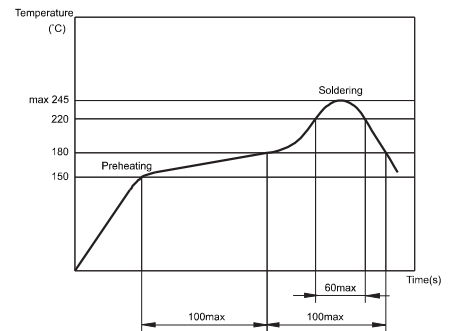

Notice

- 1) This relay is highly sensitive polarized relay, if correct polarity is not applied to the coil terminals, the relay does not operate properly.
- 2) To avoid using relays under strong magnetic field which will change the parameters of relays such as pick-up voltage and drop-out voltage.
- 3) Relay is on the "reset" status when being released from stock, with the consideration of shock risen from transit and relay mounting, it should be changed to the "set" status when application(connecting to the power supply). Please reset the relay to "set" or "reset" status on request.
- 4) In order to maintain the "set" or "reset" status, energized voltage to coil should reach the rated voltage, impulse width should be more than 5 times of "set" or "reset" time.
- 5) For 2 coil latching relay, do not energize voltage to "set" coil and "reset" coil simultaneously.
- 6) The relay may be damaged because of falling or when shocking conditions exceed the requirement.
- 7) Regarding the plastic sealed relay, we should leave it cooling naturally until below 40°C after welding, then clean it and deal with coating, remarkably the temperature of solvents should also be controlled below 40°C. Please avoid cleaning the relay by ultrasonic, avoid using the solvents like gasoline, Freon, and so on, which would affect the configuration of relay or influence the environment.
- 8) About preferable condition of operation, storage and transportation, please refer to "Explanation to terminology and guidelines of relay".

Disclaimer

This datasheet is for the customers' reference. All the specifications are subject to change without notice. We could not evaluate all the performance and all the parameters for every possible application. Thus the user should be in a right position to choose the suitable product for their own application. If there is any query, please contact Hongfa for the technical service. However, it is the user's responsibility to determine which product should be used only.