

AUTOMOTIVE MOSFET **IRFP2907PbF**
HEXFET® Power MOSFET

Typical Applications

- Integrated Starter Alternator
- 42 Volts Automotive Electrical Systems
- Lead-Free

Benefits

- Advanced Process Technology
- Ultra Low On-Resistance
- Dynamic dv/dt Rating
- 175°C Operating Temperature
- Fast Switching
- Repetitive Avalanche Allowed up to Tjmax

Description

Specifically designed for Automotive applications, this Stripe Planar design of HEXFET® Power MOSFETs utilizes the latest processing techniques to achieve extremely low on-resistance per silicon area. Additional features of this HEXFET power MOSFET are a 175°C junction operating temperature, fast switching speed and improved repetitive avalanche rating. These benefits combine to make this design an extremely efficient and reliable device for use in Automotive applications and a wide variety of other applications.

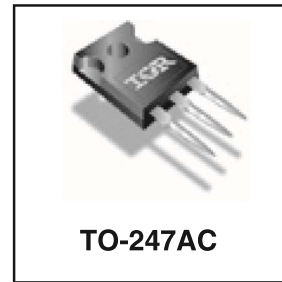
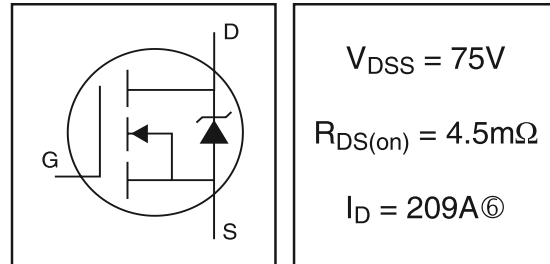

Absolute Maximum Ratings

| | Parameter | Max. | Units |
|---|--|--------------------------|-------|
| I _D @ T _C = 25°C | Continuous Drain Current, V _{GS} @ 10V | 209 [Ⓔ] | A |
| I _D @ T _C = 100°C | Continuous Drain Current, V _{GS} @ 10V | 148 [Ⓔ] | |
| I _{DM} | Pulsed Drain Current [Ⓛ] | 840 | |
| P _D @ T _C = 25°C | Power Dissipation | 470 | W |
| | Linear Derating Factor | 3.1 | W/°C |
| V _{GS} | Gate-to-Source Voltage | ± 20 | V |
| E _{AS} | Single Pulse Avalanche Energy [Ⓜ] | 1970 | mJ |
| I _{AR} | Avalanche Current | See Fig.12a, 12b, 15, 16 | A |
| E _{AR} | Repetitive Avalanche Energy [Ⓜ] | | mJ |
| dv/dt | Peak Diode Recovery dv/dt [Ⓢ] | 5.0 | V/ns |
| T _J | Operating Junction and Storage Temperature Range | -55 to + 175 | °C |
| T _{STG} | | | |
| | | | |
| | Mounting Torque, 6-32 or M3 screw | 10 lbf•in (1.1N•m) | |

Thermal Resistance

| | Parameter | Typ. | Max. | Units |
|------------------|-------------------------------------|------|------|-------|
| R _{θJC} | Junction-to-Case | — | 0.32 | °C/W |
| R _{θCS} | Case-to-Sink, Flat, Greased Surface | 0.24 | — | |
| R _{θJA} | Junction-to-Ambient | — | 40 | |

IRFP2907PbF

International
IR Rectifier

Electrical Characteristics @ $T_J = 25^\circ\text{C}$ (unless otherwise specified)

| | Parameter | Min. | Typ. | Max. | Units | Conditions |
|---------------------------------|--------------------------------------|------|-------|------|---------------------|---|
| $V_{(BR)DSS}$ | Drain-to-Source Breakdown Voltage | 75 | — | — | V | $V_{GS} = 0V, I_D = 250\mu A$ |
| $\Delta V_{(BR)DSS}/\Delta T_J$ | Breakdown Voltage Temp. Coefficient | — | 0.085 | — | V/ $^\circ\text{C}$ | Reference to $25^\circ\text{C}, I_D = 1\text{mA}$ |
| $R_{DS(on)}$ | Static Drain-to-Source On-Resistance | — | 3.6 | 4.5 | m Ω | $V_{GS} = 10V, I_D = 125A$ ④ |
| $V_{GS(th)}$ | Gate Threshold Voltage | 2.0 | — | 4.0 | V | $V_{DS} = 10V, I_D = 250\mu A$ |
| g_{fs} | Forward Transconductance | 130 | — | — | S | $V_{DS} = 25V, I_D = 125A$ |
| I_{DSS} | Drain-to-Source Leakage Current | — | — | 20 | μA | $V_{DS} = 75V, V_{GS} = 0V$ $V_{DS} = 60V, V_{GS} = 0V, T_J = 150^\circ\text{C}$ |
| I_{GSS} | Gate-to-Source Forward Leakage | — | — | 200 | nA | $V_{GS} = 20V$ |
| | Gate-to-Source Reverse Leakage | — | — | -200 | nA | $V_{GS} = -20V$ |
| Q_g | Total Gate Charge | — | 410 | 620 | nC | $I_D = 125A$ |
| Q_{gs} | Gate-to-Source Charge | — | 92 | 140 | nC | $V_{DS} = 60V$ |
| Q_{gd} | Gate-to-Drain ("Miller") Charge | — | 140 | 210 | nC | $V_{GS} = 10V$ ④ |
| $t_{d(on)}$ | Turn-On Delay Time | — | 23 | — | ns | $V_{DD} = 38V$ |
| t_r | Rise Time | — | 190 | — | ns | $I_D = 125A$ |
| $t_{d(off)}$ | Turn-Off Delay Time | — | 130 | — | ns | $R_G = 1.2\Omega$ |
| t_f | Fall Time | — | 130 | — | ns | $V_{GS} = 10V$ ④ |
| L_D | Internal Drain Inductance | — | 5.0 | — | nH | Between lead, 6mm (0.25in.) from package and center of die contact |
| L_S | Internal Source Inductance | — | 13 | — | nH | |
| C_{iss} | Input Capacitance | — | 13000 | — | pF | $V_{GS} = 0V$ |
| C_{oss} | Output Capacitance | — | 2100 | — | pF | $V_{DS} = 25V$ |
| C_{rss} | Reverse Transfer Capacitance | — | 500 | — | pF | $f = 1.0\text{MHz}$, See Fig. 5 |
| C_{oss} | Output Capacitance | — | 9780 | — | pF | $V_{GS} = 0V, V_{DS} = 1.0V, f = 1.0\text{MHz}$ |
| C_{oss} | Output Capacitance | — | 1360 | — | pF | $V_{GS} = 0V, V_{DS} = 60V, f = 1.0\text{MHz}$ |
| $C_{oss\ eff.}$ | Effective Output Capacitance ⑤ | — | 2320 | — | pF | $V_{GS} = 0V, V_{DS} = 0V \text{ to } 60V$ |

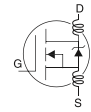

Source-Drain Ratings and Characteristics

| | Parameter | Min. | Typ. | Max. | Units | Conditions |
|----------|--|---|------|------|-------|--|
| I_S | Continuous Source Current (Body Diode) | — | — | 209 | A | MOSFET symbol showing the integral reverse p-n junction diode. |
| I_{SM} | Pulsed Source Current (Body Diode) ① | — | — | 840 | A | |
| V_{SD} | Diode Forward Voltage | — | — | 1.3 | V | $T_J = 25^\circ\text{C}, I_S = 125A, V_{GS} = 0V$ ④ |
| t_{rr} | Reverse Recovery Time | — | 140 | 210 | ns | $T_J = 25^\circ\text{C}, I_F = 125A$ |
| Q_{rr} | Reverse Recovery Charge | — | 880 | 1320 | nC | $di/dt = 100A/\mu s$ ④ |
| t_{on} | Forward Turn-On Time | Intrinsic turn-on time is negligible (turn-on is dominated by L_S+L_D) | | | | |

Notes:

- ① Repetitive rating; pulse width limited by max. junction temperature. (See fig. 11).
- ② Starting $T_J = 25^\circ\text{C}$, $L = 0.25\text{mH}$, $R_G = 25\Omega$, $I_{AS} = 125A$. (See Figure 12).
- ③ $I_{SD} \leq 125A$, $di/dt \leq 260A/\mu s$, $V_{DD} \leq V_{(BR)DSS}$, $T_J \leq 175^\circ\text{C}$
- ④ Pulse width $\leq 400\mu s$; duty cycle $\leq 2\%$.
- ⑤ $C_{oss\ eff.}$ is a fixed capacitance that gives the same charging time as C_{oss} while V_{DS} is rising from 0 to 80% V_{DSS} .
- ⑥ Calculated continuous current based on maximum allowable junction temperature. Package limitation current is 90A.
- ⑦ Limited by T_{Jmax} , see Fig.12a, 12b, 15, 16 for typical repetitive avalanche performance.

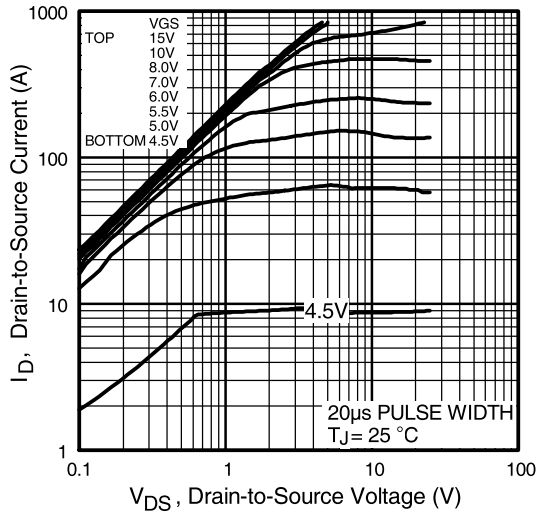

Fig 1. Typical Output Characteristics

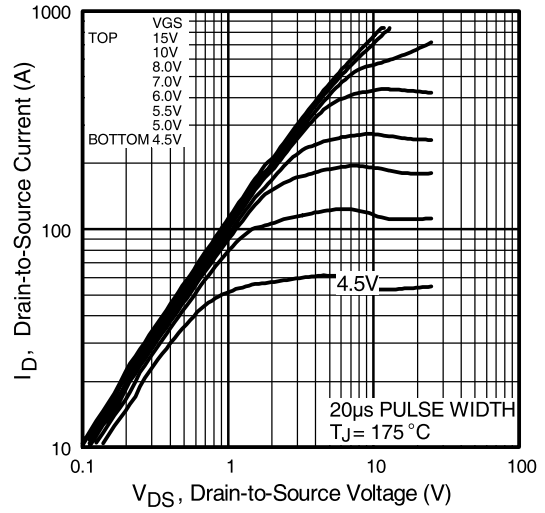

Fig 2. Typical Output Characteristics

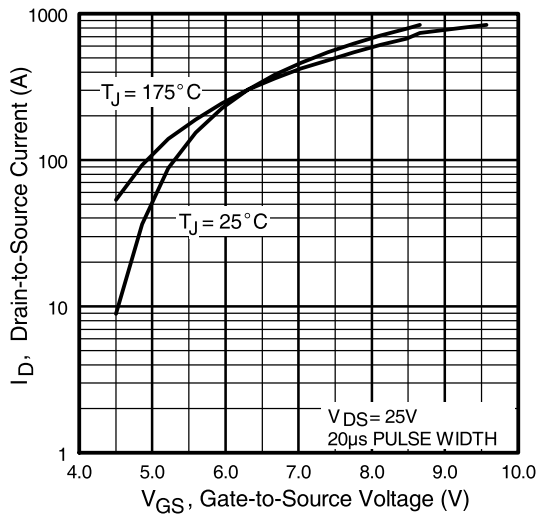

Fig 3. Typical Transfer Characteristics

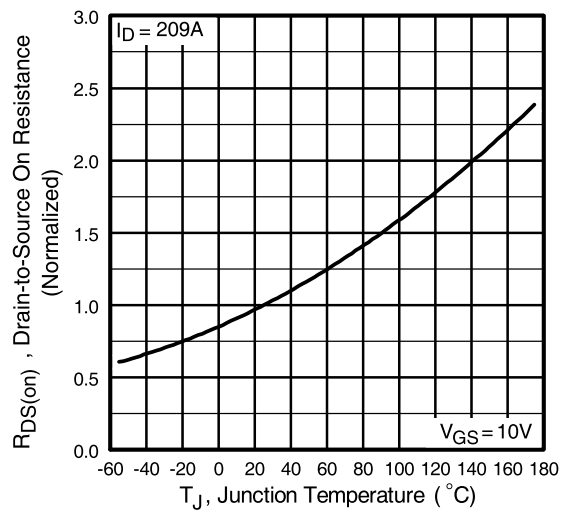

Fig 4. Normalized On-Resistance Vs. Temperature

IRFP2907PbF

International
IR Rectifier

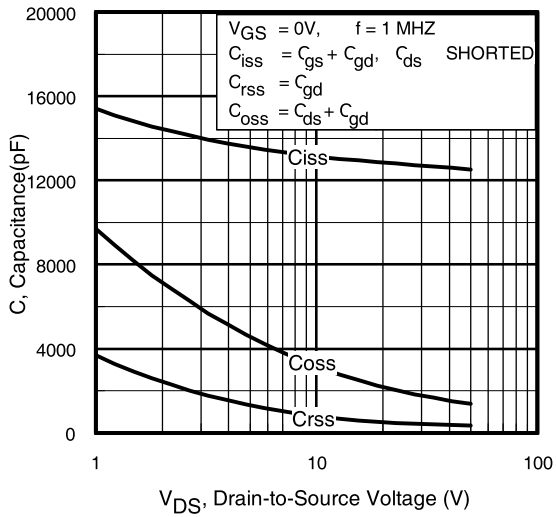

Fig 5. Typical Capacitance Vs. Drain-to-Source Voltage

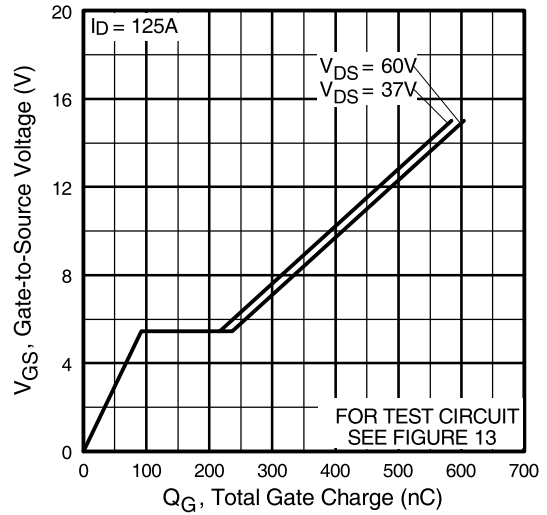

Fig 6. Typical Gate Charge Vs. Gate-to-Source Voltage

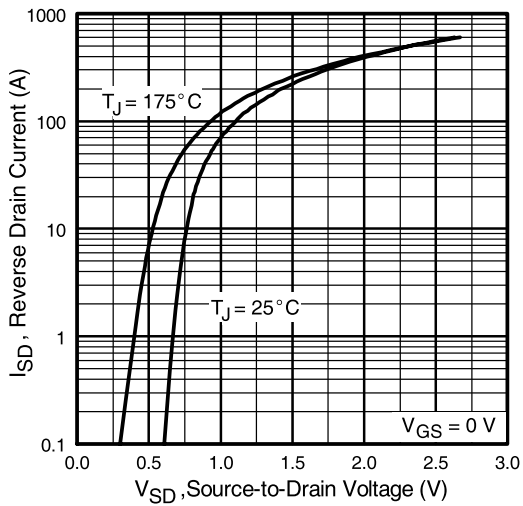

Fig 7. Typical Source-Drain Diode Forward Voltage

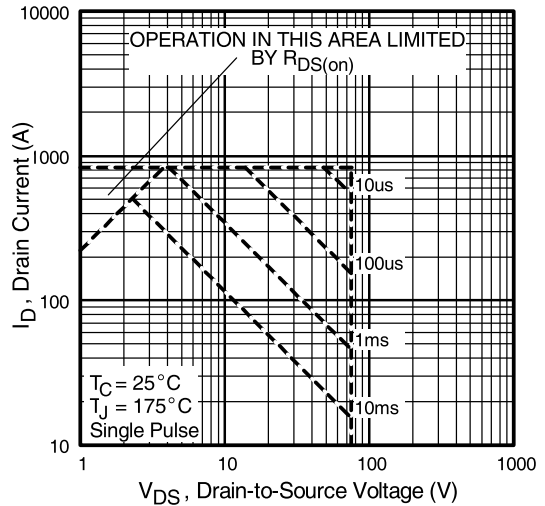

Fig 8. Maximum Safe Operating Area

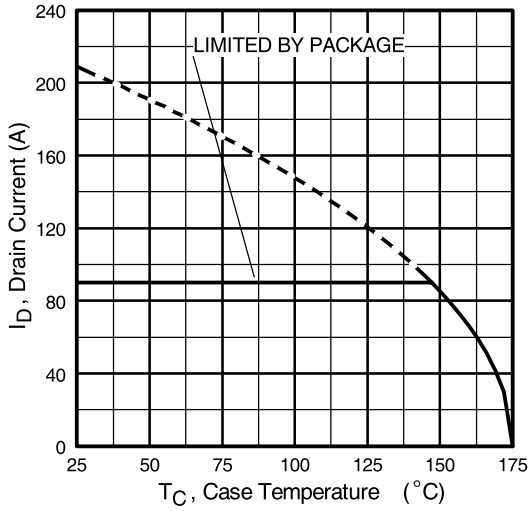

Fig 9. Maximum Drain Current Vs. Case Temperature

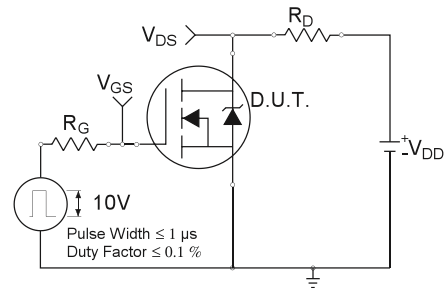

Fig 10a. Switching Time Test Circuit

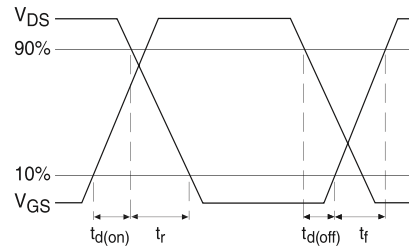

Fig 10b. Switching Time Waveforms

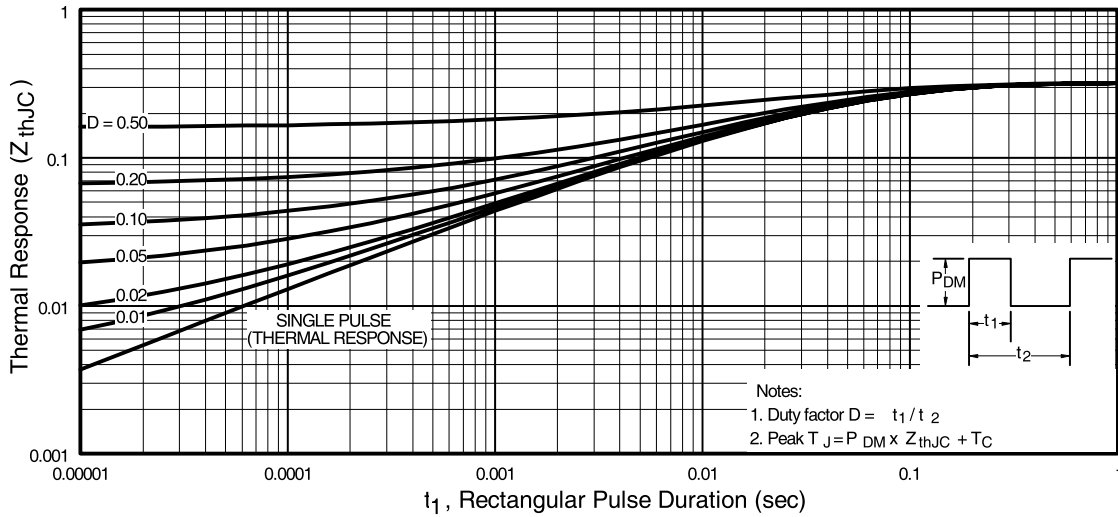

Fig 11. Maximum Effective Transient Thermal Impedance, Junction-to-Case

IRFP2907PbF

International
IR Rectifier

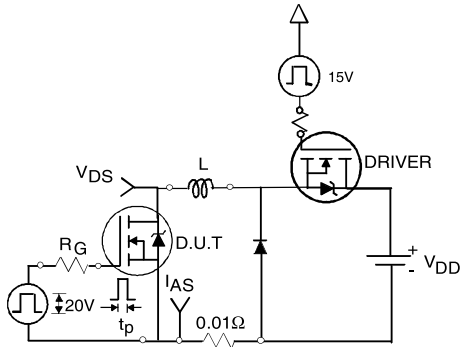

Fig 12a. Unclamped Inductive Test Circuit

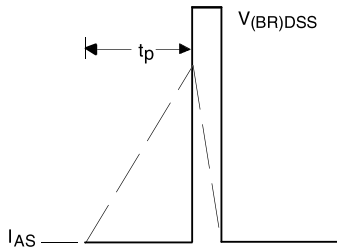

Fig 12b. Unclamped Inductive Waveforms

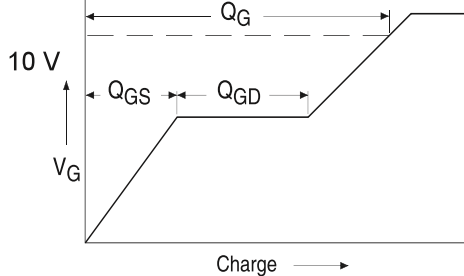

Fig 13a. Basic Gate Charge Waveform

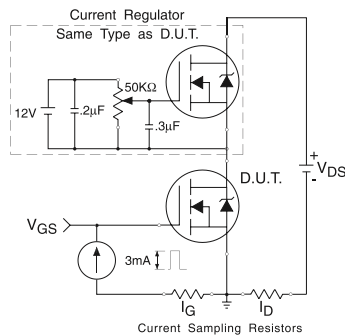

Fig 13b. Gate Charge Test Circuit

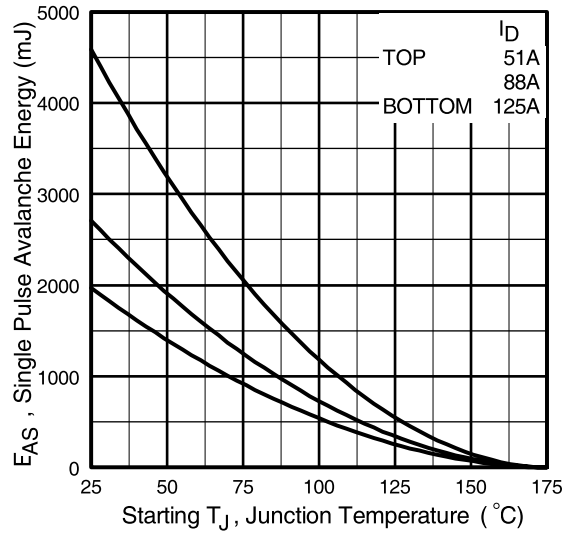

Fig 12c. Maximum Avalanche Energy Vs. Drain Current

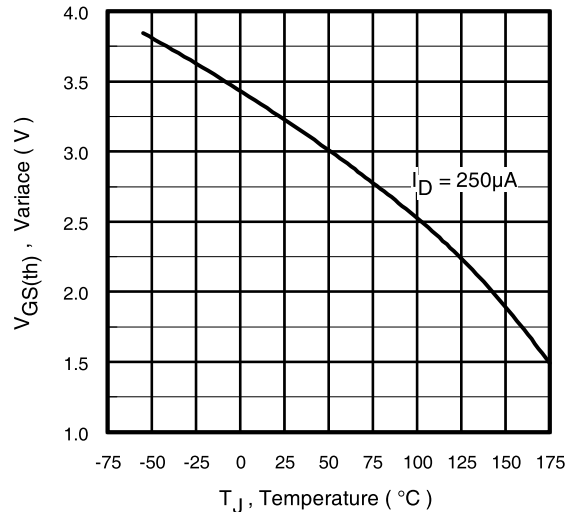

Fig 14. Threshold Voltage Vs. Temperature

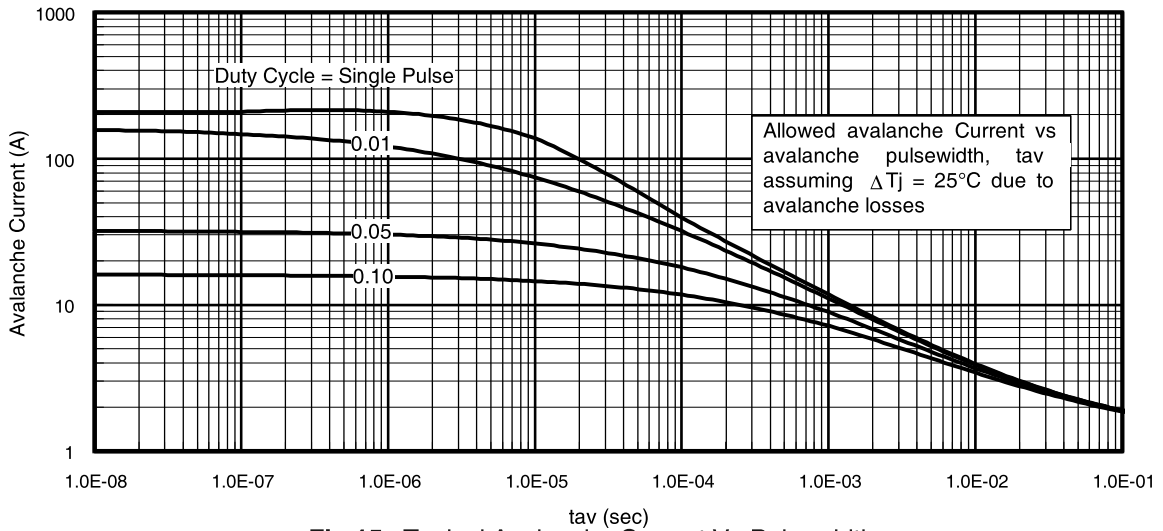

Fig 15. Typical Avalanche Current Vs.Pulsewidth

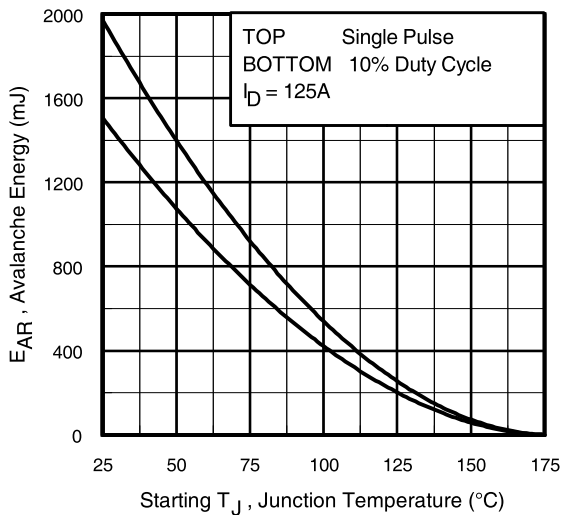

Fig 16. Maximum Avalanche Energy Vs. Temperature

Notes on Repetitive Avalanche Curves , Figures 15, 16:
(For further info, see AN-1005 at www.irf.com)

1. Avalanche failures assumption:
Purely a thermal phenomenon and failure occurs at a temperature far in excess of T_{jmax} . This is validated for every part type.
2. Safe operation in Avalanche is allowed as long as ΔT_{jmax} is not exceeded.
3. Equation below based on circuit and waveforms shown in Figures 12a, 12b.
4. $P_{D(ave)}$ = Average power dissipation per single avalanche pulse.
5. BV = Rated breakdown voltage (1.3 factor accounts for voltage increase during avalanche).
6. I_{av} = Allowable avalanche current.
7. ΔT = Allowable rise in junction temperature, not to exceed T_{jmax} (assumed as 25°C in Figure 15, 16).
 t_{av} = Average time in avalanche.
 D = Duty cycle in avalanche = $t_{av} \cdot f$
 $Z_{thJC}(D, t_{av})$ = Transient thermal resistance, see figure 11)

$$P_{D(ave)} = 1/2 (1.3 \cdot BV \cdot I_{av}) = \Delta T / Z_{thJC}$$

$$I_{av} = 2 \Delta T / [1.3 \cdot BV \cdot Z_{th}]$$

$$E_{AS(AR)} = P_{D(ave)} \cdot t_{av}$$

Peak Diode Recovery dv/dt Test Circuit

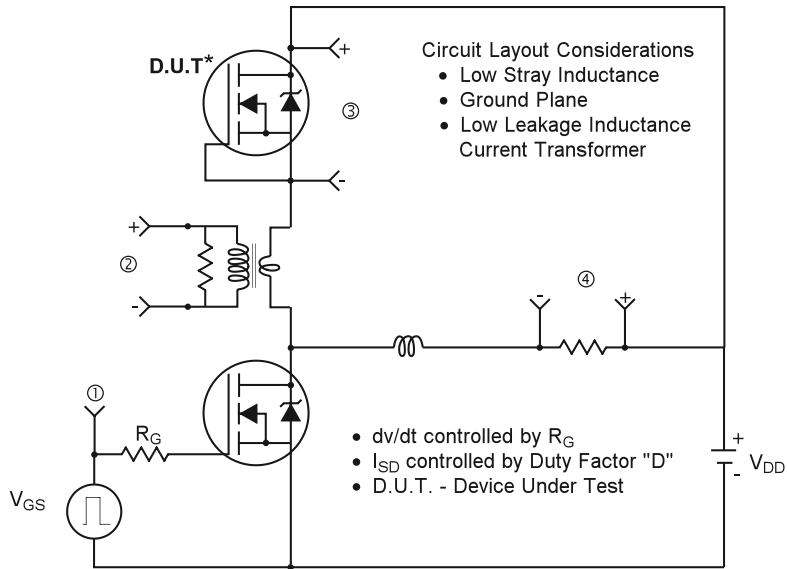

* Reverse Polarity of D.U.T for P-Channel

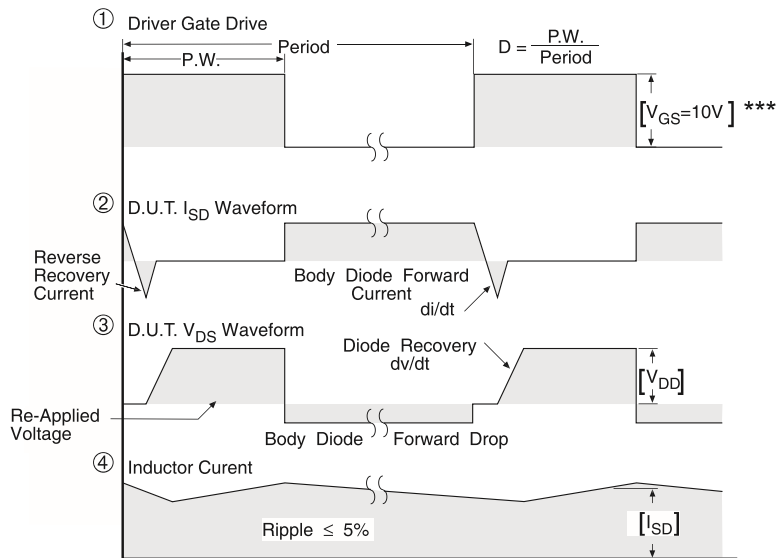

*** $V_{GS} = 5.0V$ for Logic Level and 3V Drive Devices

Fig 17. For N-channel HEXFET® power MOSFETs

TO-247AC Package Outline

Dimensions are shown in millimeters (inches)

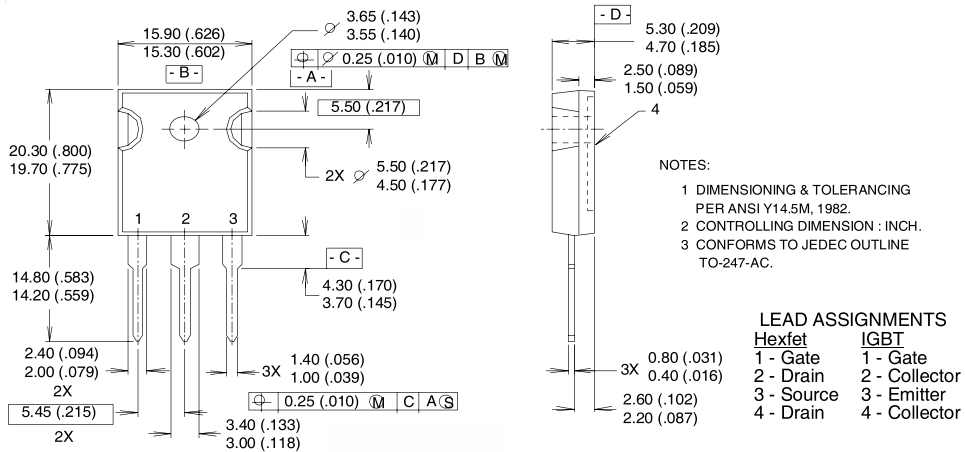

TO-247AC Part Marking Information

EXAMPLE: THIS IS AN IRFP30
 WITH ASSEMBLY
 LOT CODE 5657
 ASSEMBLED ON WW 35, 2000
 IN THE ASSEMBLY LINE "H"

Note: "P" in assembly line position indicates "Lead-Free"

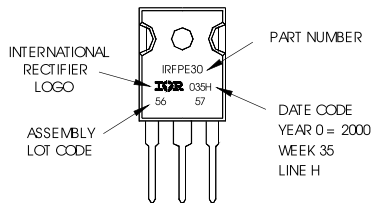

Data and specifications subject to change without notice.

Note: For the most current drawings please refer to the IR website at:
<http://www.irf.com/package/>