

SM72375 SolarMagic Dual Micropower Rail-To-Rail Input CMOS Comparator with Open Drain Output

Check for Samples: [SM72375](#)

FEATURES

- **Renewable Energy Grade**
(Typical Unless Otherwise Noted)
- **Low Power Consumption (Max):** $I_S = 10 \mu\text{A}/\text{comp}$
- **Wide Range of Supply Voltages:** 2.7V to 15V
- **Rail-to-Rail Input Common Mode Voltage Range**
- **Open Drain Output**
- **Short Circuit Protection:** 40 mA
- **Propagation Delay (@ $V_S = 5\text{V}$, 100 mV Overdrive):** 5 μs
- **-40°C to 125°C Temperature Range**

APPLICATIONS

- **Metering Systems**
- **RC Timers**
- **Alarm and Monitoring Circuits**
- **Window Comparators, Multivibrators**

Connection Diagram

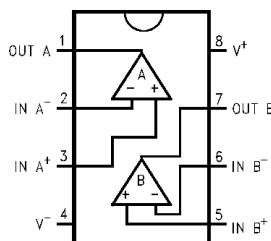

**Figure 1. 8-Pin VSSOP - Top View
Package Number DGK**



These devices have limited built-in ESD protection. The leads should be shorted together or the device placed in conductive foam during storage or handling to prevent electrostatic damage to the MOS gates.



Please be aware that an important notice concerning availability, standard warranty, and use in critical applications of Texas Instruments semiconductor products and disclaimers thereto appears at the end of this data sheet.

All trademarks are the property of their respective owners.

Absolute Maximum Ratings⁽¹⁾⁽²⁾

ESD Tolerance ⁽³⁾	1.5 kV
Differential Input Voltage	(V ⁺)+0.3V to (V ⁻)-0.3V
Voltage at Input/Output Pin	(V ⁺)+0.3V to (V ⁻)-0.3V
Supply Voltage (V ⁺ -V ⁻)	16V
Current at Input Pin ⁽⁴⁾	±5 mA
Current at Output Pin ⁽⁵⁾⁽⁶⁾	±30 mA
Current at Power Supply Pin, SM72375	40 mA
Lead Temperature (Soldering, 10 seconds)	260°C
Storage Temperature Range	-65°C to +150°C
Junction Temperature ⁽⁷⁾	150°C

- (1) Absolute Maximum Ratings indicate limits beyond which damage to the device may occur. Operating Ratings indicate conditions for which the device is intended to be functional, but specific performance is not ensured. For ensured specifications and the test conditions, see the electrical characteristics.
- (2) If Military/Aerospace specified devices are required, please contact the Texas Instruments Sales Office/ Distributors for availability and specifications.
- (3) Human body model, 1.5 kΩ in series with 100 pF. The output pins of the two comparators (pin 1 and pin 7) have an ESD tolerance of 1.5 kV. All other pins have an ESD tolerance of 2 kV.
- (4) Limiting input pin current is only necessary for input voltages that exceed absolute maximum input voltage ratings.
- (5) Applies to both single-supply and split-supply operation. Continuous short circuit operation at elevated ambient temperature can result in exceeding the maximum allowed junction temperature of 150°C. Output currents in excess of ±30 mA over long term may adversely affect reliability.
- (6) Do not short circuit output to V⁺, when V⁺ is > 12V or reliability will be adversely affected.
- (7) The maximum power dissipation is a function of T_{J(max)}, θ_{JA}, and T_A. The maximum allowable power dissipation at any ambient temperature is P_D = (T_{J(max)} - T_A)/θ_{JA}. All numbers apply for packages soldered directly into a PC board.

Operating Ratings⁽¹⁾

Supply Voltage	2.7 ≤ V _S ≤ 15V
Temperature Range	- 40°C ≤ T _A ≤ +125°C
Thermal Resistance (θ _{JA})	8-Pin VSSOP 172°C/W

- (1) Absolute Maximum Ratings indicate limits beyond which damage to the device may occur. Operating Ratings indicate conditions for which the device is intended to be functional, but specific performance is not ensured. For ensured specifications and the test conditions, see the electrical characteristics.

2.7V Electrical Characteristics

Unless otherwise specified, all limits ensured for T_A = 25°C, V⁺ = 2.7V, V⁻ = 0V, V_{CM} = V⁺/2. **Boldface** limits apply at the temperature extremes.

Symbol	Parameter	Conditions	Min ⁽¹⁾	Typ ⁽²⁾	Max ⁽¹⁾	Units
V _{OS}	Input Offset Voltage			3	10 13	mV
TCV _{OS}	Input Offset Voltage Temperature Drift			2.0		μV/Month
	Input Offset Voltage Average Drift	See ⁽³⁾		3.3		
I _B	Input Current			0.02		pA
I _{OS}	Input Offset Current			0.01		pA
CMRR	Common Mode Rejection Ratio			75		dB
PSRR	Power Supply Rejection Ratio	±1.35V < V _S < ±7.5V		80		dB
A _V	Voltage Gain	(By Design)		100		dB
V _{CM}	Input Common-Mode Voltage Range	CMRR > 55 dB	2.9 2.7	3.0		V
				-0.3	-0.2 0.0	

- (1) All limits are ensured by testing or statistical analysis.
- (2) Typical Values represent the most likely parametric norm.
- (3) Input offset voltage Average Drift is calculated by dividing the accelerated operating life drift average by the equivalent operational time. The input offset voltage average drift represents the input offset voltage change at worst-case input conditions.

2.7V Electrical Characteristics (continued)

Unless otherwise specified, all limits ensured for $T_A = 25^\circ\text{C}$, $V^+ = 2.7\text{V}$, $V^- = 0\text{V}$, $V_{\text{CM}} = V^+/2$. **Boldface** limits apply at the temperature extremes.

Symbol	Parameter	Conditions	Min ⁽¹⁾	Typ ⁽²⁾	Max ⁽¹⁾	Units
V_{OL}	Output Voltage Low	$I_{\text{LOAD}} = 2.5\text{ mA}$		0.2	0.3 0.45	V
I_{S}	Supply Current	For Both Comparators		12	20 25	μA
I_{Leakage}	Output Leakage Current	$V_{\text{IN}(+)} = 0.5\text{V}$, $V_{\text{IN}(-)} = 0\text{V}$, $V_{\text{O}} = 15\text{V}$	500	0.1		nA

5.0V and 15.0V Electrical Characteristics

Unless otherwise specified, all limits ensured for $T_A = 25^\circ\text{C}$, $V^+ = 5.0\text{V}$ and 15.0V , $V^- = 0\text{V}$, $V_{\text{CM}} = V^+/2$. **Boldface** limits apply at the temperature extremes.

Symbol	Parameter	Conditions	Min ⁽¹⁾	Typ ⁽²⁾	Max ⁽¹⁾	Units
V_{OS}	Input Offset Voltage			3	10 13	mV
TCV_{OS}	Input Offset Voltage Temperature Drift	$V^+ = 5\text{V}$		2.0		$\mu\text{V}/^\circ\text{C}$
		$V^+ = 15\text{V}$		0.4		
	Input Offset Voltage Average Drift	$V^+ = 5\text{V}^{(3)}$		3.3		$\mu\text{V}/\text{Month}$
		$V^+ = 15\text{V}^{(3)}$		4.0		
I_{B}	Input Current	$V = 5\text{V}$		0.04		μA
I_{OS}	Input Offset Current	$V^+ = 5\text{V}$		0.02		μA
CMRR	Common Mode Rejection Ratio	$V^+ = 5\text{V}$		75		dB
		$V^+ = 15\text{V}$		82		
PSRR	Power Supply Rejection Ratio	$\pm 2.5\text{V} < V_{\text{S}} < \pm 5\text{V}$		80		dB
A_{V}	Voltage Gain	(By Design)		100		dB
V_{CM}	Input Common-Mode Voltage Range	$V^+ = 5.0\text{V}$ CMRR > 55 dB	5.2 5.0	5.3		V
				-0.3	-0.2 0.0	
		$V^+ = 15.0\text{V}$ CMRR > 55 dB	15.2 15.0	15.3		
				-0.3	-0.2 0.0	
V_{OL}	Output Voltage Low	$V^+ = 5\text{V}$ $I_{\text{LOAD}} = 5\text{ mA}$		0.2	0.4 0.55	V
		$V^+ = 15\text{V}$ $I_{\text{LOAD}} = 5\text{ mA}$		0.2	0.4 0.55	
I_{S}	Supply Current	For Both Comparators (Output Low)		12	20 25	μA
I_{SC}	Short Circuit Current	$V^+ = 15\text{V}$, Sinking, $V_{\text{O}} = 12\text{V}^{(4)}$	45			mA

(1) All limits are ensured by testing or statistical analysis.

(2) Typical Values represent the most likely parametric norm.

(3) Input offset voltage Average Drift is calculated by dividing the accelerated operating life drift average by the equivalent operational time. The input offset voltage average drift represents the input offset voltage change at worst-case input conditions.

(4) Do not short circuit output to V^+ , when V^+ is > 12V or reliability will be adversely affected.

AC Electrical Characteristics

Unless otherwise specified, all limits ensured for $T_A = 25^\circ\text{C}$, $V^+ = 5\text{V}$, $V^- = 0\text{V}$, $V_{\text{CM}} = V_O = V^+/2$. **Boldface** limits apply at the temperature extreme.

Symbol	Parameter	Conditions	Min ⁽¹⁾	Typ ⁽²⁾	Max ⁽¹⁾	Units
t_{RISE}	Rise Time	$f = 10\text{ kHz}$, $C_L = 50\text{ pF}$, Overdrive = 10 mV ⁽³⁾		0.3		μs
t_{FALL}	Fall Time	$f = 10\text{ kHz}$, $C_L = 50\text{ pF}$, ⁽³⁾		0.3		μs
t_{PHL}	Propagation Delay (High to Low)	$f = 10\text{ kHz}$, $C_L = 50\text{ pF}$ ⁽³⁾	10 mV	10		μs
			100 mV	4		
		$V^+ = 2.7\text{V}$, $f = 10\text{ kHz}$, $C_L = 50\text{ pF}$ ⁽³⁾	10 mV	10		μs
			100 mV	4		
t_{PLH}	Propagation Delay (Low to High)	$f = 10\text{ kHz}$, $C_L = 50\text{ pF}$ ⁽³⁾	10 mV	10		μs
			100 mV	4		
		$V^+ = 2.7\text{V}$, $f = 10\text{ kHz}$, $C_L = 50\text{ pF}$ ⁽³⁾	10 mV	8		μs
			100 mV	4		

(1) All limits are ensured by testing or statistical analysis.

(2) Typical Values represent the most likely parametric norm.

(3) C_L includes the probe and jig capacitance. The rise time, fall time and propagation delays are measured with a 2V input step.

Typical Performance Characteristics

$V^+ = 5V$, Single Supply, $T_A = 25^\circ C$ unless otherwise specified

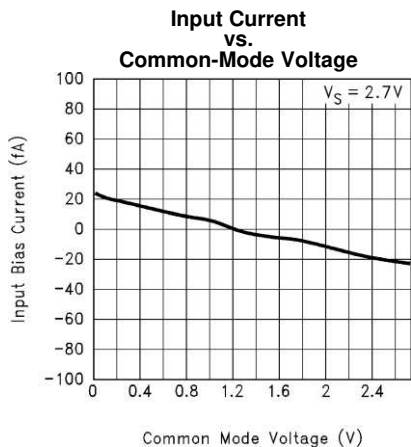

Figure 2.

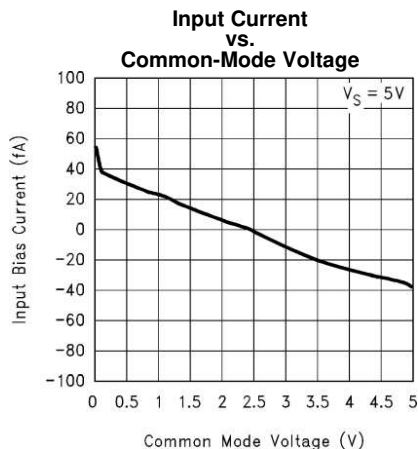

Figure 3.

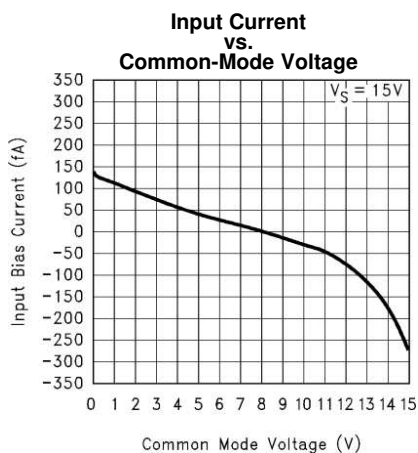

Figure 4.

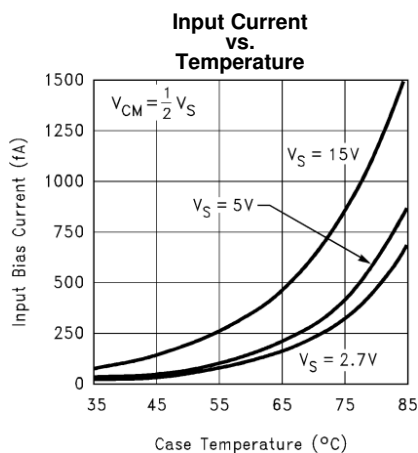

Figure 5.

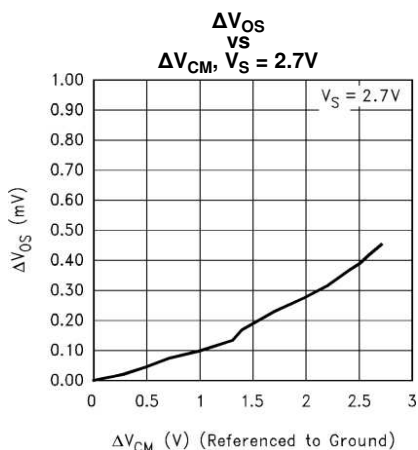

Figure 6.

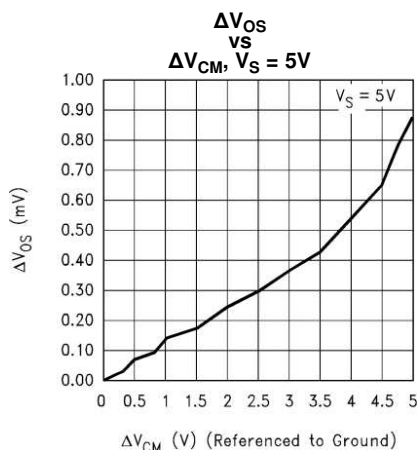
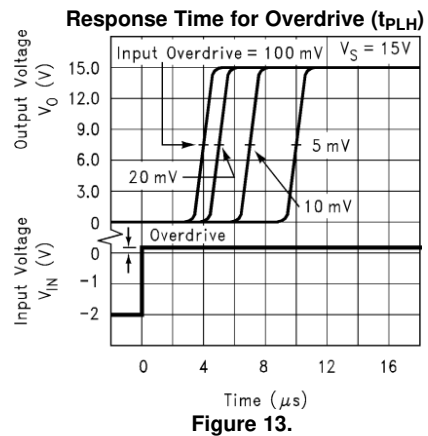
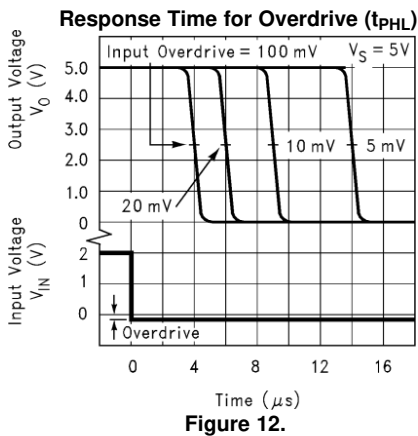
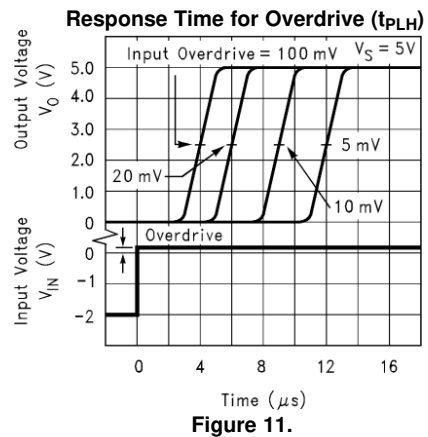
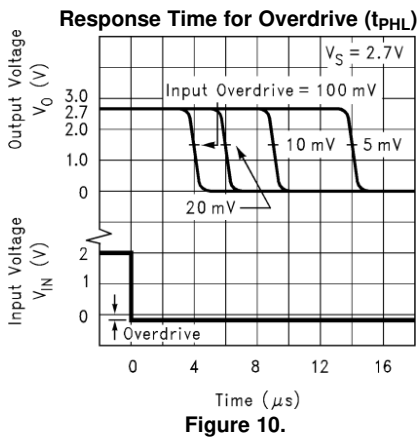
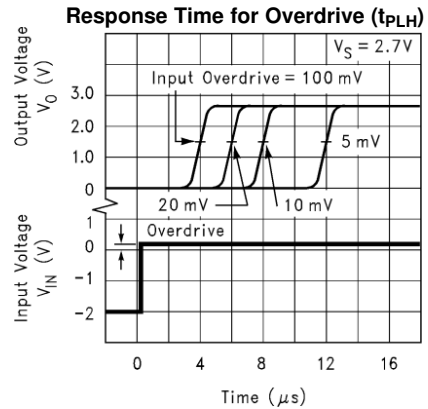
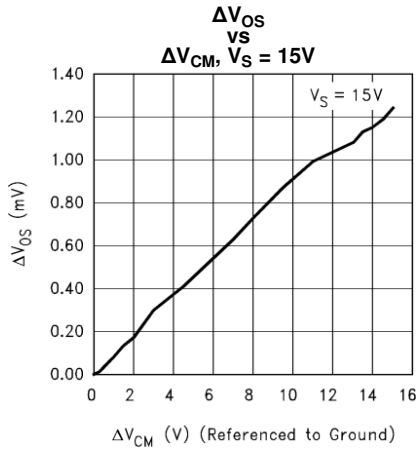

Figure 7.

Typical Performance Characteristics (continued)

V⁺ = 5V, Single Supply, T_A = 25°C unless otherwise specified



Typical Performance Characteristics (continued)

V⁺ = 5V, Single Supply, T_A = 25°C unless otherwise specified

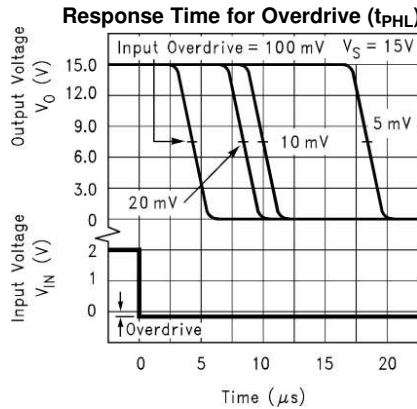

Figure 14.

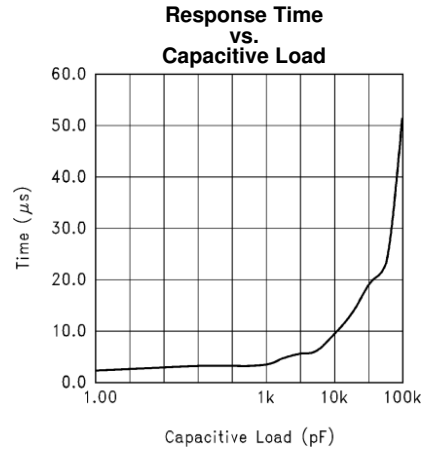

Figure 15.

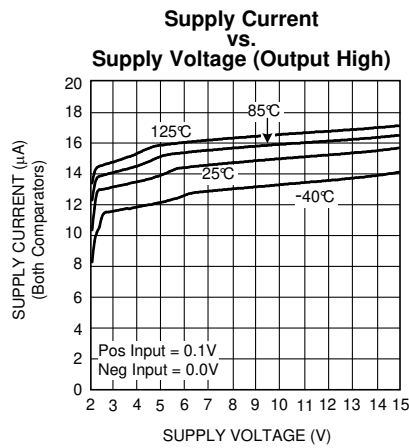

Figure 16.

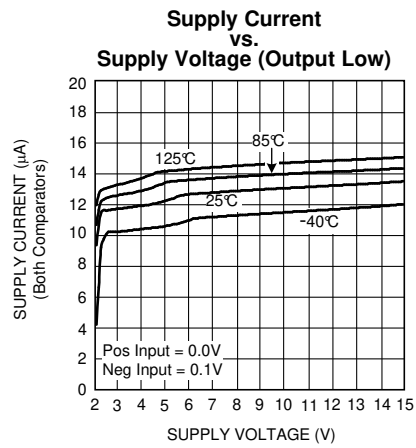

Figure 17.

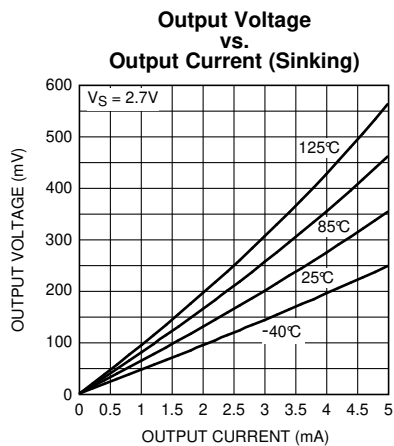

Figure 18.

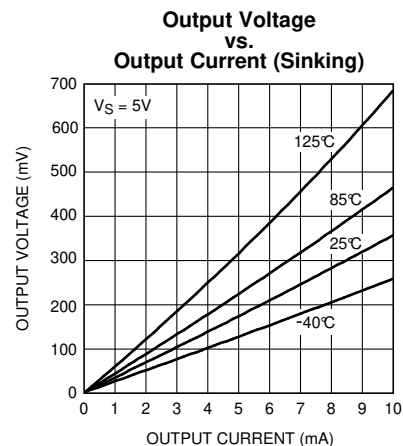

Figure 19.

Typical Performance Characteristics (continued)

V⁺ = 5V, Single Supply, T_A = 25°C unless otherwise specified

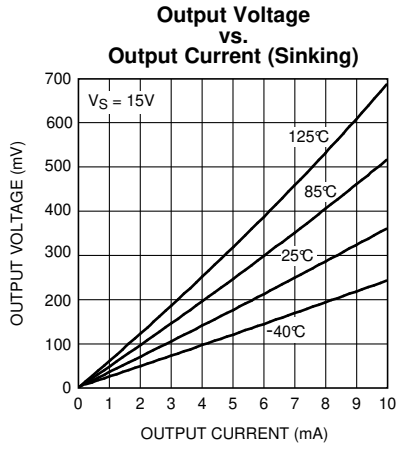

Figure 20.

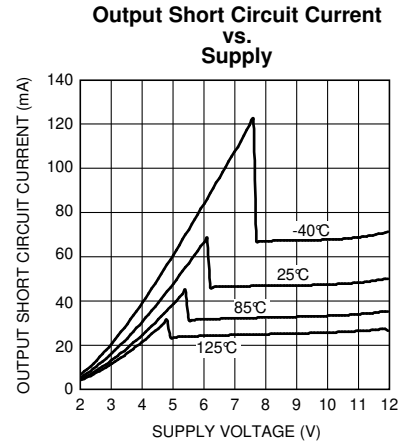

Figure 21.

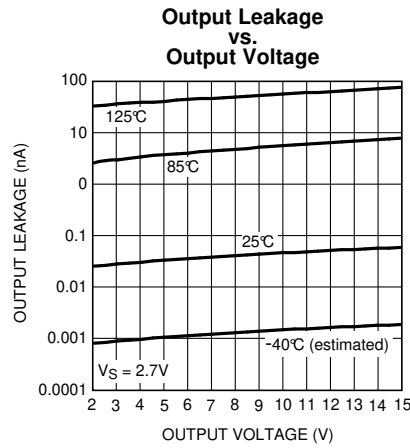

Figure 22.

APPLICATION INFORMATION

1.0 INPUT COMMON-MODE VOLTAGE RANGE

At supply voltages of 2.7V, 5V and 15V, the SM72375 has an input common-mode voltage range (CMVR) which exceeds both supplies. As in the case of operational amplifiers, CMVR is defined by the V_{OS} shift of the comparator over the common-mode range of the device. A common-mode rejection ratio (CMRR, defined as $\Delta V_{OS}/\Delta V_{CM}$) of 75 dB (typical) implies a shift of < 1 mV over the entire common-mode range of the device. The absolute maximum input voltage at $V^+ = 5V$ is 200 mV beyond either supply rail at room temperature.

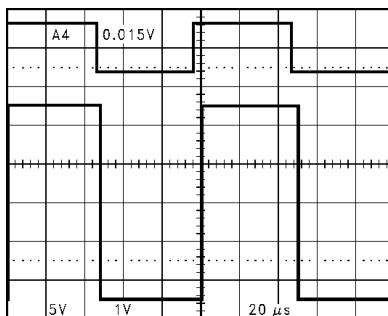

Figure 23. An Input Signal Exceeds the SM72375 Power Supply Voltages with No Output Phase Inversion

A wide input voltage range means that the comparator can be used to sense signals close to ground and also to the power supplies. This is an extremely useful feature in power supply monitoring circuits.

An input common-mode voltage range that exceeds the supplies, 20 fA input currents (typical), and a high input impedance makes the SM72375 ideal for sensor applications. The SM72375 can directly interface to sensors without the use of amplifiers or bias circuits. In circuits with sensors which produce outputs in the tens to hundreds of millivolts, the SM72375 can compare the sensor signal with an appropriately small reference voltage. This reference voltage can be close to ground or the positive supply rail.

2.0 LOW VOLTAGE OPERATION

Comparators are the common devices by which analog signals interface with digital circuits. The SM72375 is designed to operate at supply voltages of 2.7V, without sacrificing performance, to meet the demands of 3V digital systems.

At supply voltages of 2.7V, the common-mode voltage range extends 200 mV (ensured) below the negative supply. This feature, in addition to the comparator being able to sense signals near the positive rail, is extremely useful in low voltage applications.

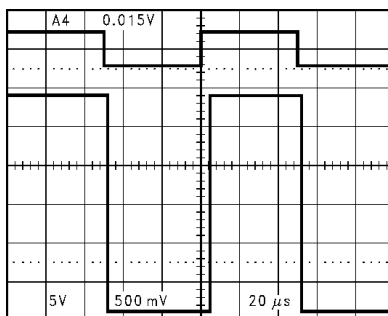

Figure 24. Even at Low-Supply Voltage of 2.7V, an Input Signal which Exceeds the Supply Voltages Produces No Phase Inversion at the Output

At $V^+ = 2.7V$, propagation delays are $t_{PLH} = 4 \mu s$ and $t_{PHL} = 4 \mu s$ with overdrives of 100 mV. Please refer to the [Typical Performance Characteristics](#) section for more extensive characterization.

3.0 OUTPUT SHORT CIRCUIT CURRENT

The SM72375 has short circuit protection of 40 mA. However, it is not designed to withstand continuous short circuits, transient voltage or current spikes, or shorts to any voltage beyond the supplies. A resistor in series with the output should reduce the effect of shorts. For outputs which send signals off PC boards additional protection devices, such as diodes to the supply rails, and varistors may be used.

4.0 HYSTERESIS

If the input signal is very noisy, the comparator output might trip several times as the input signal repeatedly passes through the threshold. This problem can be addressed by making use of hysteresis as shown below.

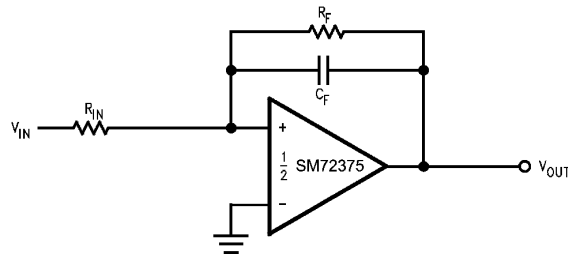

Figure 25. Canceling the Effect of Input Capacitance

The capacitor added across the feedback resistor increases the switching speed and provides more short term hysteresis. This can result in greater noise immunity for the circuit.

Typical Applications

UNIVERSAL LOGIC LEVEL SHIFTER

The output of the SM72375 is the uncommitted drain of the output NMOS transistor. Many drains can be tied together to provide an output OR'ing function. An output pullup resistor can be connected to any available power supply voltage within the permitted power supply range.

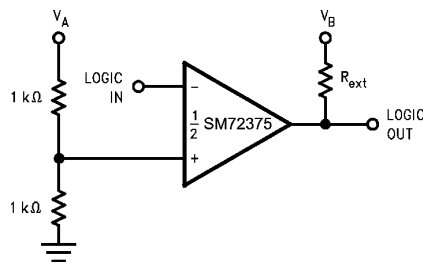

Figure 26. Universal Logic Level Shifter

The two 1 kΩ resistors bias the input to half of the power supply voltage. The pull-up resistor should go to the output logic supply. Due to its wide operating range, the SM72375 is ideal for the logic level shifting applications.

ONE-SHOT MULTIVIBRATOR

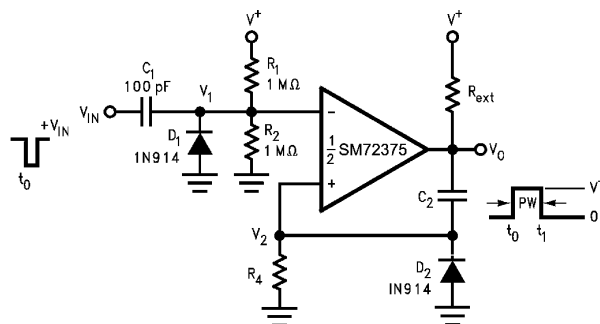

Figure 27. One-Shot Multivibrator

A monostable multivibrator has one stable state in which it can remain indefinitely. It can be triggered externally to another quasi-stable state. A monostable multivibrator can thus be used to generate a pulse of desired width.

The desired pulse width is set by adjusting the values of C_2 and R_4 . The resistor divider of R_1 and R_2 can be used to determine the magnitude of the input trigger pulse. The SM72375 will change state when $V_1 < V_2$. Diode D_2 provides a rapid discharge path for capacitor C_2 to reset at the end of the pulse. The diode also prevents the non-inverting input from being driven below ground.

BI-STABLE MULTIVIBRATOR

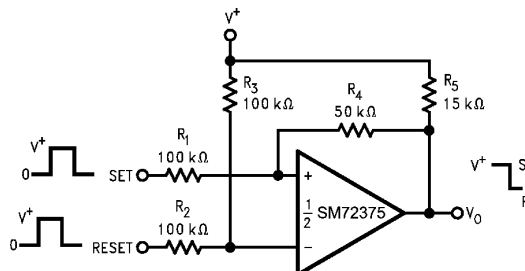

Figure 28. Bi-Stable Multivibrator

A bi-stable multivibrator has two stable states. The reference voltage is set up by the voltage divider of R_2 and R_3 . A pulse applied to the SET terminal will switch the output of the comparator high. The resistor divider of R_1 , R_4 , and R_5 now clamps the non-inverting input to a voltage greater than the reference voltage. A pulse applied to RESET will now toggle the output low.

ZERO CROSSING DETECTOR

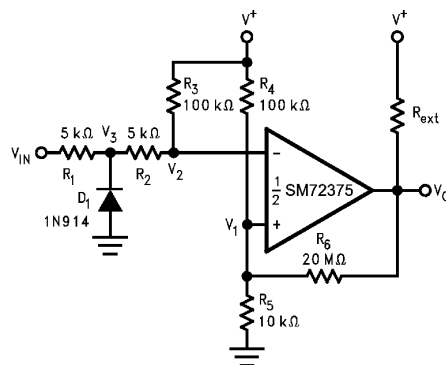

Figure 29. Zero Crossing Detector

A voltage divider of R_4 and R_5 establishes a reference voltage V_1 at the non-inverting input. By making the series resistance of R_1 and R_2 equal to R_5 , the comparator will switch when $V_{IN} = 0$. Diode D_1 insures that V_3 never drops below $-0.7V$. The voltage divider of R_2 and R_3 then prevents V_2 from going below ground. A small amount of hysteresis is setup to ensure rapid output voltage transitions.

OSCILLATOR

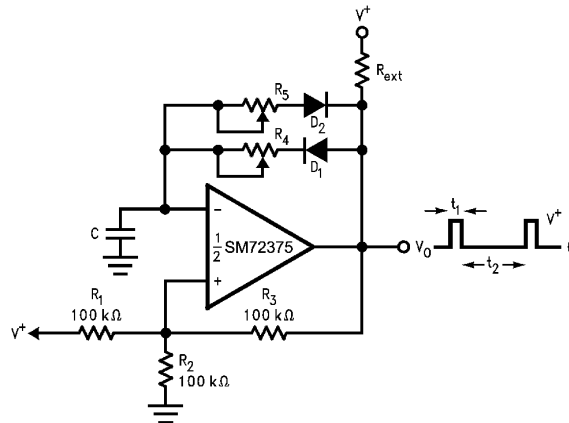

Figure 30. Square Wave Generator

Figure 30 shows the application of the SM72375 in a square wave generator circuit. The total hysteresis of the loop is set by R_1 , R_2 and R_3 . R_4 and R_5 provide separate charge and discharge paths for the capacitor C . The charge path is set through R_4 and D_1 . So, the pulse width t_1 is determined by the RC time constant of R_4 and C . Similarly, the discharge path for the capacitor is set by R_5 and D_2 . Thus, the time t_2 between the pulses can be changed by varying R_5 , and the pulse width can be altered by R_4 . The frequency of the output can be changed by varying both R_4 and R_5 .

REVISION HISTORY

Changes from Revision C (April 2013) to Revision D	Page
• Changed layout of National Data Sheet to TI format	13

PACKAGING INFORMATION

Orderable Device	Status (1)	Package Type	Package Drawing	Pins	Package Qty	Eco Plan (2)	Lead/Ball Finish	MSL Peak Temp (3)	Op Temp (°C)	Top-Side Markings (4)	Samples
SM72375MM/NOPB	ACTIVE	VSSOP	DGK	8	1000	Green (RoHS & no Sb/Br)	CU SN	Level-1-260C-UNLIM	-40 to 125	S375	Samples
SM72375MME/NOPB	ACTIVE	VSSOP	DGK	8	250	Green (RoHS & no Sb/Br)	CU SN	Level-1-260C-UNLIM	-40 to 125	S375	Samples
SM72375MMX/NOPB	ACTIVE	VSSOP	DGK	8	3500	Green (RoHS & no Sb/Br)	CU SN	Level-1-260C-UNLIM	-40 to 125	S375	Samples

(1) The marketing status values are defined as follows:

ACTIVE: Product device recommended for new designs.

LIFEBUY: TI has announced that the device will be discontinued, and a lifetime-buy period is in effect.

NRND: Not recommended for new designs. Device is in production to support existing customers, but TI does not recommend using this part in a new design.

PREVIEW: Device has been announced but is not in production. Samples may or may not be available.

OBSOLETE: TI has discontinued the production of the device.

(2) Eco Plan - The planned eco-friendly classification: Pb-Free (RoHS), Pb-Free (RoHS Exempt), or Green (RoHS & no Sb/Br) - please check <http://www.ti.com/productcontent> for the latest availability information and additional product content details.

TBD: The Pb-Free/Green conversion plan has not been defined.

Pb-Free (RoHS): TI's terms "Lead-Free" or "Pb-Free" mean semiconductor products that are compatible with the current RoHS requirements for all 6 substances, including the requirement that lead not exceed 0.1% by weight in homogeneous materials. Where designed to be soldered at high temperatures, TI Pb-Free products are suitable for use in specified lead-free processes.

Pb-Free (RoHS Exempt): This component has a RoHS exemption for either 1) lead-based flip-chip solder bumps used between the die and package, or 2) lead-based die adhesive used between the die and leadframe. The component is otherwise considered Pb-Free (RoHS compatible) as defined above.

Green (RoHS & no Sb/Br): TI defines "Green" to mean Pb-Free (RoHS compatible), and free of Bromine (Br) and Antimony (Sb) based flame retardants (Br or Sb do not exceed 0.1% by weight in homogeneous material)

(3) MSL, Peak Temp. -- The Moisture Sensitivity Level rating according to the JEDEC industry standard classifications, and peak solder temperature.

(4) Multiple Top-Side Markings will be inside parentheses. Only one Top-Side Marking contained in parentheses and separated by a "~" will appear on a device. If a line is indented then it is a continuation of the previous line and the two combined represent the entire Top-Side Marking for that device.

Important Information and Disclaimer: The information provided on this page represents TI's knowledge and belief as of the date that it is provided. TI bases its knowledge and belief on information provided by third parties, and makes no representation or warranty as to the accuracy of such information. Efforts are underway to better integrate information from third parties. TI has taken and continues to take reasonable steps to provide representative and accurate information but may not have conducted destructive testing or chemical analysis on incoming materials and chemicals. TI and TI suppliers consider certain information to be proprietary, and thus CAS numbers and other limited information may not be available for release.

In no event shall TI's liability arising out of such information exceed the total purchase price of the TI part(s) at issue in this document sold by TI to Customer on an annual basis.

TAPE AND REEL INFORMATION

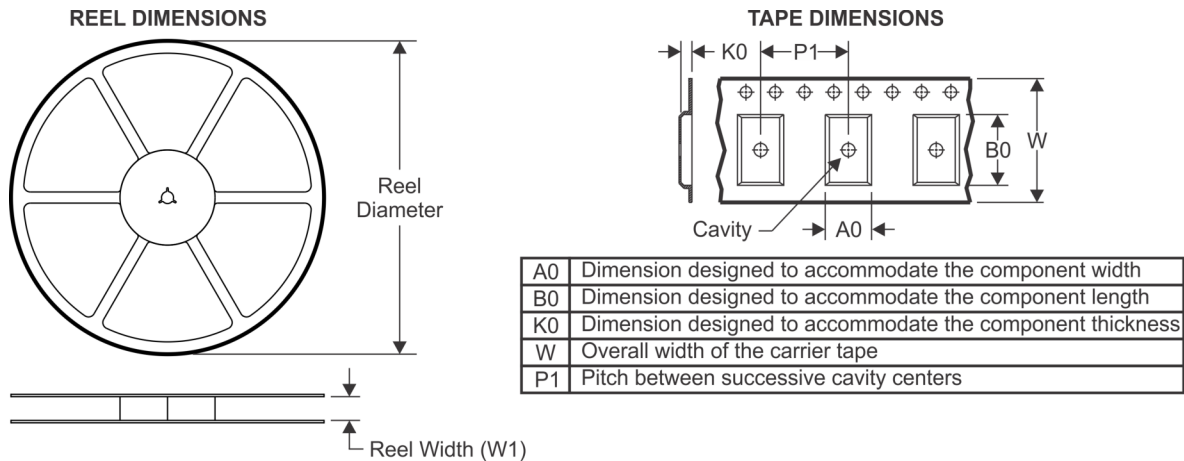

QUADRANT ASSIGNMENTS FOR PIN 1 ORIENTATION IN TAPE

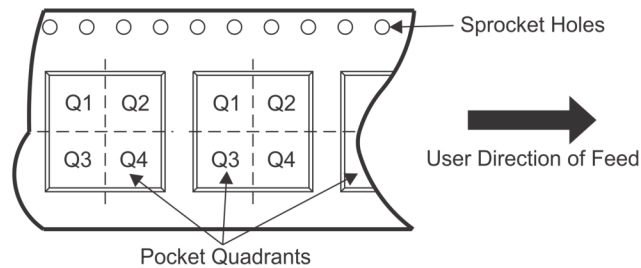

*All dimensions are nominal

Device	Package Type	Package Drawing	Pins	SPQ	Reel Diameter (mm)	Reel Width W1 (mm)	A0 (mm)	B0 (mm)	K0 (mm)	P1 (mm)	W (mm)	Pin1 Quadrant
SM72375MM/NOPB	VSSOP	DGK	8	1000	178.0	12.4	5.3	3.4	1.4	8.0	12.0	Q1
SM72375MME/NOPB	VSSOP	DGK	8	250	178.0	12.4	5.3	3.4	1.4	8.0	12.0	Q1
SM72375MMX/NOPB	VSSOP	DGK	8	3500	330.0	12.4	5.3	3.4	1.4	8.0	12.0	Q1

TAPE AND REEL BOX DIMENSIONS



*All dimensions are nominal

Device	Package Type	Package Drawing	Pins	SPQ	Length (mm)	Width (mm)	Height (mm)
SM72375MM/NOPB	VSSOP	DGK	8	1000	210.0	185.0	35.0
SM72375MME/NOPB	VSSOP	DGK	8	250	210.0	185.0	35.0
SM72375MMX/NOPB	VSSOP	DGK	8	3500	367.0	367.0	35.0

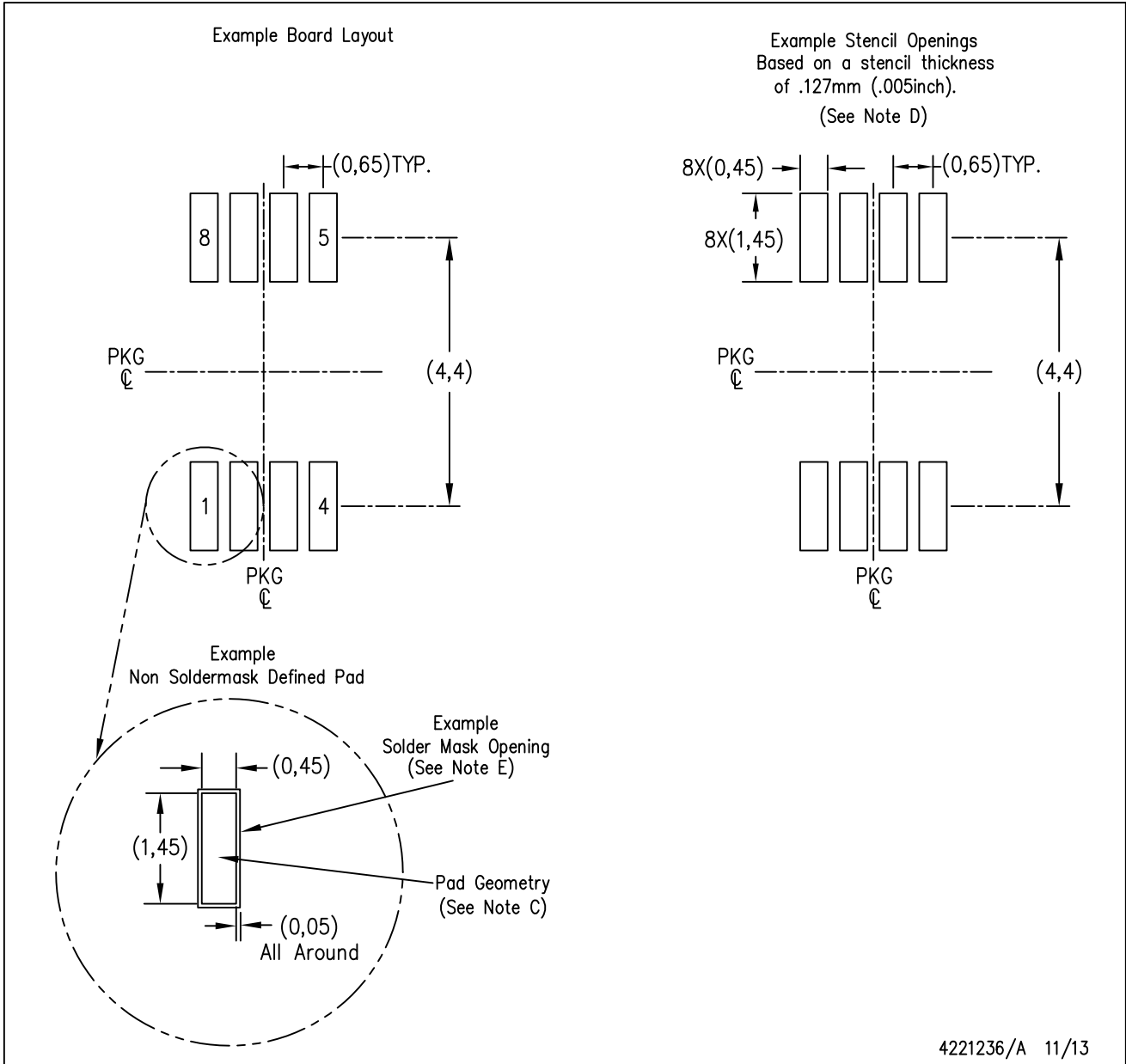

- NOTES:
- A. All linear dimensions are in millimeters.
 - B. This drawing is subject to change without notice.
 - C. Publication IPC-7351 is recommended for alternate designs.
 - D. Laser cutting apertures with trapezoidal walls and also rounding corners will offer better paste release. Customers should contact their board assembly site for stencil design recommendations. Refer to IPC-7525 for other stencil recommendations.
 - E. Customers should contact their board fabrication site for solder mask tolerances between and around signal pads.

IMPORTANT NOTICE

Texas Instruments Incorporated and its subsidiaries (TI) reserve the right to make corrections, enhancements, improvements and other changes to its semiconductor products and services per JESD46, latest issue, and to discontinue any product or service per JESD48, latest issue. Buyers should obtain the latest relevant information before placing orders and should verify that such information is current and complete. All semiconductor products (also referred to herein as "components") are sold subject to TI's terms and conditions of sale supplied at the time of order acknowledgment.

TI warrants performance of its components to the specifications applicable at the time of sale, in accordance with the warranty in TI's terms and conditions of sale of semiconductor products. Testing and other quality control techniques are used to the extent TI deems necessary to support this warranty. Except where mandated by applicable law, testing of all parameters of each component is not necessarily performed.

TI assumes no liability for applications assistance or the design of Buyers' products. Buyers are responsible for their products and applications using TI components. To minimize the risks associated with Buyers' products and applications, Buyers should provide adequate design and operating safeguards.

TI does not warrant or represent that any license, either express or implied, is granted under any patent right, copyright, mask work right, or other intellectual property right relating to any combination, machine, or process in which TI components or services are used. Information published by TI regarding third-party products or services does not constitute a license to use such products or services or a warranty or endorsement thereof. Use of such information may require a license from a third party under the patents or other intellectual property of the third party, or a license from TI under the patents or other intellectual property of TI.

Reproduction of significant portions of TI information in TI data books or data sheets is permissible only if reproduction is without alteration and is accompanied by all associated warranties, conditions, limitations, and notices. TI is not responsible or liable for such altered documentation. Information of third parties may be subject to additional restrictions.

Resale of TI components or services with statements different from or beyond the parameters stated by TI for that component or service voids all express and any implied warranties for the associated TI component or service and is an unfair and deceptive business practice. TI is not responsible or liable for any such statements.

Buyer acknowledges and agrees that it is solely responsible for compliance with all legal, regulatory and safety-related requirements concerning its products, and any use of TI components in its applications, notwithstanding any applications-related information or support that may be provided by TI. Buyer represents and agrees that it has all the necessary expertise to create and implement safeguards which anticipate dangerous consequences of failures, monitor failures and their consequences, lessen the likelihood of failures that might cause harm and take appropriate remedial actions. Buyer will fully indemnify TI and its representatives against any damages arising out of the use of any TI components in safety-critical applications.

In some cases, TI components may be promoted specifically to facilitate safety-related applications. With such components, TI's goal is to help enable customers to design and create their own end-product solutions that meet applicable functional safety standards and requirements. Nonetheless, such components are subject to these terms.

No TI components are authorized for use in FDA Class III (or similar life-critical medical equipment) unless authorized officers of the parties have executed a special agreement specifically governing such use.

Only those TI components which TI has specifically designated as military grade or "enhanced plastic" are designed and intended for use in military/aerospace applications or environments. Buyer acknowledges and agrees that any military or aerospace use of TI components which have **not** been so designated is solely at the Buyer's risk, and that Buyer is solely responsible for compliance with all legal and regulatory requirements in connection with such use.

TI has specifically designated certain components as meeting ISO/TS16949 requirements, mainly for automotive use. In any case of use of non-designated products, TI will not be responsible for any failure to meet ISO/TS16949.

Products

Audio	www.ti.com/audio
Amplifiers	amplifier.ti.com
Data Converters	dataconverter.ti.com
DLP® Products	www.dlp.com
DSP	dsp.ti.com
Clocks and Timers	www.ti.com/clocks
Interface	interface.ti.com
Logic	logic.ti.com
Power Mgmt	power.ti.com
Microcontrollers	microcontroller.ti.com
RFID	www.ti-rfid.com
OMAP Applications Processors	www.ti.com/omap
Wireless Connectivity	www.ti.com/wirelessconnectivity

Applications

Automotive and Transportation	www.ti.com/automotive
Communications and Telecom	www.ti.com/communications
Computers and Peripherals	www.ti.com/computers
Consumer Electronics	www.ti.com/consumer-apps
Energy and Lighting	www.ti.com/energy
Industrial	www.ti.com/industrial
Medical	www.ti.com/medical
Security	www.ti.com/security
Space, Avionics and Defense	www.ti.com/space-avionics-defense
Video and Imaging	www.ti.com/video

TI E2E Community

e2e.ti.com