



HUIYUAN OPTO-ELECTRONIC CO.,LTD.

TECHNOLOGY DATA SHEET & SPECIFICATIONS

MODEL: 2534W2D-KHA-A

Features

- High efficiency
- Low Power consumption
- General purpose leads
- Selected minimum intensities
- Available on tape and reel
- Pb free

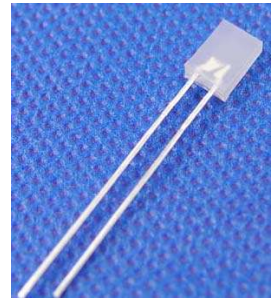

Descriptions

- The series is specially designed for applications requiring higher brightness
- The LED lamps are available with different colors, intensities, epoxy colors, etc
- Superior performance in outdoor environment

Usage Notes:

- The ultra bright LED is an electrostatic insensitive device,so static electricity and surge will damage the LED.It is required to wear a wrist-band when handling the LED. All device, equipment,machinery, desk and ground must be properly grounded
- When using LED, it must use a protective resistor in series with DC current about 20mA

Applications

- Status indicators
- Commercial use
- Advertising Signs
- Back lighting.



TECHNOLOGY DATA SHEET & SPECIFICATIONS

MODEL: 2534W2D-KHA-A

Device Selection Guide

LED Part No.	Chip		Lens Color
	Material	Emitted Color	
2534W2D-KHA-A	InGaN	White	Diffused

Package Dimensions

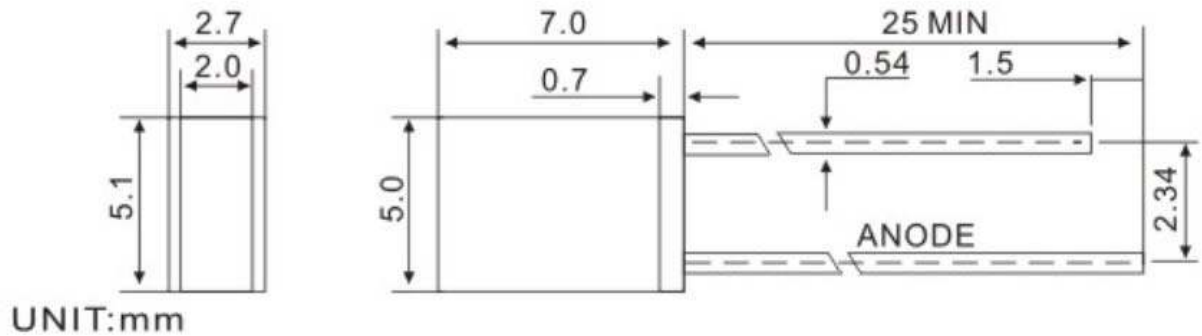

Notes:

*Other dimensions are in millimeters, tolerance is 0.25mm except being specified.

*Protruded resin under flange is 1.5mm Max LED.

*Bare copper alloy is exposed at tie-bar portion after cutting.



TECHNOLOGY DATA SHEET & SPECIFICATIONS

MODEL: 2534W2D-KHA-A

Electro-Optical Characteristics (T_a=25℃)

Parameter	Symbol	Min.	Typ.	Max.	Unit	Test Condition
Luminous Intensity	I _v	100	---	250	mcd	IF=20mA(Note 1)
Viewing Angle	2θ _{1/2}	---	120	---	Deg	(Note 2)
Color Temperature	CT	5500	---	6500	K	IF=20mA
Spectral Line Half-Width	Δλ	25	30	35	nm	IF=20mA
Forward Voltage	V _F	2.9	---	3.5	V	IF=20mA
Reverse Current	I _R	---	---	10	μA	VR=5V

Note:

1. Luminous intensity is measured with a light sensor and filter combination that approximates the CIE eye-response curve.
2. θ_{1/2} is the off-axis angle at which the luminous intensity is half the axial luminous intensity.



TECHNOLOGY DATA SHEET & SPECIFICATIONS

MODEL: 2534W2D-KHA-A

Typical Electro-Optical Characteristics Curves

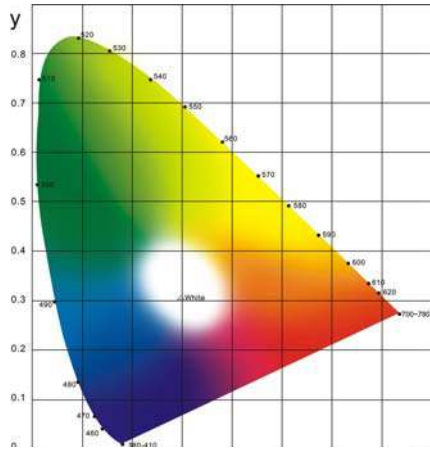

Relative Intensity VS. Ambient Temp

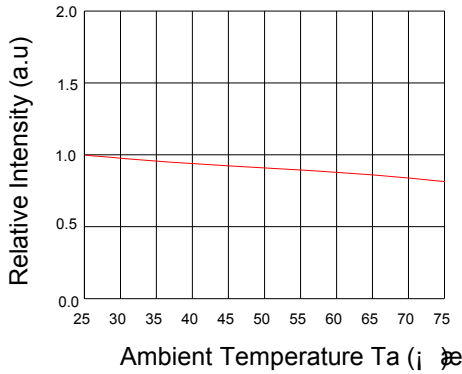

Forward Current VS.Ambient Temp.

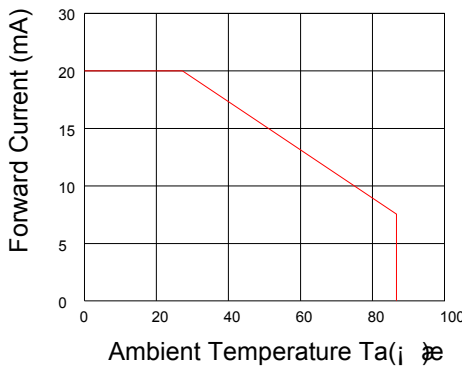

Forward Current VS.Forward Voltage

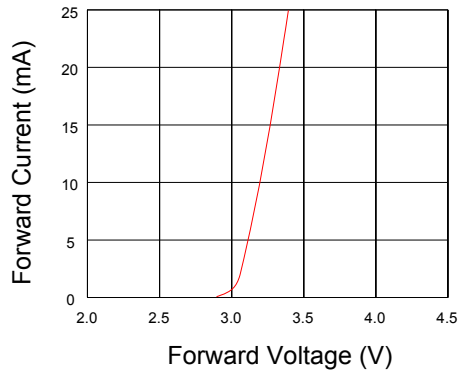

Forward Current VS.Relative Intensity

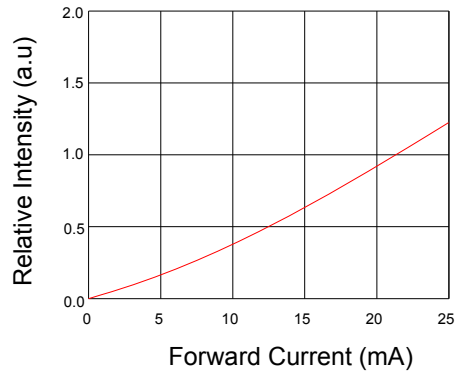

Radiation Characteristics

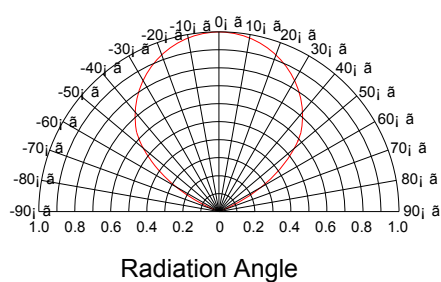



HUIYUAN OPTO-ELECTRONIC CO.,LTD.

TECHNOLOGY DATA SHEET & SPECIFICATIONS

MODEL: 2534W2D-KHA-A

Notes

1. Above specification may be changed without notice. Hyled will reserve authority on material change for above specification.
2. When using this product, please observe the absolute maximum ratings and the instructions for using outlined in these specification sheets. Hyled assumes no responsibility for any damage resulting from use of the product which does not comply with the absolute maximum ratings and the instructions included in these specification sheets.
3. These specification sheets include materials protected under copyright of Hyled corporation. Please don't reproduce or cause anyone to reproduce them without Hyled's consent.