



E-CORE PAR16

3,5W / 5,4W / 9W

The elegant mains-voltage spotlights with robust GU10 base shine with their excellent energy-saving credentials and ease of use. Suitable for a multitude of uses, they can be dimmed to offer atmospheric lighting or daylight-brightness accents – even at considerable distance.

Application:

- + Accent Lighting
- + Display Lighting
- + Residential Lighting

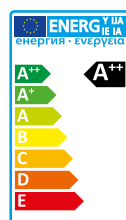
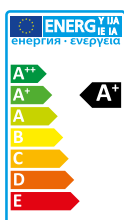
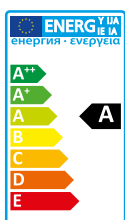

Product details

- + Elegant high-voltage spotlights with GU10 bayonet base
- + Highly efficient and energy saving
- + Dimmable
- + Focussed light with different beam angles
- + Mercury free
- + Reduction of energy consumption of up to 85%
- + Low IR or UV radiation
- + Life time up to 40,000 hours
- + Pleasant warm or neutral white light
- + Instant light
- + Outstanding light quality delivered by great optics

Optical parameters

MODEL NAME	E-CORE PAR16 3,5W		
Product code	LDRC0427MU1EU2 / LDRC0427WU1EU2	LDRC0430MU1EU2 / LDRC0430WU1EU2	LDRC0440MU1EU2 / LDRC0440WU1EU2
Luminous flux	230 lm	230 lm	250 lm
Colour description	Warm white	Warm white	Neutral white
Colour temperature	2700 K	3000 K	4000 K
Colour rendering index	80 Ra	80 Ra	80 Ra
Colour consistency	6 SDCM	6 SDCM	6 SDCM
Beam angle	25° / 40°	25° / 40°	25° / 40°
Luminous intensity	900 / 450 cd	900 / 450 cd	960 / 480 cd
Lumen maintenance factor	L70	L70	L70
Lamp efficacy	65.7 lm/W	65.7 lm/W	71.4 lm/W
Energy class	A+	A+	A++

MODEL NAME	E-CORE PAR16 5,4W		
Product code	LDRC0527MU1EUD / LDRC0527WU1EUD	LDRC0530MU1EUD / LDRC0530WU1EUD	LDRC0640MU1EUD2 / LDRC0640WU1EUD2
Luminous flux	355 lm	355 lm	370 lm
Colour description	Warm white	Warm white	Neutral white
Colour temperature	2700 K	3000 K	4000 K
Colour rendering index	80 Ra	80 Ra	80 Ra
Colour consistency	6 SDCM	6 SDCM	6 SDCM
Beam angle	25° / 40°	25° / 40°	25° / 40°
Luminous intensity	1,320 / 640 cd	1,320 / 640 cd	1,420 / 680 cd
Lumen maintenance factor	L70	L70	L70
Lamp efficacy	65.7 lm/W	65.7 lm/W	68.5 lm/W
Energy class	A+	A+	A+

MODEL NAME	E-CORE PAR16 9W		
Product code	LDRC0927MU1EUD2 / LDRC0927WU1EUD2	LDRC0930MU1EUD2 / LDRC0930WU1EUD2	LDRC0940MU1EUD2 / LDRC0940WU1EUD2
Luminous flux	520 lm	550 lm	580 lm
Colour description	Warm white	Warm white	Neutral white
Colour temperature	2700 K	3000 K	4000 K
Colour rendering index	80 Ra	80 Ra	80 Ra
Colour consistency	6 SDCM	6 SDCM	6 SDCM
Beam angle	25° / 40°	25° / 40°	25° / 40°
Luminous intensity	1,900 / 950 cd	2,000 / 1,000 cd	2,000 / 1,000 cd
Lumen maintenance factor	L70	L70	L70
Lamp efficacy	57.8 lm/W	61.1 lm/W	64.4 lm/W
Energy class	A	A	A+

Optical parameters for E-CORE PAR16 3,5W

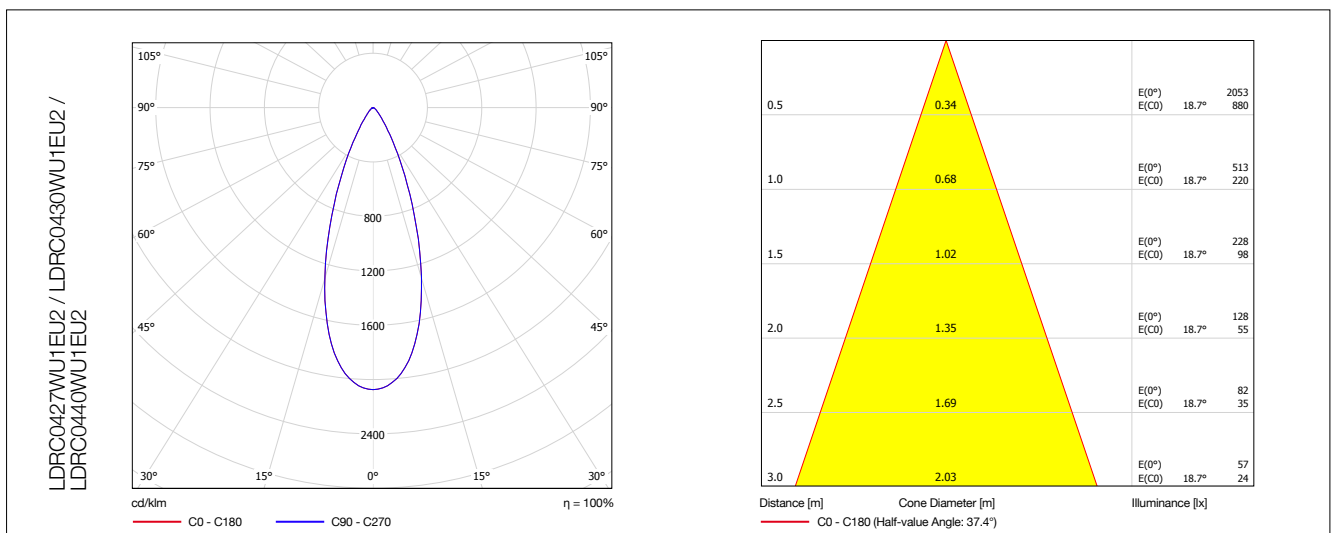
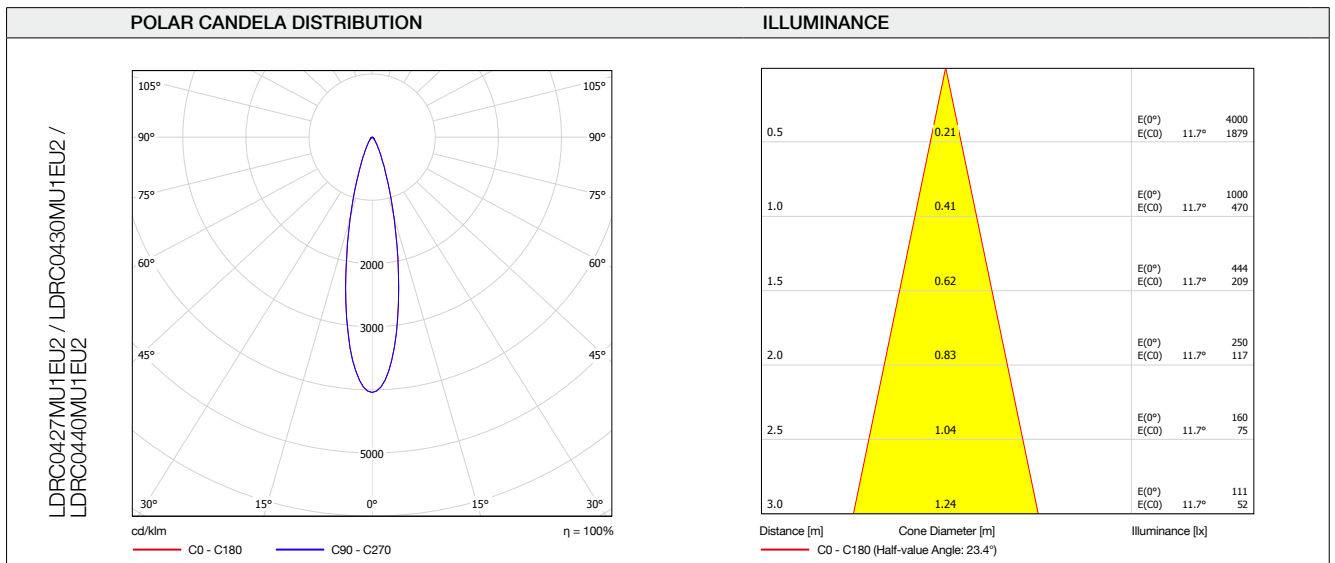

Optical parameters for E-CORE PAR16 5,4W

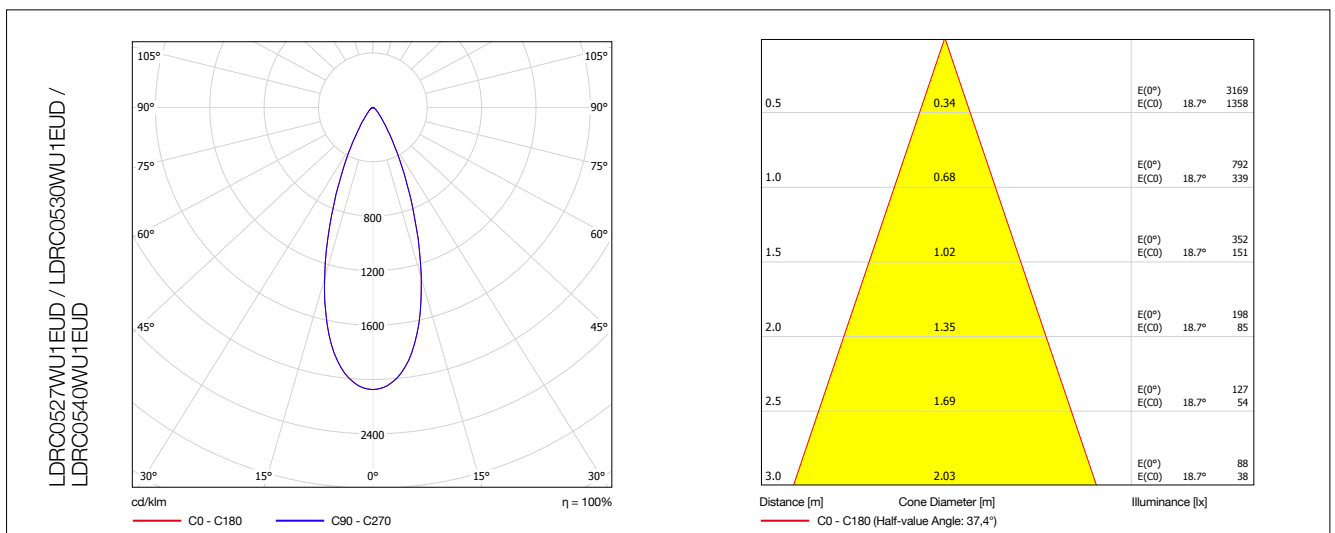
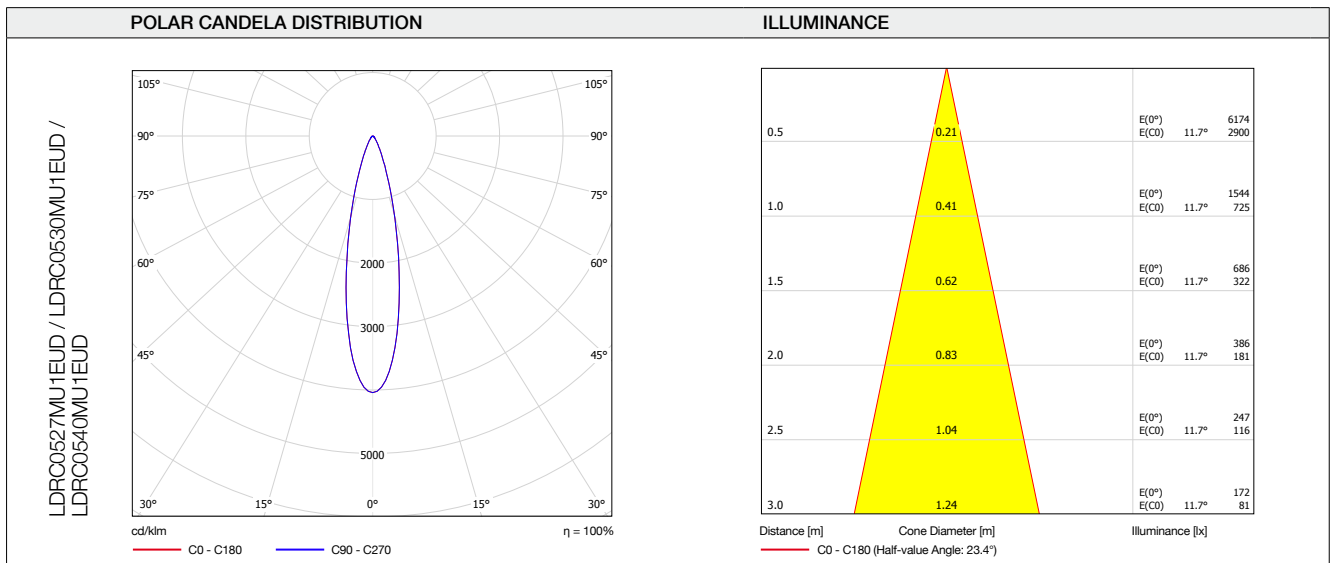

Optical parameters for E-CORE PAR16 9W

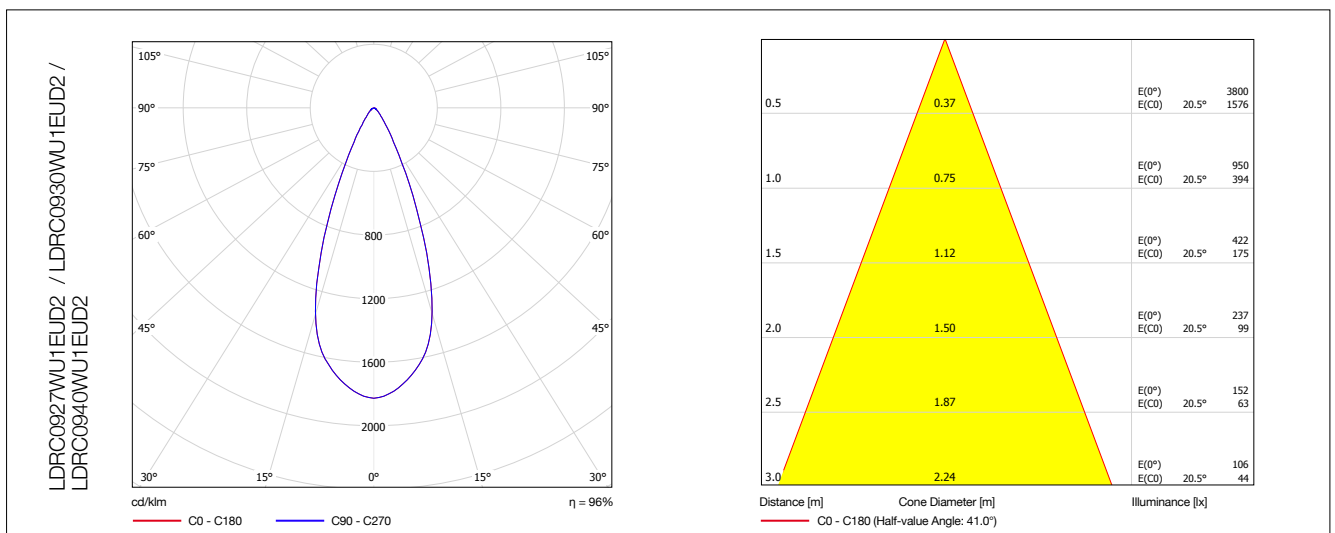
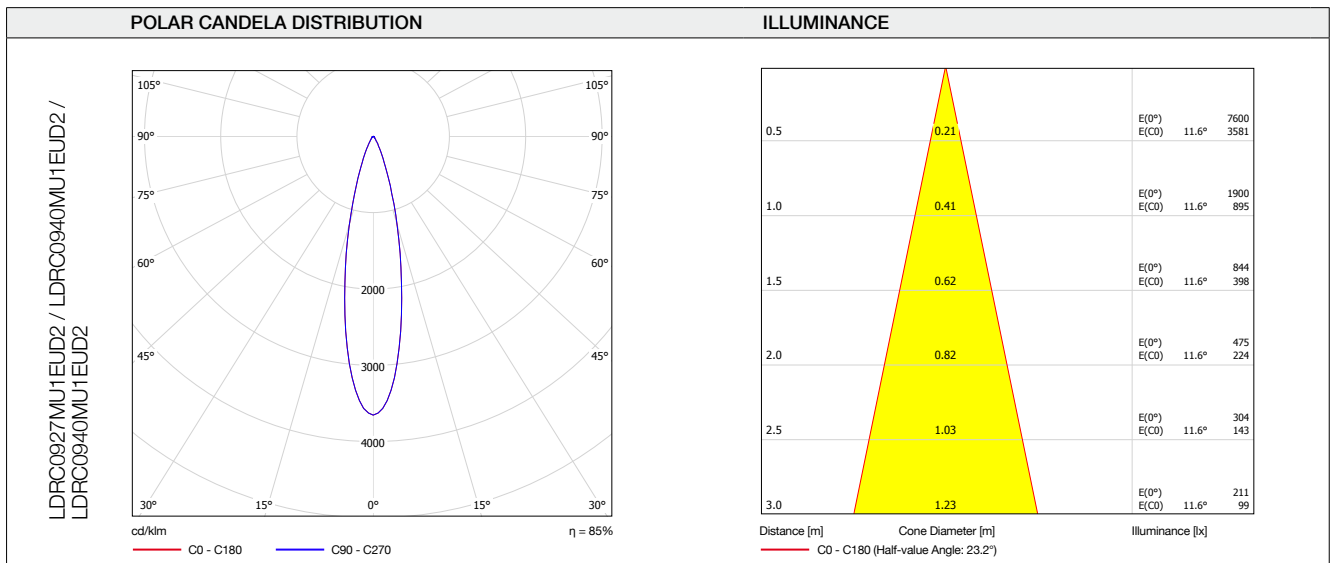

Electrical parameters

MODEL NAME	E-CORE PAR16 3,5W		
Product code	LDRC0427MU1EU2 / LDRC0427WU1EU2	LDRC0430MU1EU2 / LDRC0430WU1EU2	LDRC0440MU1EU2 / LDRC0440WU1EU2
Rated voltage	220-240 V	220-240 V	220-240 V
Rated wattage	3.5 W	3.5 W	3.5 W
Frequency	50 / 60 Hz	50 / 60 Hz	50 / 60 Hz
Rated input current	30 mA	30 mA	30 mA
Power factor	0.51	0.51	0.51
Rated lifetime	40,000 h	40,000 h	40,000 h
Switching cycle	> 15,000	> 15,000	> 15,000
Starting time	< 0.5 sec	< 0.5 sec	< 0.5 sec
Warm-up time	Instant full light	Instant full light	Instant full light
Dimming*	Not dimmable	Not dimmable	Not dimmable

MODEL NAME	E-CORE PAR16 5,4W		
Product code	LDRC0527MU1EUD / LDRC0527WU1EUD	LDRC0530MU1EUD / LDRC0530WU1EUD	LDRC0540MU1EUD / LDRC0540WU1EUD
Rated voltage	220-240 V	220-240 V	220-240 V
Rated wattage	5.4 W	5.4 W	5.4 W
Frequency	50 / 60 Hz	50 / 60 Hz	50 / 60 Hz
Rated input current	36.5 mA	36.5 mA	36.5 mA
Power factor	0.64	0.64	0.64
Rated lifetime	40,000 h	40,000 h	40,000 h
Switching cycle	> 15,000	> 15,000	> 15,000
Starting time	< 0.5 sec	< 0.5 sec	< 0.5 sec
Warm-up time	Instant full light	Instant full light	Instant full light
Dimming*	Yes, 10-100%	Yes, 10-100%	Yes, 10-100%

MODEL NAME	E-CORE PAR16 9W		
Product code	LDRC0927MU1EUD2 / LDRC0927WU1EUD2	LDRC0930MU1EUD2 / LDRC0930WU1EUD2	LDRC0940MU1EUD2 / LDRC0940WU1EUD2
Rated voltage	220-240 V	220-240 V	220-240 V
Rated wattage	9 W	9 W	9 W
Frequency	50 / 60 Hz	50 / 60 Hz	50 / 60 Hz
Rated input current	46 mA	46 mA	46 mA
Power factor	0.85	0.85	0.85
Rated lifetime	40,000 h	40,000 h	40,000 h
Switching cycle	> 15,000	> 15,000	> 15,000
Starting time	< 0.5 sec	< 0.5 sec	< 0.5 sec
Warm-up time	Instant full light	Instant full light	Instant full light
Dimming*	Yes, 10-100%	Yes, 10-100%	Yes, 10-100%

* Dimmable on suitable dimmers.

Mechanical parameters

MODEL NAME	E-CORE PAR16 3,5W		
Product code	LDRC0427MU1EU2 / LDRC0427WU1EU2	LDRC0430MU1EU2 / LDRC0430WU1EU2	LDRC0440MU1EU2 / LDRC0440WU1EU2
Overall length	55 mm	55 mm	55 mm
Diameter	50 mm	50 mm	50 mm
Net weight	45 g	45 g	45 g
Cap	GU10	GU10	GU10

MODEL NAME	E-CORE PAR16 5,4W		
Product code	LDRC0527MU1EUD / LDRC0527WU1EUD	LDRC0530MU1EUD / LDRC0530WU1EUD	LDRC0540MU1EUD / LDRC0540WU1EUD
Overall length	55 mm	55 mm	55 mm
Diameter	50 mm	50 mm	50 mm
Net weight	50 g	50 g	50 g
Cap	GU10	GU10	GU10

MODEL NAME	E-CORE PAR16 9W		
Product code	LDRC0927MU1EUD2 / LDRC0927WU1EUD2	LDRC0930MU1EUD2 / LDRC0930WU1EUD2	LDRC0940MU1EUD2 / LDRC0940WU1EUD2
Overall length	80 mm	80 mm	80 mm
Diameter	50 mm	50 mm	50 mm
Net weight	140 g	140 g	140 g
Cap	GU10	GU10	GU10

Drawings

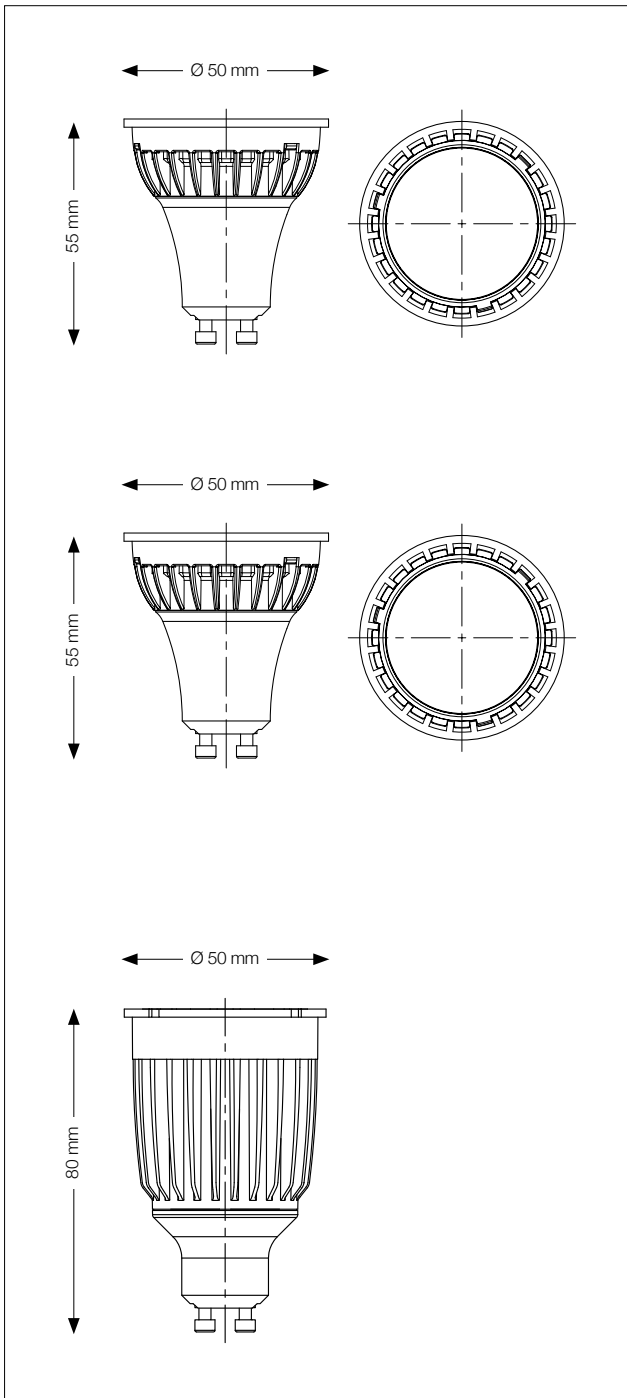

According to
ErP 1194/2012

Dimmability

The LED-Lamps can be dimmed in a range of 10%-100% by Trailing-edge dimmers. A general compatibility to all dimmers can't be granted. A list of recommended dimmers can be found on our website www.toshiba.eu/lighting.

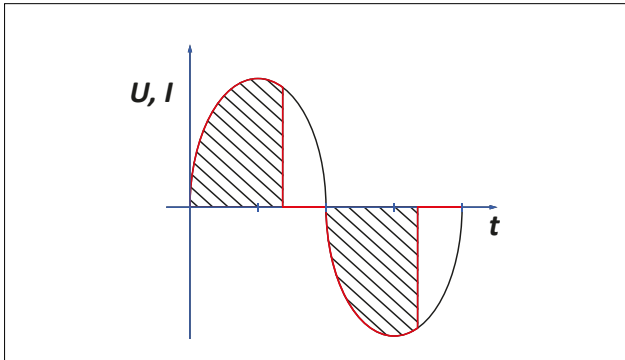

RECOMMENDED DIMMERS FOR MAX. 8 LAMPS WITH A DIMMING OF 10 %-100 %:

AURORA AU-DSP250 250W	AURORA AU-DSP400 400W	BERKER 2830_10 60-400W
BERKER 2873 20-500W	BUSCH-JAEGER 6513U-102 40-420W	BUSCH-JAEGER 2247U 500W
BUSCH-JAEGER 2250U 600W	CONRAD EMD200 40-300W	CRABTREE BQLP003 60-400W
DANLERS DP1D250WIET 40-250W	DANLERS DP1D400WIET 40-400W	DANLERS DP1D250W 40-250W
DETA S1253 400W	GIRA 030200 100 60-600W	HAGER EV100 1000W
JUNG 225NV DE 20-500W	JUNG 266GDE 60-600W	JUNG 225T DE 20-525W
LUTRON LLSM-502H 40-500W	MK K1501 WHI LV 60-500W	NEWLEC GET NL1131N 60-250W
PEHA 436 60-600W	PEHA 435HAN 60-600W	RVE RV5 1000W
SCHNEIDER UNICA TOP 511 500W	SOLOGIC 28956 20-400W	SOLOGIC 28969 20-600W

Important notes

LED lamps are not resistive loads for the dimmers and therefore the power rating of the dimmer can't be directly converted. Incompatibilities between LED lamp and dimmer are expressed as flickering and restrictions in the dimming range.

* Some dimmers may cause flickering and no dimming at lower level. When the dimmer is connected to numerous lamps, it may not be possible to dim the light to the lowest possible levels. Respective timing on dimming each lamp may differ. When turning on the lamp from 100% dimming, the lamp may not turn back on. Increase dimmer to higher level until lamp turns on.

Logistic data

PRODUCT CODE / 3,5W	EAN/ITF CODE	PACKAGING TYPE	SIZE OF PACKAGING (mm) L x H x W	GROSS WEIGHT (g)
LDRC0427MU1EU2	4974550463003	Gift box (1pce)	58 x 55 x 86	78
	14974550463000	Carton (10pcs)	282 x 122 x 95	880
LDRC0427WU1EU2	4974550463010	Gift box (1pce)	58 x 55 x 86	78
	14974550463017	Carton (10pcs)	282 x 122 x 95	880
LDRC0430MU1EU2	4974550463027	Gift box (1pce)	58 x 55 x 86	78
	14974550463024	Carton (10pcs)	282 x 122 x 95	880
LDRC0430WU1EU2	4974550463034	Gift box (1pce)	58 x 55 x 86	78
	14974550463031	Carton (10pcs)	282 x 122 x 95	880
LDRC0440MU1EU2	4974550463041	Gift box (1pce)	58 x 55 x 86	78
	14974550463048	Carton (10pcs)	282 x 122 x 95	880
LDRC0440WU1EU2	4974550463058	Gift box (1pce)	58 x 55 x 86	78
	14974550463055	Carton (10pcs)	282 x 122 x 95	880

PRODUCT CODE / 5,4W	EAN/ITF CODE	PACKAGING TYPE	SIZE OF PACKAGING (mm) L x H x W	GROSS WEIGHT (g)
LDRC0527MU1EUD	4974550462945	Gift box (1pce)	58 x 55 x 86	83
	14974550462942	Carton (10pcs)	282 x 122 x 95	980
LDRC0527WU1EUD	4974550462952	Gift box (1pce)	58 x 55 x 86	83
	14974550462959	Carton (10pcs)	282 x 122 x 95	980
LDRC0530MU1EUD	4974550462969	Gift box (1pce)	58 x 55 x 86	83
	14974550462966	Carton (10pcs)	282 x 122 x 95	980
LDRC0530WU1EUD	4974550462976	Gift box (1pce)	58 x 55 x 86	83
	14974550462973	Carton (10pcs)	282 x 122 x 95	980
LDRC0540MU1EUD	4974550462983	Gift box (1pce)	58 x 55 x 86	83
	14974550462980	Carton (10pcs)	282 x 122 x 95	980
LDRC0540WU1EUD	4974550462990	Gift box (1pce)	58 x 55 x 86	83
	14974550462997	Carton (10pcs)	282 x 122 x 95	980

PRODUCT CODE / 9W	EAN/ITF CODE	PACKAGING TYPE	SIZE OF PACKAGING (mm) L x H x W	GROSS WEIGHT (g)
LDRC0927MU1EUD2	4974550447294	Gift box (1pce)	63 x 55 x 120	180
	24974550447298	Carton (10pcs)	282 x 132 x 130	1,910
	14974550447291	Carton (20pcs)	292 x 142 x 280	4,020
LDRC0927WU1EUD2	4974550447300	Gift box (1pce)	63 x 55 x 120	180
	24974550447304	Carton (10pcs)	282 x 132 x 130	1,910
	14974550447307	Carton (20pcs)	292 x 142 x 280	4,020
LDRC0930MU1EUD2	4974550447317	Gift box (1pce)	63 x 55 x 120	180
	24974550447311	Carton (10pcs)	282 x 132 x 130	1,910
	14974550447314	Carton (20pcs)	292 x 142 x 280	4,020
LDRC0930WU1EUD2	4974550447324	Gift box (1pce)	63 x 55 x 120	180
	24974550447328	Carton (10pcs)	282 x 132 x 130	1,910
	14974550447321	Carton (20pcs)	292 x 142 x 280	4,020
LDRC0940MU1EUD2	4974550447331	Gift box (1pce)	63 x 55 x 120	180
	24974550447328	Carton (10pcs)	282 x 132 x 130	1,910
	14974550447338	Carton (20pcs)	292 x 142 x 280	4,020
LDRC0940WU1EUD2	4974550447348	Gift box (1pce)	63 x 55 x 120	180
	24974550447342	Carton (10pcs)	282 x 132 x 130	1,910
	14974550447345	Carton (20pcs)	292 x 142 x 280	4,020

Handling and safety information

- + Do not cover the lamp with paper, cloth or other easily flammable materials
- + Do not expose the lamp to water or high humidity
- + Avoid additional mechanical stress on the lamp
- + Do not touch the lamp during or shortly after usage. Risk of burn!
- + Use only with recommended drivers
- + Ambient temperature range: +5 °C to +40 °C
- + Do not look directly into the lamp
- + Do not spray pesticide on this lamp
- + Please ensure the mains power is disconnected before undertaking any work on the luminaire or lamp

www.toshiba.eu/lighting