

### MAIN FEATURES:

Symbol	Value	Unit
$I_{T(RMS)}$	4	A
$V_{DRM}/V_{RRM}$	600 and 800	V
$I_{GT}$	50 to 200	$\mu A$

### DESCRIPTION

Thanks to highly sensitive triggering levels, the X04 SCR series is suitable for all applications where the available gate current is limited, such as capacitive discharge ignitions, motor control in kitchen aids, overvoltage crowbar protection in low power supplies...

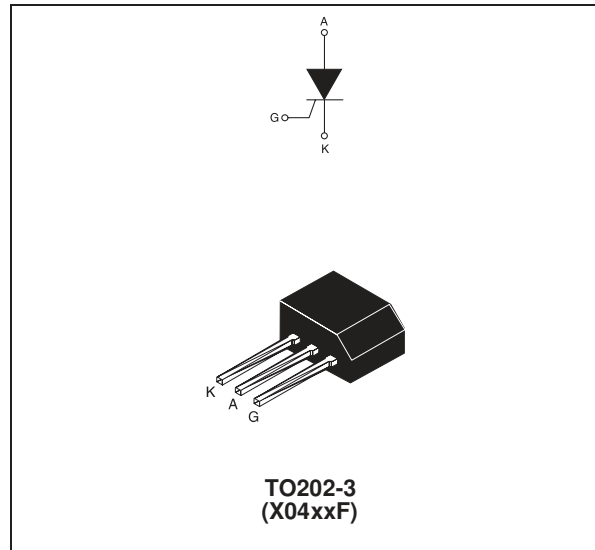

### ABSOLUTE RATINGS (limiting values)

Symbol	Parameter		Value	Unit	
$I_{T(RMS)}$	RMS on-state current (180° conduction angle)	$T_I = 60^\circ C$	4	A	
		$T_{amb} = 25^\circ C$	1.35		
$I_{T(AV)}$	Average on-state current (180° conduction angle)	$T_I = 60^\circ C$	2.5	A	
		$T_{amb} = 25^\circ C$	0.9		
$I_{TSM}$	Non repetitive surge peak on-state current	$t_p = 8.3 \text{ ms}$ $t_p = 10 \text{ ms}$	$T_j = 25^\circ C$	33	A
				30	
$I^2 t$	$I^2 t$ Value for fusing	$t_p = 10 \text{ ms}$	$T_j = 25^\circ C$	4.5	$A^2 s$
$di/dt$	Critical rate of rise of on-state current $I_G = 2 \times I_{GT}$ , $t_r \leq 100 \text{ ns}$	$F = 60 \text{ Hz}$	$T_j = 125^\circ C$	50	$A/\mu s$
$I_{GM}$	Peak gate current	$t_p = 20 \mu s$	$T_j = 125^\circ C$	1.2	A
$P_{G(AV)}$	Average gate power dissipation		$T_j = 125^\circ C$	0.2	W
$T_{sig}$ $T_j$	Storage junction temperature range Operating junction temperature range			- 40 to + 150 - 40 to + 125	$^\circ C$

## X04 Series

### ELECTRICAL CHARACTERISTICS (T<sub>j</sub> = 25°C, unless otherwise specified)

Symbol	Test Conditions		X04xx		Unit		
			02	05			
I <sub>GT</sub>	V <sub>D</sub> = 12 V    R <sub>L</sub> = 140 Ω		MIN.	—	20	μA	
			MAX.	200	50		
V <sub>GT</sub>			MAX.	0.8		V	
V <sub>GD</sub>	V <sub>D</sub> = V <sub>DRM</sub> R <sub>L</sub> = 3.3 kΩ    R <sub>GK</sub> = 1 kΩ	T <sub>j</sub> = 125°C	MIN.	0.1		V	
V <sub>RG</sub>	I <sub>RG</sub> = 10 μA		MIN.	8		V	
I <sub>H</sub>	I <sub>T</sub> = 50mA    R <sub>GK</sub> = 1kΩ		MAX.	5		mA	
I <sub>L</sub>	I <sub>G</sub> = 1mA    R <sub>GK</sub> = 1kΩ		MIN.	6		mA	
dV/dt	V <sub>D</sub> = 67% V <sub>DRM</sub> R <sub>GK</sub> = 1kΩ	T <sub>j</sub> = 110°C	MIN.	10	15	V/μs	
V <sub>TM</sub>	I <sub>TM</sub> = 8 A    tp = 380 μs	T <sub>j</sub> = 25°C	MAX.	1.8		V	
V <sub>t0</sub>	Threshold voltage		T <sub>j</sub> = 125°C	MAX.	0.95		V
R <sub>d</sub>	Dynamic resistance		T <sub>j</sub> = 125°C	MAX.	100		mΩ
I <sub>DRM</sub> I <sub>RRM</sub>	V <sub>DRM</sub> = V <sub>RRM</sub> R <sub>GK</sub> = 1 kΩ		T <sub>j</sub> = 25°C	MAX.	5		μA
			T <sub>j</sub> = 125°C		1		mA

### THERMAL RESISTANCES

Symbol	Parameter	Value	Unit
R <sub>th(j-l)</sub>	Junction to leads (DC)	15	°C/W
R <sub>th(j-a)</sub>	Junction to ambient (DC)	100	

### PRODUCT SELECTOR

Part Number	Voltage		Sensitivity	Package
	600 V	800 V		
X0402MF	X		200 μA	TO202-3
X0402NF		X	200 μA	TO202-3
X0405MF	X		50 μA	TO202-3
X0405NF		X	50 μA	TO202-3

ORDERING INFORMATION

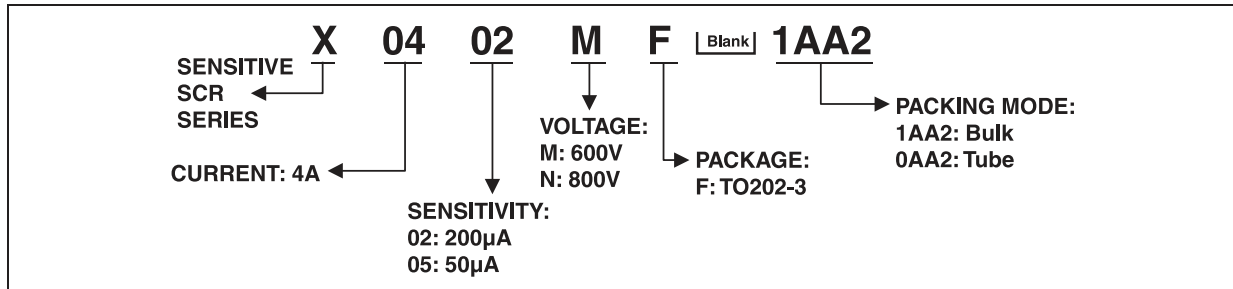

OTHER INFORMATION

Part Number	Marking	Weight	Base Quantity	Packing mode
X04xxyF 1AA2	X04xxyF	0.8 g	250	Bulk
X04xxyF 0AA2	X04xxyF	0.8 g	50	Tube

Note: xx = sensitivity, y = voltage

Fig. 1: Maximum average power dissipation versus average on-state current.

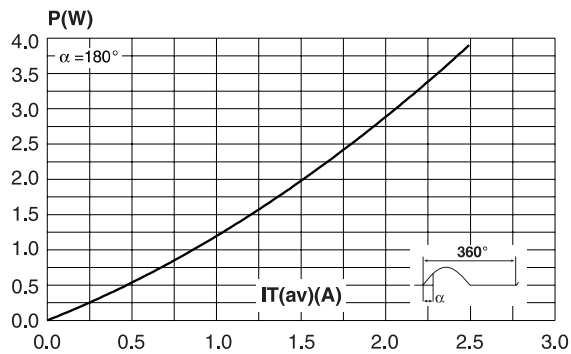

Fig. 2-1: Average and D.C. on-state current versus lead temperature.

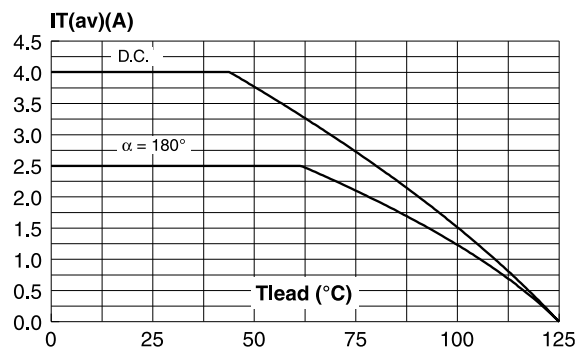

Fig. 2-2: Average and D.C. on-state current versus ambient temperature (device mounted on FR4 with recommended pad layout).

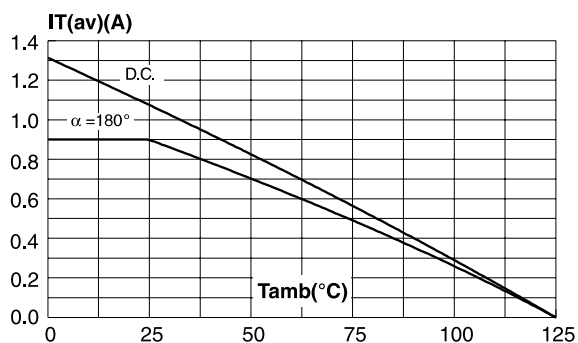
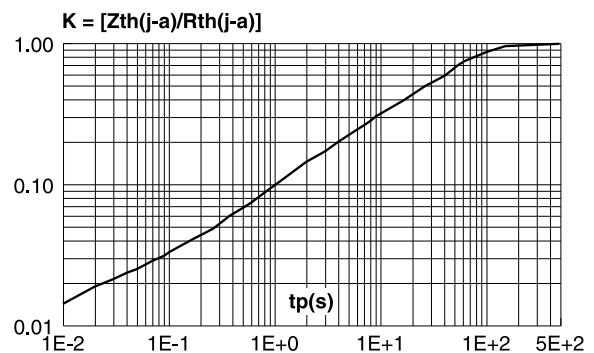
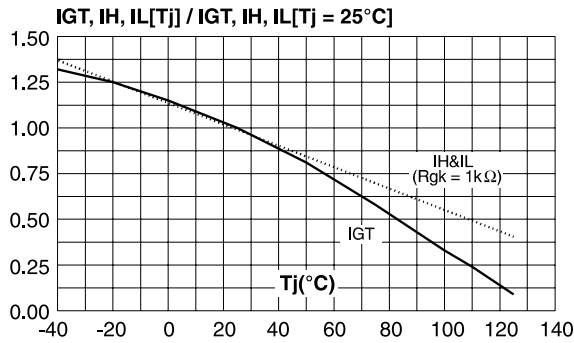

Fig. 3: Relative variation of thermal impedance junction to ambient versus pulse duration.



**Fig. 4:** Relative variation of gate trigger current, holding current and latching current versus junction temperature (typical values).



**Fig. 6:** Relative variation of dV/dt immunity versus gate-cathode resistance (typical values).

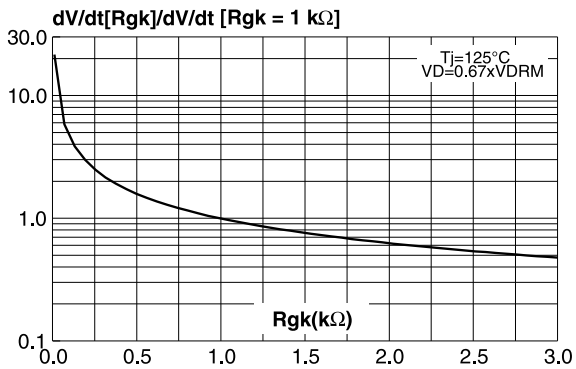

**Fig. 8:** Surge peak on-state current versus number of cycles.

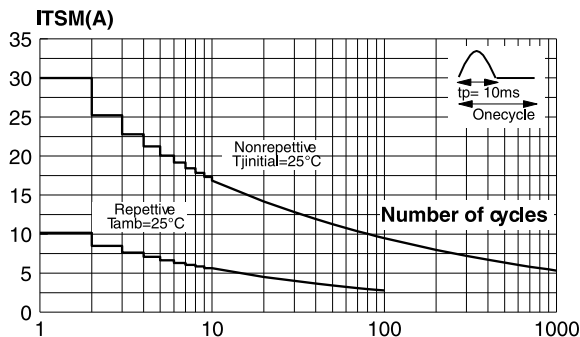

**Fig. 5:** Relative variation of holding current versus gate-cathode resistance (typical values).

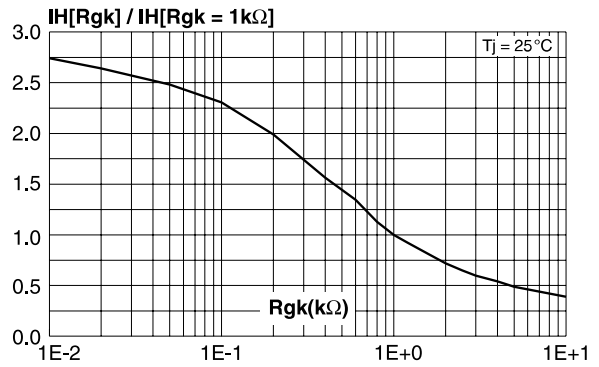

**Fig. 7:** Relative variation of dV/dt immunity versus gate-cathode capacitance (typical values).

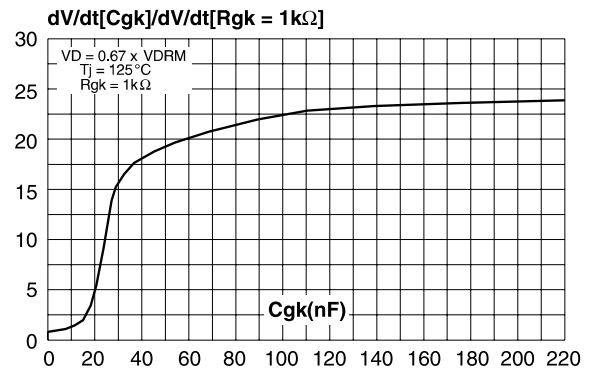

**Fig. 9:** Non-repetitive surge peak on-state current for a sinusoidal pulse with width  $t_p < 10$  ms, and corresponding value of  $I^2t$ .

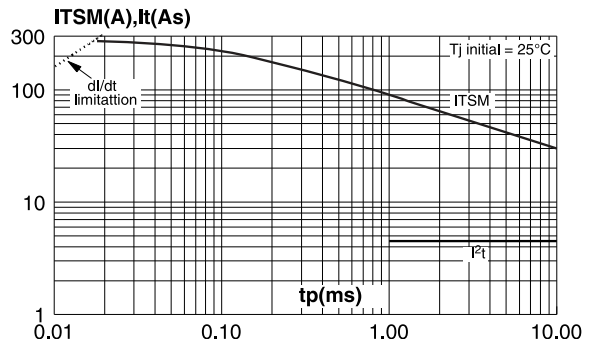
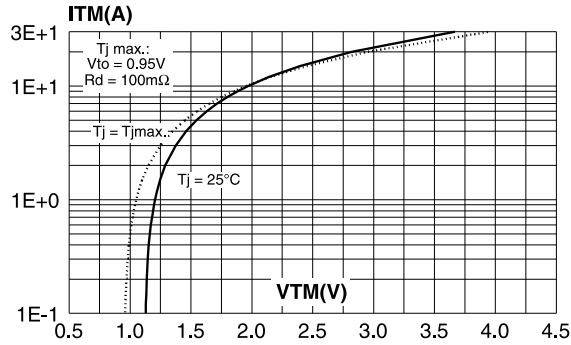
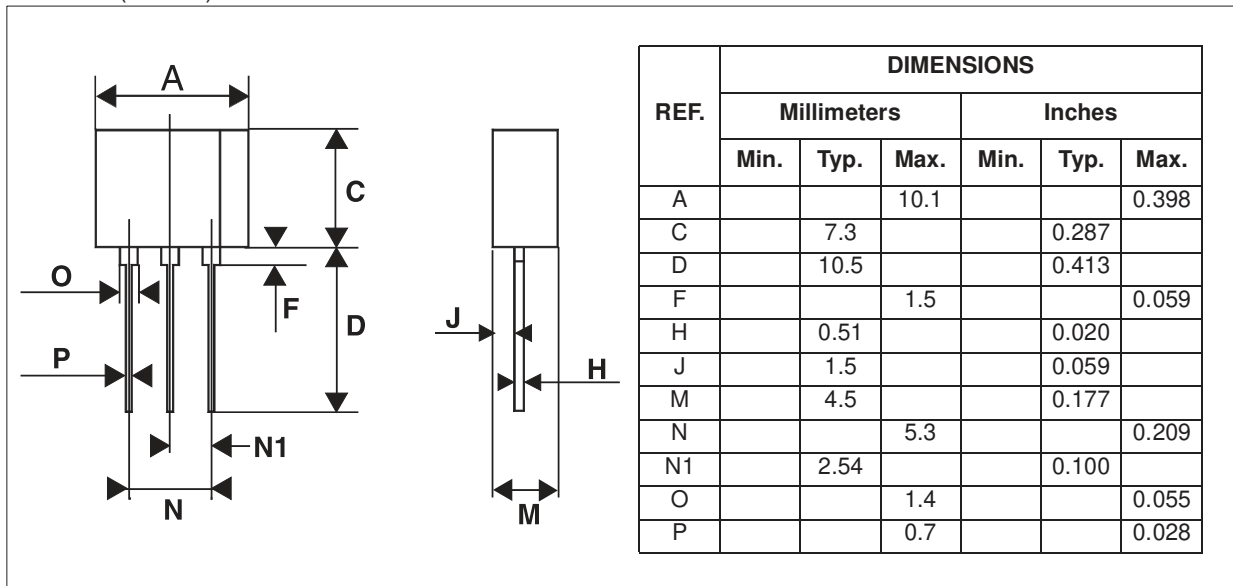

Fig. 10: On-state characteristics (maximum values).



PACKAGE MECHANICAL DATA

TO202-3 (Plastic)



Information furnished is believed to be accurate and reliable. However, STMicroelectronics assumes no responsibility for the consequences of use of such information nor for any infringement of patents or other rights of third parties which may result from its use. No license is granted by implication or otherwise under any patent or patent rights of STMicroelectronics. Specifications mentioned in this publication are subject to change without notice. This publication supersedes and replaces all information previously supplied. STMicroelectronics products are not authorized for use as critical components in life support devices or systems without express written approval of STMicroelectronics.

© The ST logo is a registered trademark of STMicroelectronics

© 2000 STMicroelectronics - Printed in Italy - All Rights Reserved

STMicroelectronics GROUP OF COMPANIES

Australia - Brazil - China - Finland - France - Germany - Hong Kong - India - Italy - Japan - Malaysia - Malta - Morocco  
Singapore - Spain - Sweden - Switzerland - United Kingdom

<http://www.st.com>

