

EG-16SR

螺帽
LOCK NUT

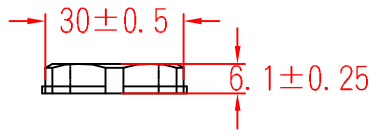

本體
BODY

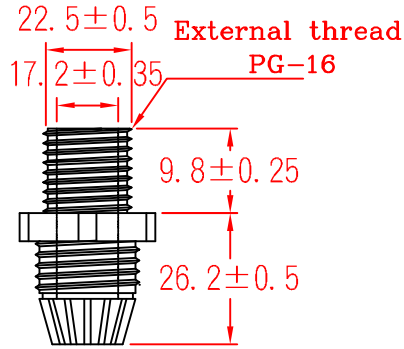

夾緊爪
CLAW

夾緊圈
SEALS

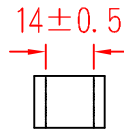

迫緊頭
NUT

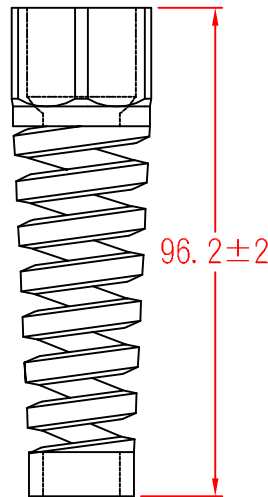

承認
KSS
98.05.19
邱平裕

審查

製圖
KSS
98.05.19
謝文通

設計

中文名
耐扭外迫式電纜固定頭

MATERIAL UL 94V-2
NYLON 66

ITEM NO.
EG-16SR

SCALE

FINISH

NAME
NYLON CABLE GLAND(WITH STRAIN RELIEF)

△ (. .)

TOLERANCE
AS FIGURE

△ 05-19-2009
DATE

REVISIONS K002

R.NO.

使用機種



凱士士企業股份有限公司

▶ 請勿實測圖面 ◀