

Draft Angle of  
Approximately 1°

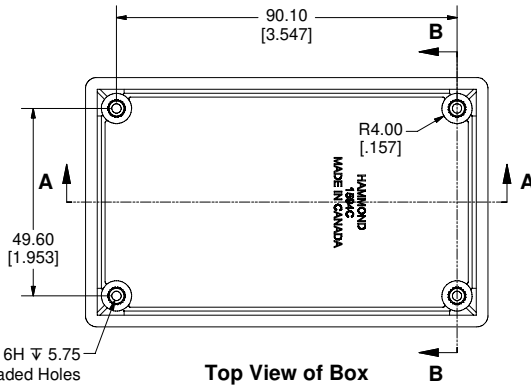

Side View of Box

M3x0.5 - 6H  $\nabla$  5.75  
Threaded Holes



Top View of Box

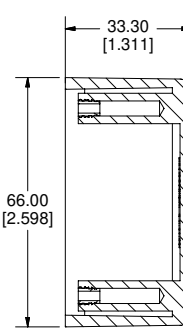

SECTION B-B  
SCALE 1 : 1

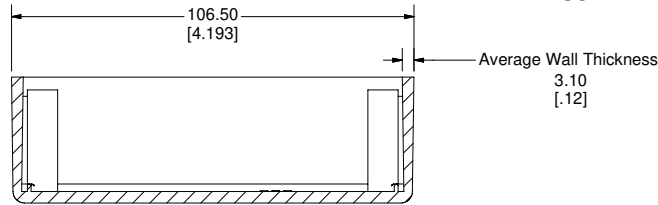

SECTION A-A  
SCALE 1 : 1

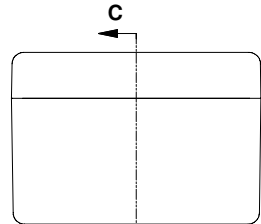

End View of Assembly

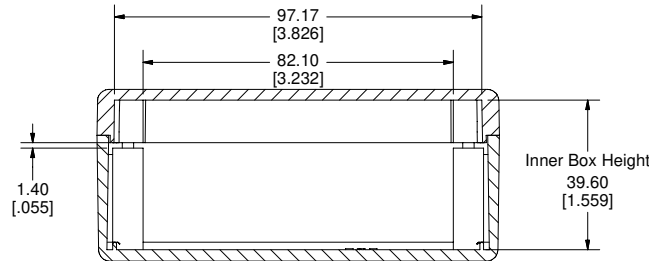

SECTION C-C  
SCALE 1 : 1

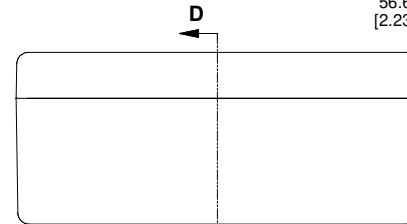

Side View of Assembly

Narrowest Inside Dimension  
56.67  
[2.231]

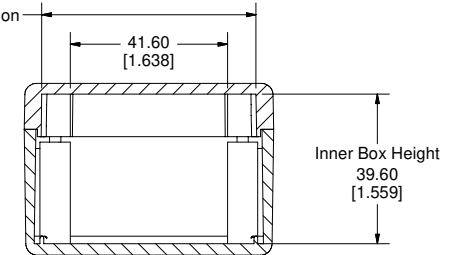

SECTION D-D  
SCALE 1 : 1

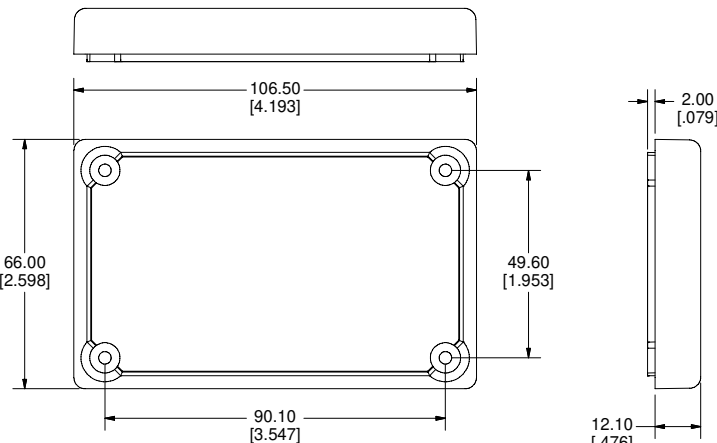

Bottom of Lid

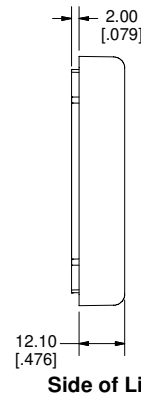

Side of Lid

1594C Enclosure	
FLAME RETARDANT ABS	
Black - RAL 9011	1594CBK
Grey - RAL 7018	1594CGY
NON-FLAME RETARDANT ABS	
Grey - RAL 7035	1594CSGY
Black - RAL 9011	1594CSBK
LIQUID RESISTANT	
Black - RAL 9011	1594CWBK
ACCESSORIES	
Cover Screws Non-Flame Retardant (pkg. 100) [#4 x 1" Self-Tapping]	1594TS100
Cover Screws Flame Retardant (pkg. 100) [M3 - 0.5 x 20mm]	1594MS100
Cover Screws Liquid Resistant (pkg. 100) [M3 - 0.5 x 20mm]	1594WMS100
Circuit Board Holders	(See 1594Z Series)

Enclosures can be Factory Modified ( Milling, Drilling, Printing etc. )  
Solid models of this enclosure available in STEP or IGES.  
Contact Factory [mjm@hammondmfg.com](mailto:mjm@hammondmfg.com)

