

## CRLCBSR Series

### Cupped Reverse Locking Circuit Board Support, Round Hole

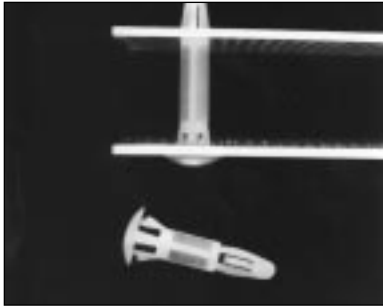

TO SNAP-LOCK IN A  $.157 \pm .003$  ( $4.0 \pm 0.08$ ) DIA. HOLE, IN A  $.063$  (1.6) NOMINAL THICK BOARD

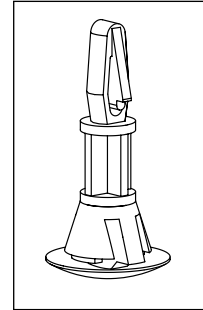
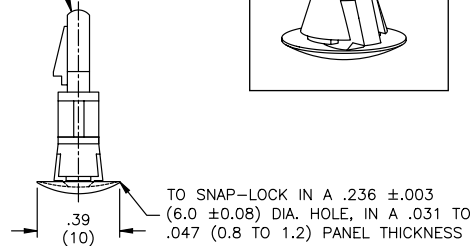
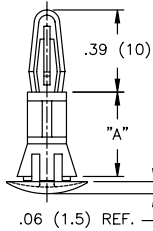

Material: Nylon 6/ 6, RMS-01  
Color: Natural

Part No.	Standard Pack:
	1000 per bag "A" $\pm .015$ (0.4)
CRLCBSR-3-01	3/16 (4.8)
CRLCBSR-4-01	1/4 (6.4)
CRLCBSR-5-01	5/16 (7.9)
CRLCBSR-6-01	3/8 (9.5)
CRLCBSR-8-01	1/2 (12.7)
CRLCBSR-12-01	3/4 (19.1)

Part available in V-0 material by special order. To order, replace -01 with -19.

Part available in black by special order. To order, use part number CRLCBSR-XX-XX-B.

#### Features

- Cupped head provides tight holding in a chassis with a wide tolerance

A

## CRLCBSRE Series

### Cupped Reverse Lock Circuit Board Support, Round Hole



TO SNAP-LOCK IN A  $.157 \pm .003$  ( $4.0 \pm 0.08$ ) DIA. HOLE, IN A  $.063$  (1.6) NOMINAL THICK BOARD

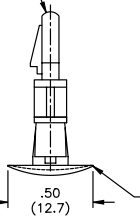
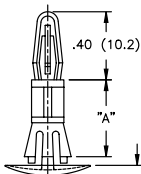

Material: Nylon 6/ 6, RMS-01  
Color: Natural

Part No.	Standard Pack:
	1000 per bag "A" $\pm .015$ (0.4)
CRLCBSRE-4-01	1/4 (6.4)
CRLCBSRE-6-01	3/8 (9.5)
CRLCBSRE-8-01	1/2 (12.7)
CRLCBSRE-10-01	5/8 (15.9)

Part available in V-0 material by special order. To order, replace -01 with -19.

Part available in black by special order. To order, use part number CRLCBSRE-XX-XX-B.

## RLCBSK/RLCBSK2 Series

### Reverse Locking Circuit Board Support, Pronged Round Hole - Metric

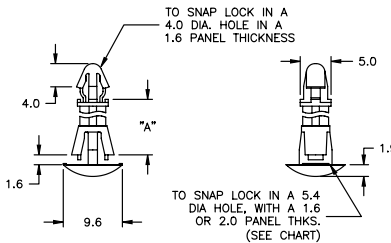

TO SNAP LOCK IN A 4.0 DIA. HOLE IN A 1.6 PANEL THICKNESS

TO SNAP LOCK IN A 5.4 DIA. HOLE, WITH A 1.6 OR 2.0 PANEL THICKS. (SEE CHART)

Material: Nylon 6/ 6, RMS-01  
Color: Natural

Part No.	Standard Pack:
	1000 per bag "A" $\pm 0.4$ mm
Panel 1.6 mm	"A" $\pm 0.4$ mm
RLCBSK-6-01	6.0 mm
RLCBSK-8-01	8.0 mm
RLCBSK-10-01	10.0 mm
RLCBSK-12-01	12.0 mm
Panel 2.0 mm	"A" $\pm 0.4$ mm
RLCBSK-2-6-01	6.0 mm
RLCBSK-2-8-01	8.0 mm
RLCBSK-2-10-01	10.0 mm
RLCBSK-2-12-01	12.0 mm

## CRLCBSK-2 Series

### Cupped Reverse Locking Circuit Board Support Metric

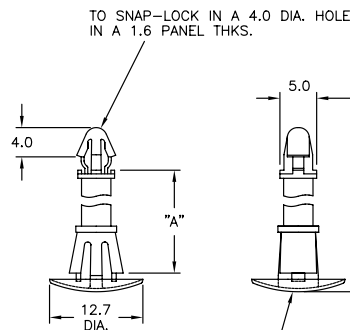

TO SNAP-LOCK IN A 4.0 DIA. HOLE IN A 1.6 PANEL THKS.

TO SNAP LOCK INTO A  $\phi 5.40 \pm 0.075$  mm HOLE IN A 1.0 mm TO 1.6 mm THICK CHASSIS

Material: Nylon 6/ 6, RMS-01  
Color: Natural

Part No.	Standard Pack:
	1000 per bag "A" $\pm 0.4$ mm
CRLCBSK-2-8-01	8 mm
CRLCBSK-2-10-01	10 mm
CRLCBSK-2-12-01	12 mm
CRLCBSK-2-14-01	14 mm

Part available in V-0 material by special order. To order, replace -01 with -19.

## RLCBSRS Series

### Reverse Locking Circuit Board Support, Round Hole Standoff

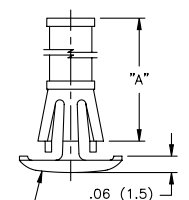
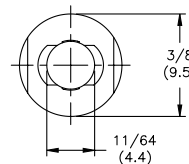

TO SNAP-LOCK IN A  $.187 \pm .003$  ( $4.75 \pm 0.08$ ) DIA. HOLE, IN A  $.059$  (1.50) TO  $.063$  (1.60) THICK PANEL/CHASSIS

Material: Nylon 6/ 6, RMS-01  
Color: Natural

Part No.	Standard Pack:
	1000 per bag "A" $\pm .015$ (0.4)
RLCBSRS-4-01	1/4 (6.4)
RLCBSRS-5-01	5/16 (7.9)
RLCBSRS-6-01	3/8 (9.5)
RLCBSRS-7-01	7/16 (11.1)
RLCBSRS-8-01	1/2 (12.7)
RLCBSRS-9-01	9/16 (14.3)
RLCBSRS-10-01	5/8 (15.9)

Part available in V-0 material by special order. To order, replace -01 with -19.

#### Features

- Supports heavy loaded PC boards; often used with Richco RLCBSR Series