

HP-15

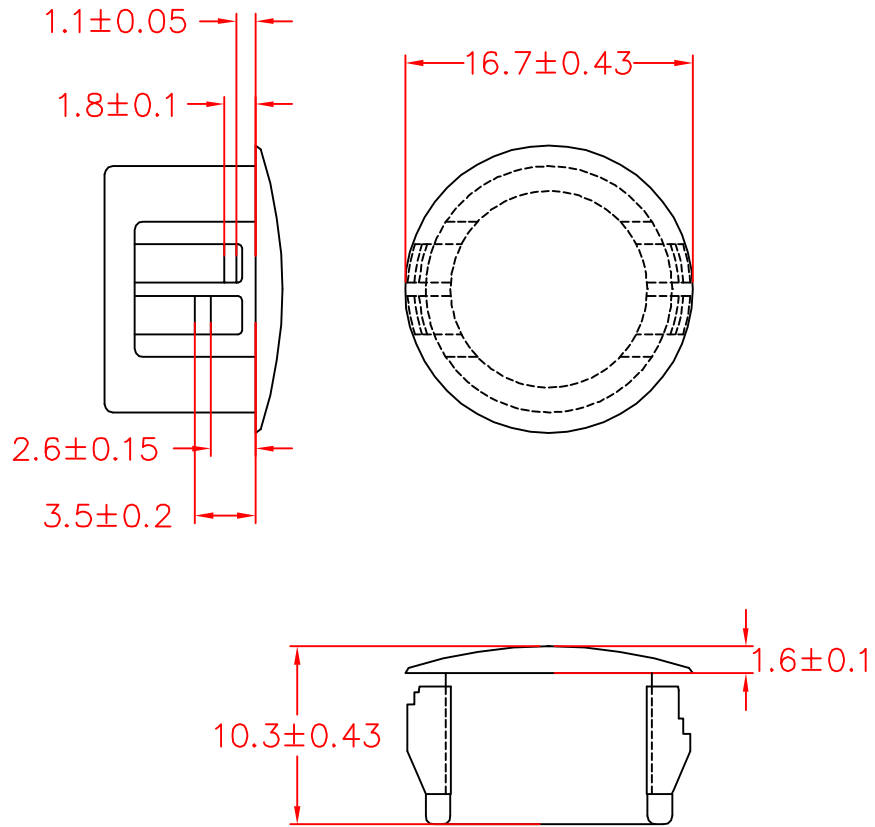

To fit 14.3 ± 0.1 mm hole
Max. Thickness 3.2mm

承認



審查

製圖



設計

中文名		MATERIAL	UL 94V-2	I TEM NO.
扣式塞頭			NYLON 66	HP-15
SCALE	mm	FINISH	NAME	
			HOLE PLUG	
△ ()	TOLERANCE	△ ()	04-21-2008	REVISIONS
使用機種	AS FIGURE	DATE	K001	R.NO.

