

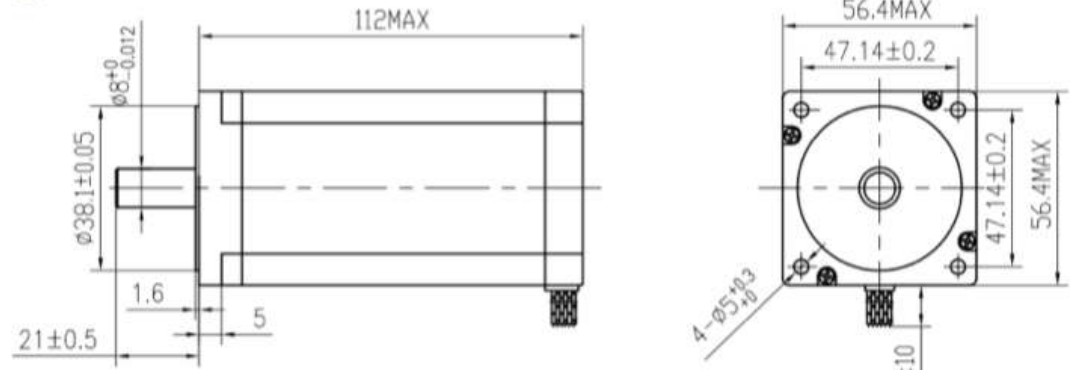

Spezifikationen / Specifications

Phase	2 Phase
Step Angle / Schrittwinkel	1.8° ± 5% / Step
Voltage / Nennspannung	4.8 V
Current / Nennstrom	3.0 A/Phase
Resistance / Widerstand	1.6 ± 10% Ω/Phase
Inductance / Induktanz	6.8 ± 20% mH/Phase
Holding Torque / Haltemoment	280 N.cm Min
Detent Torque / Rastmoment	12 N.cm Max
Insulation Class / Isolierungs Klasse	B
Lead Style / Kabel Art	AWG22 UL1007
Rotor Torque / Rotorträgheit	800 g.cm ²

Mechanische Abmessungen / Mechanical Dimensions



Verbindungen / Connections

Drehmomentkurve / Torque Curve

