

# R60 Series, Radial, 10 – 37.5 mm Lead Spacing, 50 – 1,000 VDC (Automotive Grade)

## Overview

The R60 Series is constructed of metallized polyester film (wound or stacked technology) with radial leads of tinned wire. Radial leads are electrically welded to the contact metal layer on the ends of the capacitor winding. The capacitor is encapsulated in a self-extinguishing solvent resistant plastic case with thermosetting resin material meeting the UL 94V-0 requirements.

Automotive Grade devices are available (up to lead spacing 22.5 mm) and meet the demanding Automotive Electronics Council's AEC-Q200 qualification requirements.

## Applications

Typical applications include blocking, coupling, decoupling, bypassing and interference suppression in low voltage applications such as automotive. Not suitable for across-the-line application (see Suppressor Capacitors).

## Benefits

- Voltage range: 50 – 1000 VDC
- Capacitance range: 0.001  $\mu$ F – 220.0  $\mu$ F
- Lead spacing: 10.0 – 37.5 mm
- Capacitance tolerance:  $\pm$ 5%,  $\pm$ 10%,  $\pm$ 20%
- Climatic category: 55/105/56
- Operating temperature range of -55°C to +105°C
- RoHS compliance and lead-free terminations
- Tape and reel packaging in accordance with IEC 60286-2
- Self-healing
- Automotive (AEC-Q200) grades available up to pitch 22.5 mm

## Part Number System

R60	M	F	2470	AA	60	K
Series	Rated Voltage (VDC)	Length (mm)	Capacitance Code (pF)	Lead and Packaging Code	Internal Use	Capacitance Tolerance
Metallized Polyester	C = 50 D = 63 E = 100 G = 160 I = 250 M = 400 P = 630 Q = 1000	F = 10 I = 15 N = 22.5 R = 27.5 W = 37.5	Digits 2-4 indicate the first three digits of the capacitance value. First digit indicates the number of zeros to be added.	See Ordering Options Table	00 01 30 40 50 6A L0 L1	J = $\pm$ 5% K = $\pm$ 10% M = $\pm$ 20%

## Ordering Options Table

Lead Spacing Nominal (mm)	Type of Leads and Packaging	LL Lead Length (mm)	Lead and Packaging Code
10 15 22.5	<b>Standard Lead and Packaging Options</b>		
	Bulk (Bag) – Short Leads	4 +2/-0	AA
	Ammo Pack	$H_0=18.5 \pm 0.5$	DQ
	<b>Other Lead and Packaging Options</b>		
	Tape & Reel (Standard Reel)	$H_0 = 18.5 \pm 0.5$	GY
	Tape & Reel (Large Reel)	$H_0=18.5 \pm 0.5$	CK
	Bulk (Bag) – Short Leads	2.7 +0.5/-0	JA
	Bulk (Bag) – Short Leads	3.5 +0.5/-0	JB
	Bulk (Bag) – Short Leads	10 +/- 1	JC
	Bulk (Bag) – Short Leads	4.0 +0.5/-0	JE
	Bulk (Bag) – Short Leads	3.2 +0.3/-0.2	JH
	Bulk (Bag) – Long Leads	18 +1/-1	JM*
	Bulk (Bag) – Long Leads	17 +1/-2	Z3**
	Bulk (Bag) – Long Leads	30 +5/-0	40
Bulk (Bag) – Long Leads	25 +2/-1	50	
27.5	<b>Standard Lead and Packaging Options</b>		
	Bulk (Bag) – Short Leads	4 +2/-0	AA
	<b>Other Lead and Packaging Options</b>		
	T&R (Large Reel)	$H_0=18.5 \pm 0.5$	CK
	Bulk (Bag) – Short Leads	2.7 +0.5/-0	JA
	Bulk (Bag) – Short Leads	3.5 +0.5/-0	JB
	Bulk (Bag) – Short Leads	4.0 +0.5/-0	JE
	Bulk (Bag) – Short Leads	3.2 +0.3/-0.2	JH
	Bulk (Bag) – Long Leads	18 +1/-1	JM
	Bulk (Bag) – Long Leads	30 +5/-0	40
Bulk (Bag) – Long Leads	25 +2/-1	50	
37.5	<b>Standard Lead and Packaging Options</b>		
	Bulk (Bag) – Short Leads	4 +2/-0	AA
	<b>Other Lead and Packaging Options</b>		
	Bulk (Bag) – Short Leads	2.7 +0.5/-0	JA
	Bulk (Bag) – Short Leads	3.5 +0.5/-0	JB
	Bulk (Bag) – Short Leads	4.0 +0.5/-0	JE
	Bulk (Bag) – Short Leads	3.2 +0.3/-0.2	JH
	Bulk (Bag) – Long Leads	18 +1/-1	JM
	Bulk (Bag) – Long Leads	30 +5/-0	40
	Bulk (Bag) – Long Leads	25 +2/-1	50

\* Only available for Lead Spacing  $\geq 15$  mm.

\*\* Only available for 10 mm Lead Spacing.

## Dimensions – Millimeters

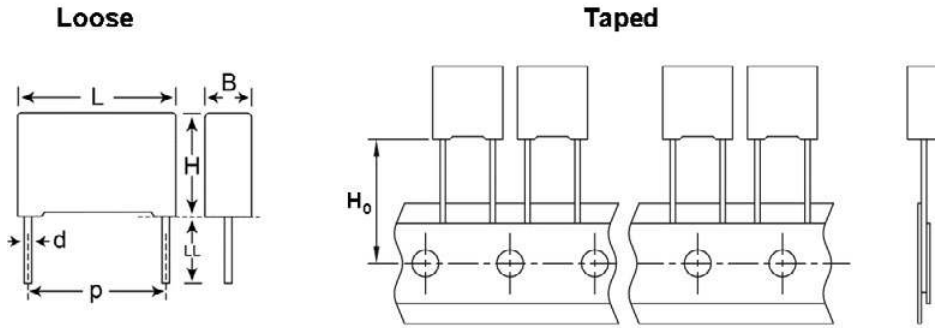

p		B		H		L		d	
Nominal	Tolerance	Nominal	Tolerance	Nominal	Tolerance	Nominal	Tolerance	Nominal	Tolerance
10.0	+/- 0.4	4.0	+0.2	9.0	+0.1	13.0	+0.2	0.6	+/- 0.05
10.0	+/- 0.4	5.0	+0.2	11.0	+0.1	13.0	+0.2	0.6	+/- 0.05
10.0	+/- 0.4	6.0	+0.2	12.0	+0.1	13.0	+0.2	0.6	+/- 0.05
15.0	+/- 0.4	5.0	+0.2	11.0	+0.1	18.0	+0.3	0.8	+/- 0.05
15.0	+/- 0.4	6.0	+0.2	12.0	+0.1	18.0	+0.3	0.8	+/- 0.05
15.0	+/- 0.4	7.5	+0.2	13.5	+0.1	18.0	+0.5	0.8	+/- 0.05
15.0	+/- 0.4	8.5	+0.2	14.5	+0.1	18.0	+0.5	0.8	+/- 0.05
15.0	+/- 0.4	9.0	+0.2	12.5	+0.1	18.0	+0.5	0.8	+/- 0.05
15.0	+/- 0.4	10.0	+0.2	16.0	+0.1	18.0	+0.5	0.8	+/- 0.05
15.0	+/- 0.4	11.0	+0.2	19.0	+0.1	18.0	+0.5	0.8	+/- 0.05
15.0	+/- 0.4	13.0	+0.2	12.0	+0.1	18.0	+0.5	0.8	+/- 0.05
22.5	+/- 0.4	6.0	+0.2	15.0	+0.1	26.5	+0.3	0.8	+/- 0.05
22.5	+/- 0.4	7.0	+0.2	16.0	+0.1	26.5	+0.3	0.8	+/- 0.05
22.5	+/- 0.4	8.5	+0.2	17.0	+0.1	26.5	+0.3	0.8	+/- 0.05
22.5	+/- 0.4	10.0	+0.2	18.5	+0.1	26.5	+0.3	0.8	+/- 0.05
22.5	+/- 0.4	11.0	+0.2	20.0	+0.1	26.5	+0.3	0.8	+/- 0.05
22.5	+/- 0.4	13.0	+0.2	22.0	+0.1	26.5	+0.3	0.8	+/- 0.05
27.5	+/- 0.4	9.0	+0.2	17.0	+0.1	32.0	+0.3	0.8	+/- 0.05
27.5	+/- 0.4	11.0	+0.2	20.0	+0.1	32.0	+0.3	0.8	+/- 0.05
27.5	+/- 0.4	13.0	+0.2	22.0	+0.1	32.0	+0.3	0.8	+/- 0.05
27.5	+/- 0.4	14.0	+0.2	28.0	+0.1	32.0	+0.3	0.8	+/- 0.05
27.5	+/- 0.4	18.0	+0.2	33.0	+0.1	32.0	+0.3	0.8	+/- 0.05
27.5	+/- 0.4	22.0	+0.2	37.0	+0.1	32.0	+0.3	0.8	+/- 0.05
37.5	+/- 0.4	11.0	+0.3	22.0	+0.1	41.5	+0.3	1.0	+/- 0.05
37.5	+/- 0.4	13.0	+0.3	24.0	+0.1	41.5	+0.3	1.0	+/- 0.05
37.5	+/- 0.4	16.0	+0.3	28.5	+0.1	41.5	+0.3	1.0	+/- 0.05
37.5	+/- 0.4	19.0	+0.3	32.0	+0.1	41.5	+0.3	1.0	+/- 0.05
37.5	+/- 0.4	20.0	+0.3	40.0	+0.1	41.5	+0.3	1.0	+/- 0.05
37.5	+/- 0.4	24.0	+0.3	44.0	+0.1	41.5	+0.3	1.0	+/- 0.05
37.5	+/- 0.4	30.0	+0.3	45.0	+0.1	41.5	+0.3	1.0	+/- 0.05

Note: See Ordering Options Table for lead length (LL/H<sub>0</sub>) options.

## Performance Characteristics

Dielectric	Polyester film (polyethylene terephthalate).							
Plates	Metal layer deposited by evaporation under vacuum.							
Winding	Non-inductive type.							
Leads	Tinned wire.							
Protection	Plastic case, thermosetting resin filled. Box material is solvent resistant and flame retardant according to UL94.							
Related Documents	IEC 60384-2							
Rated Voltage $V_R$ (VDC)	50	63	100	160	250	400	630	1000
Rated Voltage $V_R$ (VAC)	30	40	63	90	160	200	220	250
Capacitance Range ( $\mu\text{F}$ )	1.5 – 5.6	0.68 – 220	0.33 – 150	0.22 – 150	0.1 – 68	0.015 – 33	0.0047 – 10	0.001 – 4.7
Capacitance Values	E6 series (IEC 60063) measured @ 1 kHz and +20 $\pm$ 1°C							
Capacitance Tolerance	$\pm$ 5%, $\pm$ 10%, $\pm$ 20%							
Operating Temperature Range	-55°C to +105°C Upper operating temperature of +125°C is allowed for a maximum operating time of 1,000 hours.							
Rated Temperature $T_R$	+85°C							
Voltage Derating	Above +85°C DC and AC voltage derating is 1.25%/°C							
Climatic Category	55/105/56 IEC 60068-1							
	Average relative humidity $\leq$ 75%							
	RH = 95% for 30 days per year							
	RH = 85% for further days limited by average value per year							
Test Voltage	1.6 x $V_R$ VDC for 2 seconds (between terminations) @ +25°C $\pm$ 5°C							
Capacitance Drift	Maximum 3% after a 2 year storage period at a temperature of +10°C to +40°C and a relative humidity of 40% to 60%							
Reliability (Reference MIL-HDBK-217)	Operational life >200,000 hours							
	Failure rate $\leq$ 5 FIT, T = +40°C, V = 0.5 x $V_R$							
	Failure criteria: open or short circuit, cap. change > 10%, DF 2 times the catalog limits, IR < 0.005 x initial limit							
Maximum Pulse Steepness	dV/dt according to Table 1. For peak to peak voltages lower than rated voltage ( $V_{pp} < V_R$ ), the specified dv/dt can be multiplied by the factor $V_R/V_{pp}$							
Temperature Coefficient	+400 ( $\pm$ 200)ppm/°C at 1 kHz							
Self Inductance (Lead Length ~ 2 mm)	Lead Spacing (mm)	10	15	22.5	27.5	37.5		
	L (nH)	9	10	18	18	22		
	Maximum 1 nH per 1 mm lead and capacitor length.							

## Performance Characteristics cont'd

Dissipation Factor $\tan\delta$	Maximum Values @ 25°C ±5°C		
	Frequency	C ≤ 1 μF	C > 1 μF
	1 kHz	1.00%	1.00%
10 kHz	1.50%	–	

Insulation Resistance	Measured @ +25°C ±5°C, according to IEC 60384–2		
	Minimum Values Between Terminals		
	Voltage Charge/Time	C ≤ 0.33 μF	C > 0.33 μF
	50 VDC for $V_R \leq 100$ VDC 1 minute	≥ 3,750 MΩ ( ≥ 50,000 MΩ ) *	≥ 1,250 MΩ • μF ( ≥ 5,000 MΩ • μF ) *
100 VDC for $V_R > 100$ VDC 1 minute	≥ 30,000 MΩ ( ≥ 50,000 MΩ ) *	≥ 10,000 MΩ • μF ( ≥ 17,000 MΩ • μF ) *	

\* typical value

## Qualification

Automotive Grade products meet or exceed the requirements outlined by the Automotive Electronics Council. Details regarding test methods and conditions are referenced in document AEC–Q200, Stress Test Qualification for Passive Components. For additional information regarding the Automotive Electronics Council and AEC–Q200, please visit their website at [www.aecouncil.com](http://www.aecouncil.com).

## Maximum Voltage ( $V_{rms}$ ) vs. Frequency (Sinusoidal Waveform/ $T_h \leq 40^\circ C$ )

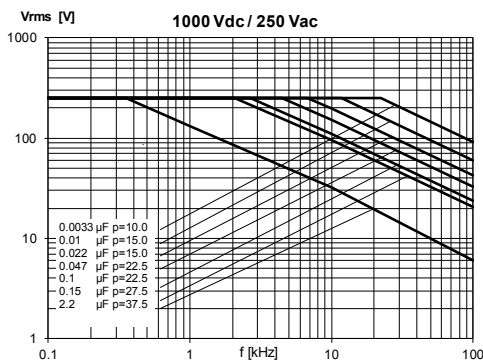
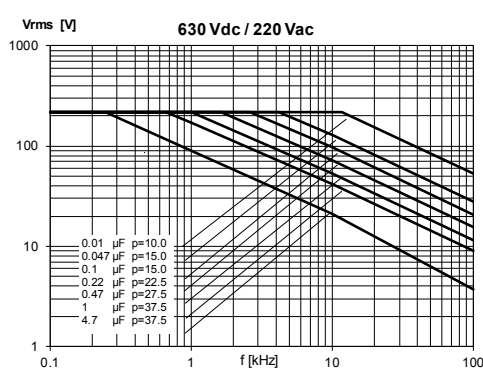
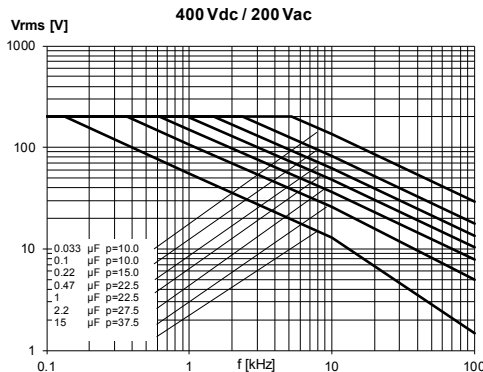
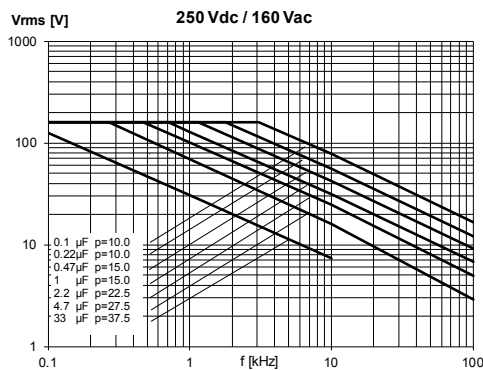
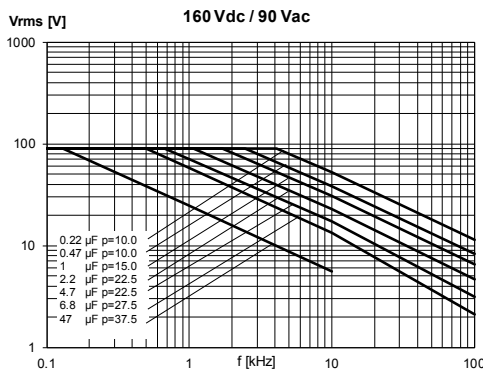
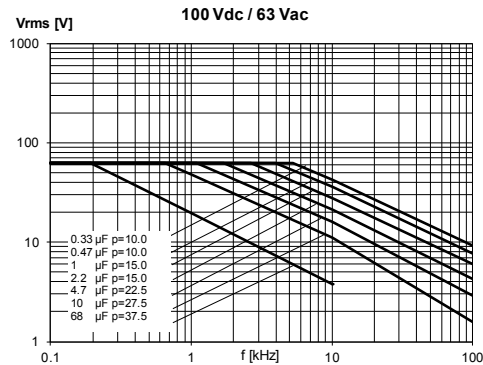
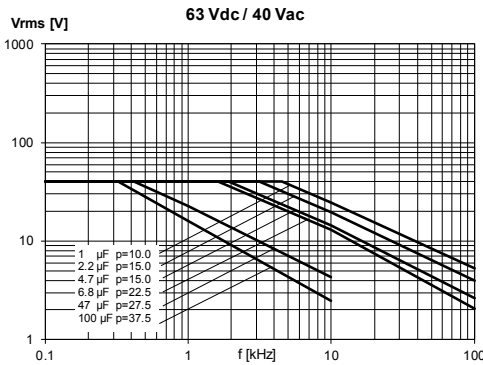

## Maximum Current ( $I_{rms}$ ) vs. Frequency (Sinusoidal Waveform/ $Th \leq 40^\circ C$ )

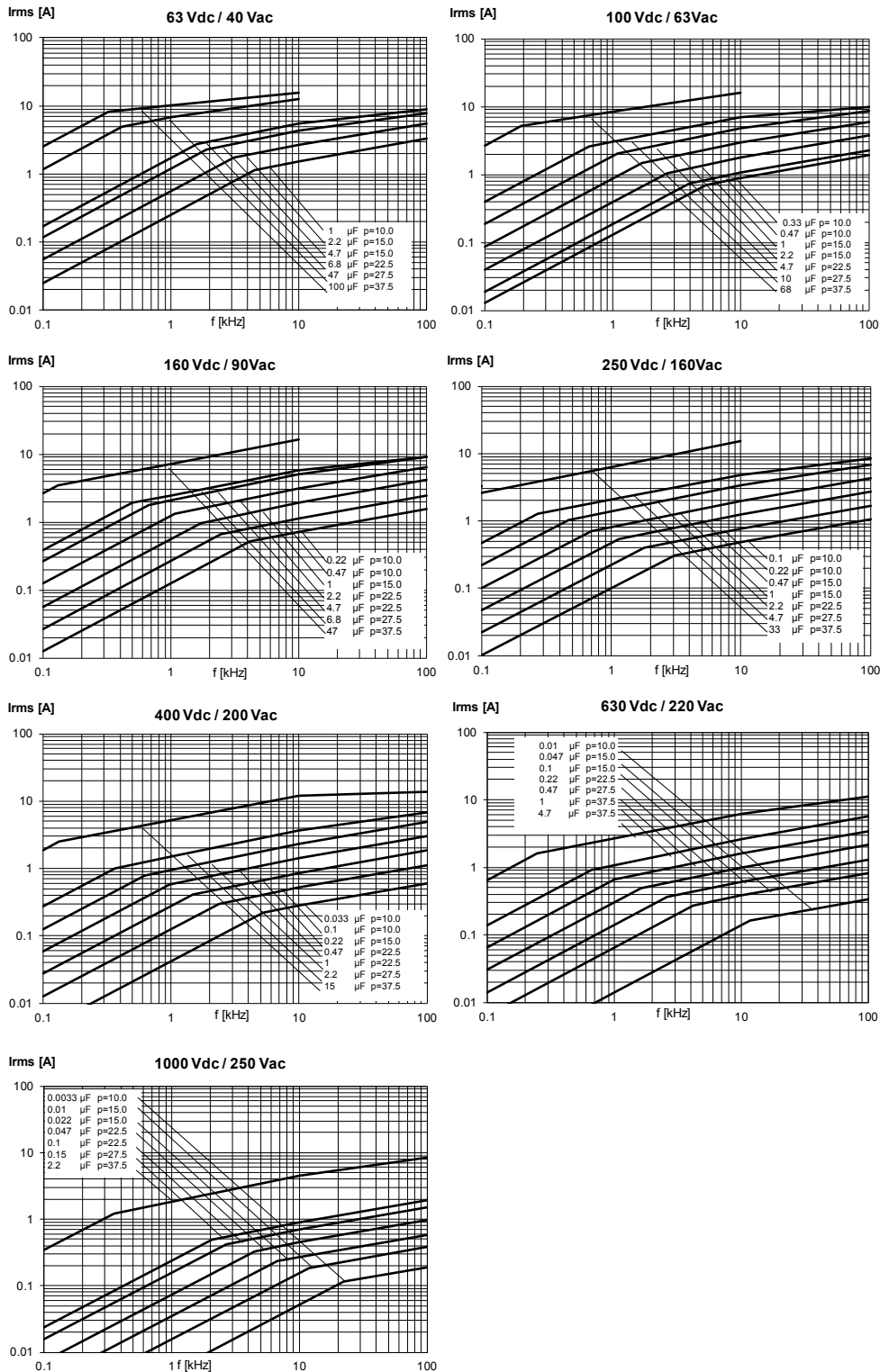

## Environmental Test Data

Damp Heat, Steady State Test	Test Conditions:		Performances
	Temperature: Relative humidity (RH): Test duration:	+40°C ±2°C 93% ±2% 56 days	Δ C/C  ≤ 5%, Δ tanδ ≤ 0.005 @ 1 kHz IR after test ≥ 50% of initial limit
Endurance Test	Test Conditions		Performances
	Temperature: Voltage applied: Test duration:	+105°C ±2°C 1.25 x V <sub>C</sub> 2,000 hours	Δ C/C  ≤ 5%, Δ tanδ ≤ 0.005 @10 kHz for C ≤ 1μF Δ tanδ ≤ 0.003 @ 1 kHz for C > 1μF IR after test ≥ 50% of initial limit
Resistance to Soldering Heat Test	Test Conditions		Performances
	Solder bath temperature: Dipping time (with heat screen):	260°C ±5°C 10 seconds ±1 second	Δ C/C  ≤ 2%, Δ tanδ ≤ 0.005 @10 kHz for C ≤ 1μF Δ tanδ ≤ 0.003 @ 1 kHz for C > 1μF IR after test ≥ initial limit

## Environmental Compliance

All KEMET MKT capacitors are RoHS Compliant.



RoHS Compliant



**Table 1A – Ratings & Part Number Reference (Stacked Capacitor Technology)**

VDC	VAC	Capacitance Value (µF)	Dimensions in mm			Lead Spacing	dV/dt (V/µs)	Maximum K <sub>0</sub> (V <sup>2</sup> /µs)	New KEMET Part Number	Legacy Part Number
			B	H	L					
50	30	1.5	4.0	9.0	13.0	10.0	30	3000	60CF4150(1)6A(2)	R60CF4150(1)6A(2)
50	30	2.2	4.0	9.0	13.0	10.0	30	3000	60CF4220(1)6A(2)	R60CF4220(1)6A(2)
50	30	3.3	5.0	11.0	13.0	10.0	30	3000	60CF4330(1)6A(2)	R60CF4330(1)6A(2)
50	30	4.7	6.0	12.0	13.0	10.0	30	3000	60CF4470(1)6A(2)	R60CF4470(1)6A(2)
50	30	5.6	6.0	12.0	13.0	10.0	30	3000	60CF4560(1)6A(2)	R60CF4560(1)6A(2)
63	40	1.0	4.0	9.0	13.0	10.0	50	6300	60DF4100(1)6A(2)	R60DF4100(1)6A(2)
63	40	1.5	5.0	11.0	13.0	10.0	50	6300	60DF4150(1)6A(2)	R60DF4150(1)6A(2)
63	40	2.2	5.0	11.0	13.0	10.0	50	6300	60DF4220(1)6A(2)	R60DF4220(1)6A(2)
63	40	3.3	6.0	12.0	13.0	10.0	50	6300	60DF4330(1)6A(2)	R60DF4330(1)6A(2)
100	63	0.33	4.0	9.0	13.0	10.0	75	15000	60EF3330(1)6A(2)	R60EF3330(1)6A(2)
100	63	0.47	4.0	9.0	13.0	10.0	75	15000	60EF3470(1)6A(2)	R60EF3470(1)6A(2)
100	63	0.68	4.0	9.0	13.0	10.0	75	15000	60EF3680(1)6A(2)	R60EF3680(1)6A(2)
100	63	1.0	5.0	11.0	13.0	10.0	75	15000	60EF4100(1)6A(2)	R60EF4100(1)6A(2)
100	63	1.5	5.0	11.0	13.0	10.0	75	15000	60EF4150(1)6A(2)	R60EF4150(1)6A(2)
160	90	0.22	4.0	9.0	13.0	10.0	100	32000	60GF3220(1)6A(2)	R60GF3220(1)6A(2)
160	90	0.33	4.0	9.0	13.0	10.0	100	32000	60GF3330(1)6A(2)	R60GF3330(1)6A(2)
160	90	0.47	5.0	11.0	13.0	10.0	100	32000	60GF3470(1)6A(2)	R60GF3470(1)6A(2)
160	90	0.68	6.0	12.0	13.0	10.0	100	32000	60GF3680(1)6A(2)	R60GF3680(1)6A(2)
250	160	0.10	4.0	9.0	13.0	10.0	150	75000	60IF3100(1)6A(2)	R60IF3100(1)6A(2)
250	160	0.15	4.0	9.0	13.0	10.0	150	75000	60IF3150(1)6A(2)	R60IF3150(1)6A(2)
250	160	0.22	5.0	11.0	13.0	10.0	150	75000	60IF3220(1)6A(2)	R60IF3220(1)6A(2)
250	160	0.33	5.0	11.0	13.0	10.0	150	75000	60IF3330(1)6A(2)	R60IF3330(1)6A(2)
250	160	0.47	6.0	12.0	13.0	10.0	150	75000	60IF3470(1)6A(2)	R60IF3470(1)6A(2)
400	200	0.033	4.0	9.0	13.0	10.0	175	140000	60MF2330(1)6A(2)	R60MF2330(1)6A(2)
400	200	0.047	4.0	9.0	13.0	10.0	175	140000	60MF2470(1)6A(2)	R60MF2470(1)6A(2)
400	200	0.068	4.0	9.0	13.0	10.0	175	140000	60MF2680(1)6A(2)	R60MF2680(1)6A(2)
400	200	0.10	5.0	11.0	13.0	10.0	175	140000	60MF3100(1)6A(2)	R60MF3100(1)6A(2)
400	200	0.15	6.0	12.0	13.0	10.0	175	140000	60MF3150(1)6A(2)	R60MF3150(1)6A(2)
630	220	0.010	4.0	9.0	13.0	10.0	200	252000	60PF2100(1)6A(2)	R60PF2100(1)6A(2)
630	220	0.015	4.0	9.0	13.0	10.0	200	252000	60PF2150(1)6A(2)	R60PF2150(1)6A(2)
630	220	0.022	4.0	9.0	13.0	10.0	200	252000	60PF2220(1)6A(2)	R60PF2220(1)6A(2)
630	220	0.033	5.0	11.0	13.0	10.0	200	252000	60PF2330(1)6A(2)	R60PF2330(1)6A(2)
630	220	0.047	5.0	11.0	13.0	10.0	200	252000	60PF2470(1)6A(2)	R60PF2470(1)6A(2)
VDC	VAC	Capacitance Value (µF)	B (mm)	H (mm)	L (mm)	Lead Spacing	dV/dt (V/µs)	Max K <sub>0</sub> (V <sup>2</sup> /µs)	New KEMET Part Number	Legacy Part Number

**Table 1B – Ratings & Part Number Reference (Wound Capacitor Technology)**

VDC	VAC	Capacitance Value (µF)	Dimensions in mm			Lead Spacing	dV/dt (V/µs)	Maximum K <sub>0</sub> (V <sup>2</sup> /µs)	New KEMET Part Number	Legacy Part Number
			B	H	L					
63	40	0.68	5.0	11.0	18.0	15.0	2.5	315	60DI3680(1)30(2)	R60DI3680(1)30(2)
63	40	1.0	5.0	11.0	18.0	15.0	2.5	315	60DI4100(1)30(2)	R60DI4100(1)30(2)
63	40	1.5	5.0	11.0	18.0	15.0	2.5	315	60DI4150(1)30(2)	R60DI4150(1)30(2)
63	40	2.2	6.0	12.0	18.0	15.0	2.5	315	60DI4220(1)30(2)	R60DI4220(1)30(2)
63	40	3.3	7.5	13.5	18.0	15.0	2.5	315	60DI4330(1)30(2)	R60DI4330(1)30(2)
63	40	3.3	9.0	12.5	18.0	15.0	2.5	315	60DI4330(1)L0(2)	R60DI4330(1)L0(2)
63	40	4.7	8.5	14.5	18.0	15.0	2.5	315	60DI4470(1)30(2)	R60DI4470(1)30(2)
63	40	4.7	13.0	12.0	18.0	15.0	2.5	315	60DI4470(1)L0(2)	R60DI4470(1)L0(2)
63	40	6.8	10.0	16.0	18.0	15.0	2.5	315	60DI4680(1)30(2)	R60DI4680(1)30(2)
63	40	3.3	6.0	15.0	26.5	22.5	1.5	189	60DN4330(1)30(2)	R60DN4330(1)30(2)
63	40	4.7	7.0	16.0	26.5	22.5	1.5	189	60DN4470(1)30(2)	R60DN4470(1)30(2)
63	40	6.8	7.0	16.0	26.5	22.5	1.5	189	60DN4680(1)30(2)	R60DN4680(1)30(2)
63	40	10.0	8.5	17.0	26.5	22.5	1.5	189	60DN5100(1)30(2)	R60DN5100(1)30(2)
VDC	VAC	Capacitance Value (µF)	B (mm)	H (mm)	L (mm)	Lead Spacing	dV/dt (V/µs)	Max K <sub>0</sub> (V <sup>2</sup> /µs)	New KEMET Part Number	Legacy Part Number

1) Insert lead and packaging code. See Ordering Options Table for available options.  
(2) J = 5%, K = 10%, M = 20%

**Table 1B – Ratings & Part Number Reference (Wound Capacitor Technology) cont'd**

VDC	VAC	Capacitance Value (µF)	Dimensions in mm			Lead Spacing	dV/dt (V/µs)	Maximum K <sub>0</sub> (V <sup>2</sup> /µs)	New KEMET Part Number	Legacy Part Number
			B	H	L					
63	40	15.0	11.0	20.0	26.5	22.5	1.5	189	60DN5150(1)30(2)	R60DN5150(1)30(2)
63	40	10.0	9.0	17.0	32.0	27.5	1.0	126	60DR5100(1)30(2)	R60DR5100(1)30(2)
63	40	15.0	9.0	17.0	32.0	27.5	1.0	126	60DR5150(1)40(2)	R60DR5150(1)40(2)
63	40	22.0	11.0	20.0	32.0	27.5	1.0	126	60DR5220(1)40(2)	R60DR5220(1)40(2)
63	40	33.0	13.0	22.0	32.0	27.5	1.0	126	60DR5330(1)40(2)	R60DR5330(1)40(2)
63	40	47.0	14.0	28.0	32.0	27.5	1.0	126	60DR5470(1)40(2)	R60DR5470(1)40(2)
63	40	68.0	18.0	33.0	32.0	27.5	1.0	126	60DR5680(1)40(2)	R60DR5680(1)40(2)
63	40	100.0	22.0	37.0	32.0	27.5	1.0	126	60DR6100(1)00(2)	R60DR6100(1)00(2)
63	40	22.0	11.0	22.0	41.5	37.5	0.8	101	60DW5220(1)30(2)	R60DW5220(1)30(2)
63	40	33.0	11.0	22.0	41.5	37.5	0.8	101	60DW5330(1)40(2)	R60DW5330(1)40(2)
63	40	47.0	13.0	24.0	41.5	37.5	0.8	101	60DW5470(1)40(2)	R60DW5470(1)40(2)
63	40	68.0	19.0	32.0	41.5	37.5	0.8	101	60DW5680(1)30(2)	R60DW5680(1)30(2)
63	40	100.0	19.0	32.0	41.5	37.5	0.8	101	60DW6100(1)40(2)	R60DW6100(1)40(2)
63	40	150.0	20.0	40.0	41.5	37.5	0.8	101	60DW6150(1)00(2)	R60DW6150(1)00(2)
63	40	220.0	24.0	44.0	41.5	37.5	0.8	101	60DW6220(1)00(2)	R60DW6220(1)00(2)
100	63	0.33	5.0	11.0	18.0	15.0	3.0	600	60EI3330(1)30(2)	R60EI3330(1)30(2)
100	63	0.47	5.0	11.0	18.0	15.0	3.0	600	60EI3470(1)30(2)	R60EI3470(1)30(2)
100	63	0.68	5.0	11.0	18.0	15.0	3.0	600	60EI3680(1)30(2)	R60EI3680(1)30(2)
100	63	1.0	5.0	11.0	18.0	15.0	3.0	600	60EI4100(1)30(2)	R60EI4100(1)30(2)
100	63	1.5	7.5	13.5	18.0	15.0	3.0	600	60EI4150(1)30(2)	R60EI4150(1)30(2)
100	63	2.2	8.5	14.5	18.0	15.0	3.0	600	60EI4220(1)30(2)	R60EI4220(1)30(2)
100	63	2.2	9.0	12.5	18.0	15.0	3.0	600	60EI4220(1)L0(2)	R60EI4220(1)L0(2)
100	63	3.3	10.0	16.0	18.0	15.0	3.0	600	60EI4330(1)30(2)	R60EI4330(1)30(2)
100	63	3.3	13.0	12.0	18.0	15.0	3.0	600	60EI4330(1)L0(2)	R60EI4330(1)L0(2)
100	63	4.7	11.0	19.0	18.0	15.0	3.0	600	60EI4470(1)30(2)	R60EI4470(1)30(2)
100	63	1.5	6.0	15.0	26.5	22.5	2.0	400	60EN4150(1)30(2)	R60EN4150(1)30(2)
100	63	2.2	6.0	15.0	26.5	22.5	2.0	400	60EN4220(1)30(2)	R60EN4220(1)30(2)
100	63	3.3	7.0	16.0	26.5	22.5	2.0	400	60EN4330(1)30(2)	R60EN4330(1)30(2)
100	63	4.7	8.5	17.0	26.5	22.5	2.0	400	60EN4470(1)30(2)	R60EN4470(1)30(2)
100	63	6.8	10.0	18.5	26.5	22.5	2.0	400	60EN4680(1)30(2)	R60EN4680(1)30(2)
100	63	10.0	13.0	22.0	26.5	22.5	2.0	400	60EN5100(1)30(2)	R60EN5100(1)30(2)
100	63	4.7	9.0	17.0	32.0	27.5	1.5	300	60ER4470(1)30(2)	R60ER4470(1)30(2)
100	63	6.8	9.0	17.0	32.0	27.5	1.5	300	60ER4680(1)30(2)	R60ER4680(1)30(2)
100	63	10.0	9.0	17.0	32.0	27.5	1.5	300	60ER5100(1)40(2)	R60ER5100(1)40(2)
100	63	15.0	11.0	20.0	32.0	27.5	1.5	300	60ER5150(1)40(2)	R60ER5150(1)40(2)
100	63	22.0	13.0	22.0	32.0	27.5	1.5	300	60ER5220(1)40(2)	R60ER5220(1)40(2)
100	63	33.0	14.0	28.0	32.0	27.5	1.5	300	60ER5330(1)40(2)	R60ER5330(1)40(2)
100	63	47.0	18.0	33.0	32.0	27.5	1.5	300	60ER5470(1)40(2)	R60ER5470(1)40(2)
100	63	68.0	22.0	37.0	32.0	27.5	1.5	300	60ER5680(1)00(2)	R60ER5680(1)00(2)
100	63	15.0	11.0	22.0	41.5	37.5	1.0	200	60EW5150(1)40(2)	R60EW5150(1)40(2)
100	63	22.0	11.0	22.0	41.5	37.5	1.0	200	60EW5220(1)40(2)	R60EW5220(1)40(2)
100	63	33.0	13.0	24.0	41.5	37.5	1.0	200	60EW5330(1)40(2)	R60EW5330(1)40(2)
100	63	47.0	16.0	28.5	41.5	37.5	1.0	200	60EW5470(1)40(2)	R60EW5470(1)40(2)
100	63	68.0	19.0	32.0	41.5	37.5	1.0	200	60EW5680(1)50(2)	R60EW5680(1)50(2)
100	63	100.0	20.0	40.0	41.5	37.5	1.0	200	60EW6100(1)00(2)	R60EW6100(1)00(2)
100	63	150.0	24.0	44.0	41.5	37.5	1.0	200	60EW6150(1)00(2)	R60EW6150(1)00(2)
160	90	0.33	5.0	11.0	18.0	15.0	9.0	2880	60GI3330(1)30(2)	R60GI3330(1)30(2)
160	90	0.47	5.0	11.0	18.0	15.0	9.0	2880	60GI3470(1)30(2)	R60GI3470(1)30(2)
160	90	0.68	5.0	11.0	18.0	15.0	9.0	2880	60GI3680(1)30(2)	R60GI3680(1)30(2)
160	90	1.0	7.5	13.5	18.0	15.0	9.0	2880	60GI4100(1)30(2)	R60GI4100(1)30(2)
160	90	1.5	8.5	14.5	18.0	15.0	9.0	2880	60GI4150(1)30(2)	R60GI4150(1)30(2)
160	90	1.5	9.0	12.5	18.0	15.0	9.0	2880	60GI4150(1)L0(2)	R60GI4150(1)L0(2)
160	90	2.2	10.0	16.0	18.0	15.0	9.0	2880	60GI4220(1)30(2)	R60GI4220(1)30(2)
160	90	2.2	13.0	12.0	18.0	15.0	9.0	2880	60GI4220(1)L0(2)	R60GI4220(1)L0(2)
160	90	3.3	11.0	19.0	18.0	15.0	9.0	2880	60GI4330(1)30(2)	R60GI4330(1)30(2)
160	90	1.5	6.0	15.0	26.5	22.5	5.5	1760	60GN4150(1)30(2)	R60GN4150(1)30(2)
160	90	2.2	7.0	16.0	26.5	22.5	5.5	1760	60GN4220(1)30(2)	R60GN4220(1)30(2)
160	90	3.3	8.5	17.0	26.5	22.5	5.5	1760	60GN4330(1)30(2)	R60GN4330(1)30(2)
VDC	VAC	Capacitance Value (µF)	B (mm)	H (mm)	L (mm)	Lead Spacing	dV/dt (V/µs)	Max K <sub>0</sub> (V <sup>2</sup> /µs)	New KEMET Part Number	Legacy Part Number

1) Insert lead and packaging code. See Ordering Options Table for available options.

(2) J = 5%, K = 10%, M = 20%

**Table 1B – Ratings & Part Number Reference (Wound Capacitor Technology) cont'd**

VDC	VAC	Capacitance Value (µF)	Dimensions in mm			Lead Spacing	dV/dt (V/µs)	Maximum K <sub>0</sub> (V <sup>2</sup> /µs)	New KEMET Part Number	Legacy Part Number
			B	H	L					
160	90	4.7	11.0	20.0	26.5	22.5	5.5	1760	60GN4470(1)30(2)	R60GN4470(1)30(2)
160	90	6.8	13.0	22.0	26.5	22.5	5.5	1760	60GN4680(1)30(2)	R60GN4680(1)30(2)
160	90	3.3	9.0	17.0	32.0	27.5	3.0	960	60GR4330(1)30(2)	R60GR4330(1)30(2)
160	90	4.7	9.0	17.0	32.0	27.5	3.0	960	60GR4470(1)30(2)	R60GR4470(1)30(2)
160	90	6.8	9.0	17.0	32.0	27.5	3.0	960	60GR4680(1)40(2)	R60GR4680(1)40(2)
160	90	10.0	9.0	17.0	32.0	27.5	3.0	960	60GR5100(1)40(2)	R60GR5100(1)40(2)
160	90	15.0	11.0	20.0	32.0	27.5	3.0	960	60GR5150(1)40(2)	R60GR5150(1)40(2)
160	90	22.0	13.0	22.0	32.0	27.5	3.0	960	60GR5220(1)40(2)	R60GR5220(1)40(2)
160	90	33.0	14.0	28.0	32.0	27.5	3.0	960	60GR5330(1)00(2)	R60GR5330(1)00(2)
160	90	47.0	18.0	33.0	32.0	27.5	3.0	960	60GR5470(1)00(2)	R60GR5470(1)00(2)
160	90	68.0	22.0	37.0	32.0	27.5	3.0	960	60GR5680(1)00(2)	R60GR5680(1)00(2)
160	90	10.0	11.0	22.0	41.5	37.5	2.0	640	60GW5100(1)30(2)	R60GW5100(1)30(2)
160	90	15.0	11.0	22.0	41.5	37.5	2.0	640	60GW5150(1)40(2)	R60GW5150(1)40(2)
160	90	22.0	11.0	22.0	41.5	37.5	2.0	640	60GW5220(1)40(2)	R60GW5220(1)40(2)
160	90	33.0	13.0	24.0	41.5	37.5	2.0	640	60GW5330(1)40(2)	R60GW5330(1)40(2)
160	90	47.0	16.0	28.5	41.5	37.5	2.0	640	60GW5470(1)40(2)	R60GW5470(1)40(2)
160	90	68.0	19.0	32.0	41.5	37.5	2.0	640	60GW5680(1)00(2)	R60GW5680(1)00(2)
160	90	100.00	20.0	40.0	41.5	37.5	2.0	640	60GW6100(1)00(2)	R60GW6100(1)00(2)
160	90	150.00	30.0	45.0	41.5	37.5	2.0	640	60GW6150(1)00(2)	R60GW6150(1)00(2)
250	160	0.10	5.0	11.0	18.0	15.0	12.0	6000	60II3100(1)30(2)	R60II3100(1)30(2)
250	160	0.15	5.0	11.0	18.0	15.0	12.0	6000	60II3150(1)30(2)	R60II3150(1)30(2)
250	160	0.22	5.0	11.0	18.0	15.0	12.0	6000	60II3220(1)30(2)	R60II3220(1)30(2)
250	160	0.33	5.0	11.0	18.0	15.0	12.0	6000	60II3330(1)30(2)	R60II3330(1)30(2)
250	160	0.47	6.0	12.0	18.0	15.0	12.0	6000	60II3470(1)30(2)	R60II3470(1)30(2)
250	160	0.68	7.5	13.5	18.0	15.0	12.0	6000	60II3680(1)30(2)	R60II3680(1)30(2)
250	160	0.68	9.0	12.5	18.0	15.0	12.0	6000	60II3680(1)L0(2)	R60II3680(1)L0(2)
250	160	1.0	8.5	14.5	18.0	15.0	12.0	6000	60II4100(1)30(2)	R60II4100(1)30(2)
250	160	1.0	13.0	12.0	18.0	15.0	12.0	6000	60II4100(1)L0(2)	R60II4100(1)L0(2)
250	160	1.5	10.0	16.0	18.0	15.0	12.0	6000	60II4150(1)30(2)	R60II4150(1)30(2)
250	160	0.47	6.0	15.0	26.5	22.5	8.0	4000	60IN3470(1)30(2)	R60IN3470(1)30(2)
250	160	0.68	6.0	15.0	26.5	22.5	8.0	4000	60IN3680(1)30(2)	R60IN3680(1)30(2)
250	160	1.0	6.0	15.0	26.5	22.5	8.0	4000	60IN4100(1)30(2)	R60IN4100(1)30(2)
250	160	1.5	7.0	16.0	26.5	22.5	8.0	4000	60IN4150(1)30(2)	R60IN4150(1)30(2)
250	160	2.2	10.0	18.5	26.5	22.5	8.0	4000	60IN4220(1)30(2)	R60IN4220(1)30(2)
250	160	3.3	11.0	20.0	26.5	22.5	8.0	4000	60IN4330(1)30(2)	R60IN4330(1)30(2)
250	160	1.5	9.0	17.0	32.0	27.5	5.0	2500	60IR4150(1)30(2)	R60IR4150(1)30(2)
250	160	2.2	9.0	17.0	32.0	27.5	5.0	2500	60IR4220(1)30(2)	R60IR4220(1)30(2)
250	160	3.3	9.0	17.0	32.0	27.5	5.0	2500	60IR4330(1)40(2)	R60IR4330(1)40(2)
250	160	4.7	9.0	17.0	32.0	27.5	5.0	2500	60IR4470(1)40(2)	R60IR4470(1)40(2)
250	160	6.8	11.0	20.0	32.0	27.5	5.0	2500	60IR4680(1)40(2)	R60IR4680(1)40(2)
250	160	10.0	13.0	22.0	32.0	27.5	5.0	2500	60IR5100(1)40(2)	R60IR5100(1)40(2)
250	160	15.0	14.0	28.0	32.0	27.5	5.0	2500	60IR5150(1)40(2)	R60IR5150(1)40(2)
250	160	22.0	18.0	33.0	32.0	27.5	5.0	2500	60IR5220(1)00(2)	R60IR5220(1)00(2)
250	160	33.0	22.0	37.0	32.0	27.5	5.0	2500	60IR5330(1)00(2)	R60IR5330(1)00(2)
250	160	4.7	11.0	22.0	41.5	37.5	4.0	2000	60IW4470(1)30(2)	R60IW4470(1)30(2)
250	160	6.8	11.0	22.0	41.5	37.5	4.0	2000	60IW4680(1)40(2)	R60IW4680(1)40(2)
250	160	10.0	11.0	22.0	41.5	37.5	4.0	2000	60IW5100(1)40(2)	R60IW5100(1)40(2)
250	160	15.0	13.0	24.0	41.5	37.5	4.0	2000	60IW5150(1)40(2)	R60IW5150(1)40(2)
250	160	22.0	16.0	28.5	41.5	37.5	4.0	2000	60IW5220(1)40(2)	R60IW5220(1)40(2)
250	160	33.0	19.0	32.0	41.5	37.5	4.0	2000	60IW5330(1)40(2)	R60IW5330(1)40(2)
250	160	47.0	20.0	40.0	41.5	37.5	4.0	2000	60IW5470(1)00(2)	R60IW5470(1)00(2)
250	160	68.0	24.0	44.0	41.5	37.5	4.0	2000	60IW5680(1)00(2)	R60IW5680(1)00(2)
400	200	0.022	5.0	11.0	18.0	15.0	20.0	16000	60MI2220(1)30(2)	R60MI2220(1)30(2)
400	200	0.047	5.0	11.0	18.0	15.0	20.0	16000	60MI2470(1)30(2)	R60MI2470(1)30(2)
400	200	0.068	5.0	11.0	18.0	15.0	20.0	16000	60MI2680(1)30(2)	R60MI2680(1)30(2)
400	200	0.10	5.0	11.0	18.0	15.0	20.0	16000	60MI3100(1)30(2)	R60MI3100(1)30(2)
400	200	0.15	5.0	11.0	18.0	15.0	20.0	16000	60MI3150(1)30(2)	R60MI3150(1)30(2)
400	200	0.22	5.0	11.0	18.0	15.0	20.0	16000	60MI3220(1)40(2)	R60MI3220(1)40(2)

1) Insert lead and packaging code. See Ordering Options Table for available options.

(2) J = 5%, K = 10%, M = 20%

**Table 1B – Ratings & Part Number Reference (Wound Capacitor Technology) cont'd**

VDC	VAC	Capacitance Value (µF)	Dimensions in mm			Lead Spacing	dV/dt (V/µs)	Maximum K <sub>0</sub> (V <sup>2</sup> /µs)	New KEMET Part Number	Legacy Part Number
			B	H	L					
400	200	0.22	6.0	12.0	18.0	15.0	20.0	16000	60MI3220(1)30(2)	R60MI3220(1)30(2)
400	200	0.33	7.5	13.5	18.0	15.0	20.0	16000	60MI3330(1)30(2)	R60MI3330(1)30(2)
400	200	0.33	9.0	12.5	18.0	15.0	20.0	16000	60MI3330(1)L0(2)	R60MI3330(1)L0(2)
400	200	0.47	7.5	13.5	18.0	15.0	20.0	16000	60MI3470(1)40(2)	R60MI3470(1)40(2)
400	200	0.47	8.5	14.5	18.0	15.0	20.0	16000	60MI3470(1)30(2)	R60MI3470(1)30(2)
400	200	0.47	9.0	12.5	18.0	15.0	20.0	16000	60MI3470(1)L1(2)	R60MI3470(1)L1(2)
400	200	0.47	13.0	12.0	18.0	15.0	20.0	16000	60MI3470(1)L0(2)	R60MI3470(1)L0(2)
400	200	0.68	10.0	16.0	18.0	15.0	20.0	16000	60MI3680(1)40(2)	R60MI3680(1)40(2)
400	200	0.68	11.0	19.0	18.0	15.0	20.0	16000	60MI3680(1)30(2)	R60MI3680(1)30(2)
400	200	0.68	13.0	12.0	18.0	15.0	20.0	16000	60MI3680(1)L0(2)	R60MI3680(1)L0(2)
400	200	1.0	11.0	19.0	18.0	15.0	20.0	16000	60MI4100(1)30(2)	R60MI4100(1)30(2)
400	200	0.22	6.0	15.0	26.5	22.5	10.0	8000	60MN3220(1)30(2)	R60MN3220(1)30(2)
400	200	0.33	6.0	15.0	26.5	22.5	10.0	8000	60MN3330(1)30(2)	R60MN3330(1)30(2)
400	200	0.47	6.0	15.0	26.5	22.5	10.0	8000	60MN3470(1)30(2)	R60MN3470(1)30(2)
400	200	0.68	6.0	15.0	26.5	22.5	10.0	8000	60MN3680(1)40(2)	R60MN3680(1)40(2)
400	200	0.68	7.0	16.0	26.5	22.5	10.0	8000	60MN3680(1)30(2)	R60MN3680(1)30(2)
400	200	1.0	8.5	17.0	26.5	22.5	10.0	8000	60MN4100(1)40(2)	R60MN4100(1)40(2)
400	200	1.0	10.0	18.5	26.5	22.5	10.0	8000	60MN4100(1)30(2)	R60MN4100(1)30(2)
400	200	1.5	10.0	18.5	26.5	22.5	10.0	8000	60MN4150(1)40(2)	R60MN4150(1)40(2)
400	200	1.5	11.0	20.0	26.5	22.5	10.0	8000	60MN4150(1)30(2)	R60MN4150(1)30(2)
400	200	2.2	13.0	22.0	26.5	22.5	10.0	8000	60MN4220(1)30(2)	R60MN4220(1)30(2)
400	200	0.68	9.0	17.0	32.0	27.5	8.5	6800	60MR3680(1)30(2)	R60MR3680(1)30(2)
400	200	1.0	9.0	17.0	32.0	27.5	8.5	6800	60MR4100(1)30(2)	R60MR4100(1)30(2)
400	200	1.5	9.0	17.0	32.0	27.5	8.5	6800	60MR4150(1)40(2)	R60MR4150(1)40(2)
400	200	2.2	11.0	20.0	32.0	27.5	8.5	6800	60MR4220(1)40(2)	R60MR4220(1)40(2)
400	200	3.3	13.0	22.0	32.0	27.5	8.5	6800	60MR4330(1)40(2)	R60MR4330(1)40(2)
400	200	4.7	14.0	28.0	32.0	27.5	8.5	6800	60MR4470(1)40(2)	R60MR4470(1)40(2)
400	200	6.8	18.0	33.0	32.0	27.5	8.5	6800	60MR4680(1)40(2)	R60MR4680(1)40(2)
400	200	10.0	22.0	37.0	32.0	27.5	8.5	6800	60MR5100(1)40(2)	R60MR5100(1)40(2)
400	200	3.3	11.0	22.0	41.5	37.5	6.0	4800	60MW4330(1)30(2)	R60MW4330(1)30(2)
400	200	4.7	11.0	22.0	41.5	37.5	6.0	4800	60MW4470(1)40(2)	R60MW4470(1)40(2)
400	200	6.8	13.0	24.0	41.5	37.5	6.0	4800	60MW4680(1)40(2)	R60MW4680(1)40(2)
400	200	10.0	16.0	28.5	41.5	37.5	6.0	4800	60MW5100(1)40(2)	R60MW5100(1)40(2)
400	200	15.0	24.0	44.0	41.5	37.5	6.0	4800	60MW5150(1)30(2)	R60MW5150(1)30(2)
400	200	22.0	24.0	44.0	41.5	37.5	6.0	4800	60MW5220(1)40(2)	R60MW5220(1)40(2)
400	200	33.0	30.0	45.0	41.5	37.5	6.0	4800	60MW5330(1)40(2)	R60MW5330(1)40(2)
630	220	0.0047	4.0	9.0	13.0	10.0	40.0	50400	60PF1470(1)30(2)	R60PF1470(1)30(2)
630	220	0.0068	4.0	9.0	13.0	10.0	40.0	50400	60PF1680(1)30(2)	R60PF1680(1)30(2)
630	220	0.010	4.0	9.0	13.0	10.0	40.0	50400	60PF2100(1)30(2)	R60PF2100(1)30(2)
630	220	0.015	4.0	9.0	13.0	10.0	40.0	50400	60PF2150(1)30(2)	R60PF2150(1)30(2)
630	220	0.022	4.0	9.0	13.0	10.0	40.0	50400	60PF2220(1)40(2)	R60PF2220(1)40(2)
630	220	0.022	5.0	11.0	13.0	10.0	40.0	50400	60PF2220(1)30(2)	R60PF2220(1)30(2)
630	220	0.033	5.0	11.0	13.0	10.0	40.0	50400	60PF2330(1)40(2)	R60PF2330(1)40(2)
630	220	0.033	6.0	12.0	13.0	10.0	40.0	50400	60PF2330(1)30(2)	R60PF2330(1)30(2)
630	220	0.047	6.0	12.0	13.0	10.0	40.0	50400	60PF2470(1)30(2)	R60PF2470(1)30(2)
630	220	0.033	5.0	11.0	18.0	15.0	25.0	31500	60PI2330(1)30(2)	R60PI2330(1)30(2)
630	220	0.047	5.0	11.0	18.0	15.0	25.0	31500	60PI2470(1)30(2)	R60PI2470(1)30(2)
630	220	0.068	5.0	11.0	18.0	15.0	25.0	31500	60PI2680(1)40(2)	R60PI2680(1)40(2)
630	220	0.068	6.0	12.0	18.0	15.0	25.0	31500	60PI2680(1)30(2)	R60PI2680(1)30(2)
630	220	0.10	6.0	12.0	18.0	15.0	25.0	31500	60PI3100(1)40(2)	R60PI3100(1)40(2)
630	220	0.10	7.5	13.5	18.0	15.0	25.0	31500	60PI3100(1)30(2)	R60PI3100(1)30(2)
630	220	0.10	9.0	12.5	18.0	15.0	25.0	31500	60PI3100(1)L0(2)	R60PI3100(1)L0(2)
630	220	0.15	7.5	13.5	18.0	15.0	25.0	31500	60PI3150(1)40(2)	R60PI3150(1)40(2)
630	220	0.15	8.5	14.5	18.0	15.0	25.0	31500	60PI3150(1)30(2)	R60PI3150(1)30(2)
630	220	0.22	8.5	14.5	18.0	15.0	25.0	31500	60PI3220(1)40(2)	R60PI3220(1)40(2)
630	220	0.22	10.0	16.0	18.0	15.0	25.0	31500	60PI3220(1)30(2)	R60PI3220(1)30(2)
630	220	0.33	10.0	16.0	18.0	15.0	25.0	31500	60PI3330(1)30(2)	R60PI3330(1)30(2)
630	220	0.10	6.0	15.0	26.5	22.5	12.0	15120	60PN3100(1)30(2)	R60PN3100(1)30(2)
VDC	VAC	Capacitance Value (µF)	B (mm)	H (mm)	L (mm)	Lead Spacing	dV/dt (V/µs)	Max K <sub>0</sub> (V <sup>2</sup> /µs)	New KEMET Part Number	Legacy Part Number

1) Insert lead and packaging code. See Ordering Options Table for available options.

(2) J = 5%, K = 10%, M = 20%

**Table 1B – Ratings & Part Number Reference (Wound Capacitor Technology) cont'd**

VDC	VAC	Capacitance Value (µF)	Dimensions in mm			Lead Spacing	dV/dt (V/µs)	Maximum K <sub>0</sub> (V <sup>2</sup> /µs)	New KEMET Part Number	Legacy Part Number
			B	H	L					
630	220	0.15	6.0	15.0	26.5	22.5	12.0	15120	60PN3150(1)30(2)	R60PN3150(1)30(2)
630	220	0.22	6.0	15.0	26.5	22.5	12.0	15120	60PN3220(1)40(2)	R60PN3220(1)40(2)
630	220	0.22	7.0	16.0	26.5	22.5	12.0	15120	60PN3220(1)30(2)	R60PN3220(1)30(2)
630	220	0.33	7.0	16.0	26.5	22.5	12.0	15120	60PN3330(1)50(2)	R60PN3330(1)50(2)
630	220	0.33	8.5	17.0	26.5	22.5	12.0	15120	60PN3330(1)40(2)	R60PN3330(1)40(2)
630	220	0.33	10.0	18.5	26.5	22.5	12.0	15120	60PN3330(1)30(2)	R60PN3330(1)30(2)
630	220	0.47	10.0	18.5	26.5	22.5	12.0	15120	60PN3470(1)40(2)	R60PN3470(1)40(2)
630	220	0.47	11.0	20.0	26.5	22.5	12.0	15120	60PN3470(1)30(2)	R60PN3470(1)30(2)
630	220	0.68	11.0	20.0	26.5	22.5	12.0	15120	60PN3680(1)40(2)	R60PN3680(1)40(2)
630	220	0.68	13.0	22.0	26.5	22.5	12.0	15120	60PN3680(1)30(2)	R60PN3680(1)30(2)
630	220	0.33	9.0	17.0	32.0	27.5	10.0	12600	60PR3330(1)30(2)	R60PR3330(1)30(2)
630	220	0.47	9.0	17.0	32.0	27.5	10.0	12600	60PR3470(1)40(2)	R60PR3470(1)40(2)
630	220	0.68	11.0	20.0	32.0	27.5	10.0	12600	60PR3680(1)40(2)	R60PR3680(1)40(2)
630	220	1.0	11.0	20.0	32.0	27.5	10.0	12600	60PR4100(1)50(2)	R60PR4100(1)50(2)
630	220	1.5	18.0	33.0	32.0	27.5	10.0	12600	60PR4150(1)30(2)	R60PR4150(1)30(2)
630	220	2.2	18.0	33.0	32.0	27.5	10.0	12600	60PR4220(1)40(2)	R60PR4220(1)40(2)
630	220	3.3	22.0	37.0	32.0	27.5	10.0	12600	60PR4330(1)40(2)	R60PR4330(1)40(2)
630	220	4.7	22.0	37.0	32.0	27.5	10.0	12600	60PR4470(1)40(2)	R60PR4470(1)40(2)
630	220	1.0	11.0	22.0	41.5	37.5	8.0	10080	60PW4100(1)30(2)	R60PW4100(1)30(2)
630	220	1.5	11.0	22.0	41.5	37.5	8.0	10080	60PW4150(1)40(2)	R60PW4150(1)40(2)
630	220	2.2	13.0	24.0	41.5	37.5	8.0	10080	60PW4220(1)40(2)	R60PW4220(1)40(2)
630	220	3.3	16.0	28.5	41.5	37.5	8.0	10080	60PW4330(1)40(2)	R60PW4330(1)40(2)
630	220	4.7	19.0	32.0	41.5	37.5	8.0	10080	60PW4470(1)40(2)	R60PW4470(1)40(2)
630	220	6.8	20.0	40.0	41.5	37.5	8.0	10080	60PW4680(1)00(2)	R60PW4680(1)00(2)
630	220	10.0	24.0	44.0	41.5	37.5	8.0	10080	60PW5100(1)40(2)	R60PW5100(1)40(2)
1000	250	0.0010	4.0	9.0	13.0	10.0	60.0	120000	60QF1100(1)01(2)	R60QF1100(1)01(2)
1000	250	0.0015	4.0	9.0	13.0	10.0	60.0	120000	60QF1150(1)01(2)	R60QF1150(1)01(2)
1000	250	0.0022	4.0	9.0	13.0	10.0	60.0	120000	60QF1220(1)01(2)	R60QF1220(1)01(2)
1000	250	0.0033	4.0	9.0	13.0	10.0	60.0	120000	60QF1330(1)01(2)	R60QF1330(1)01(2)
1000	250	0.0047	5.0	11.0	13.0	10.0	60.0	120000	60QF1470(1)01(2)	R60QF1470(1)01(2)
1000	250	0.0068	6.0	12.0	13.0	10.0	60.0	120000	60QF1680(1)01(2)	R60QF1680(1)01(2)
1000	250	0.010	5.0	11.0	18.0	15.0	30.0	60000	60QI2100(1)00(2)	R60QI2100(1)00(2)
1000	250	0.015	5.0	11.0	18.0	15.0	30.0	60000	60QI2150(1)30(2)	R60QI2150(1)30(2)
1000	250	0.022	6.0	12.0	18.0	15.0	30.0	60000	60QI2220(1)30(2)	R60QI2220(1)30(2)
1000	250	0.033	7.5	13.5	18.0	15.0	30.0	60000	60QI2330(1)30(2)	R60QI2330(1)30(2)
1000	250	0.033	9.0	12.5	18.0	15.0	30.0	60000	60QI2330(1)L0(2)	R60QI2330(1)L0(2)
1000	250	0.047	10.0	16.0	18.0	15.0	30.0	60000	60QI2470(1)00(2)	R60QI2470(1)00(2)
1000	250	0.047	13.0	12.0	18.0	15.0	30.0	60000	60QI2470(1)L0(2)	R60QI2470(1)L0(2)
1000	250	0.068	11.0	19.0	18.0	15.0	30.0	60000	60QI2680(1)00(2)	R60QI2680(1)00(2)
1000	250	0.033	6.0	15.0	26.5	22.5	15.0	30000	60QN2330(1)00(2)	R60QN2330(1)00(2)
1000	250	0.047	6.0	15.0	26.5	22.5	15.0	30000	60QN2470(1)00(2)	R60QN2470(1)00(2)
1000	250	0.068	7.0	16.0	26.5	22.5	15.0	30000	60QN2680(1)30(2)	R60QN2680(1)30(2)
1000	250	0.10	8.5	17.0	26.5	22.5	15.0	30000	60QN3100(1)30(2)	R60QN3100(1)30(2)
1000	250	0.15	13.0	22.0	26.5	22.5	15.0	30000	60QN3150(1)00(2)	R60QN3150(1)00(2)
1000	250	0.15	9.0	17.0	32.0	27.5	12.0	24000	60QR3150(1)30(2)	R60QR3150(1)30(2)
1000	250	0.22	9.0	17.0	32.0	27.5	12.0	24000	60QR3220(1)40(2)	R60QR3220(1)40(2)
1000	250	0.33	11.0	20.0	32.0	27.5	12.0	24000	60QR3330(1)40(2)	R60QR3330(1)40(2)
1000	250	0.47	13.0	22.0	32.0	27.5	12.0	24000	60QR3470(1)40(2)	R60QR3470(1)40(2)
1000	250	0.68	14.0	28.0	32.0	27.5	12.0	24000	60QR3680(1)40(2)	R60QR3680(1)40(2)
1000	250	1.0	18.0	33.0	32.0	27.5	12.0	24000	60QR4100(1)40(2)	R60QR4100(1)40(2)
1000	250	1.5	22.0	37.0	32.0	27.5	12.0	24000	60QR4150(1)40(2)	R60QR4150(1)40(2)
1000	250	0.5	11.0	22.0	41.5	37.5	10.0	20000	60QW3470(1)30(2)	R60QW3470(1)30(2)
1000	250	0.7	11.0	22.0	41.5	37.5	10.0	20000	60QW3680(1)40(2)	R60QW3680(1)40(2)
1000	250	1.0	13.0	24.0	41.5	37.5	10.0	20000	60QW4100(1)40(2)	R60QW4100(1)40(2)
1000	250	1.5	16.0	28.5	41.5	37.5	10.0	20000	60QW4150(1)40(2)	R60QW4150(1)40(2)
1000	250	2.2	19.0	32.0	41.5	37.5	10.0	20000	60QW4220(1)30(2)	R60QW4220(1)30(2)
1000	250	3.3	24.0	44.0	41.5	37.5	10.0	20000	60QW4330(1)00(2)	R60QW4330(1)00(2)
1000	250	4.7	30.0	45.0	41.5	37.5	10.0	20000	60QW4470(1)40(2)	R60QW4470(1)40(2)

1) Insert lead and packaging code. See Ordering Options Table for available options.

(2) J = 5%, K = 10%, M = 20%



## Soldering Process

The implementation of the RoHS directive has resulted in the selection of SnAgCu (SAC) alloys or SnCu alloys as primary solder. This has increased the liquidus temperature from that of 183°C for SnPb eutectic alloy to 217 – 221°C for the new alloys. As a result, the heat stress to the components, even in wave soldering, has increased considerably due to higher pre-heat and wave temperatures. Polypropylene capacitors are especially sensitive to heat (the melting point of polypropylene is 160 – 170°C). Wave soldering can be destructive, especially for mechanically small polypropylene capacitors (with lead spacing of 5 mm to 15 mm), and great care has to be taken during soldering. The recommended solder profiles from KEMET should be used. Please consult KEMET with any questions. In general, the wave soldering curve from IEC Publication 61760-1 Edition 2 serves as a solid guideline for successful soldering. Please see Figure 1.

Reflow soldering is not recommended for through-hole film capacitors. Exposing capacitors to a soldering profile in excess of the above the recommended limits may result to degradation or permanent damage to the capacitors.

Do not place the polypropylene capacitor through an adhesive curing oven to cure resin for surface mount components. Insert through-hole parts after the curing of surface mount parts. Consult KEMET to discuss the actual temperature profile in the oven, if through-hole components must pass through the adhesive curing process. A maximum two soldering cycles is recommended. Please allow time for the capacitor surface temperature to return to a normal temperature before the second soldering cycle.

**Figure 1**

Dielectric Film Material	Maximum Preheat Temperature			Maximum Peak Soldering Temperature	
	Capacitor Lead Spacing <10 mm	Capacitor Lead Spacing = 15 mm	Capacitor Lead Spacing >15 mm	Capacitor Lead Spacing <15 mm	Capacitor Lead Spacing >15 mm
Polyester	130°C	130°C	130°C	270°C	270°C
Polypropylene	100°C	110°C	130°C	260°C	270°C
Polyphenylene Sulphide	150°C	150°C	160°C	270°C	270°C

## Wave Soldering Recommendations

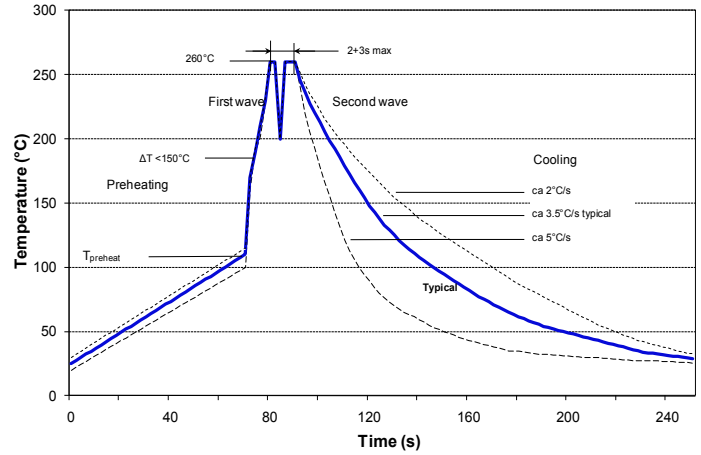

## Manual Soldering Recommendations

Following is the recommendation for manual soldering with a soldering iron.

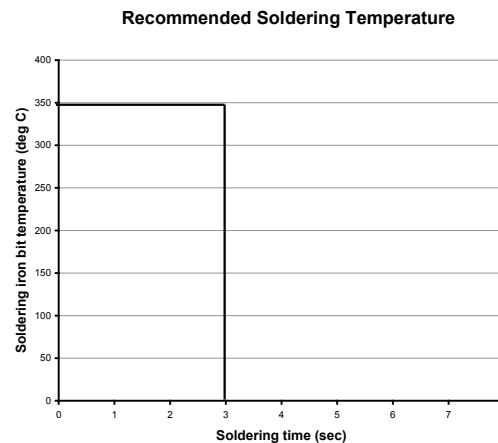

The soldering iron tip temperature should be set at 350°C (+10°C maximum) with the soldering duration not to exceed more than 3 seconds.

## Soldering Process cont'd

### Selective Soldering Recommendations

Selective dip soldering is a variation of reflow soldering. In this method, the printed circuit board with through-hole components to be soldered is preheated and transported over the solder bath as in normal flow soldering without touching the solder. When the board is over the bath, it is stopped and pre-designed solder pots are lifted from the bath with molten solder only at the places of the selected components, and pressed against the lower surface of the board to solder the components.

The temperature profile for selective soldering is similar to the double wave flow soldering outlined in this document, **however, instead of two baths, there is only one with a time from 3 to 10 seconds.** In selective soldering, the risk of overheating is greater than in double wave flow soldering, and great care must be taken so that the parts are not overheated.

---

## Marking

- KEMET's logo
- Capacitance
- Capacitance tolerance
- Rated DC voltage

## Packaging Quantities

Lead Spacing	Thickness (mm)	Height (mm)	Length (mm)	Bulk Short Leads	Bulk Long Leads	Standard Reel ø 355 mm	Large Reel ø 500 mm	Ammo
10	4.0	9.0	13.0	2,000	1,800	750	1,500	1,000
	5.0	11.0	13.0	1,300	1,500	600	1,250	800
	6.0	12.0	13.0	1,000	1,200	500	1,000	680
15	5.0	11.0	18.0	2,000	1,000	600	1,250	800
	6.0	12.0	18.0	1,750	900	500	1,000	680
	7.5	13.5	18.0	1,000	700	350	800	500
	8.5	14.5	18.0	1,000	500	300	700	440
	9.0	12.5	18.0	1,000	520	270	650	410
	10.0	16.0	18.0	750	500	300	600	380
	11.0	19.0	18.0	450	350	-	500	340
13.0	12.0	18.0	750	490	200	480	280	
22.5	6.0	15.0	26.5	805	500		700	464
	7.0	16.0	26.5	700	500		550	380
	8.5	17.0	26.5	468	300		450	280
	10.0	18.5	26.5	396	300		350	235
	11.0	20.0	26.5	360	250		350	217
	13.0	22.0	26.5	300	200		300	-
27.5	9.0	17.0	32.0	816	408		450	
	11.0	20.0	32.0	560	336		350	
	13.0	22.0	32.0	480	288		300	
	14.0	28.0	32.0	352	176			
	18.0	33.0	32.0	256	128			
	22.0	37.0	32.0	168	112			
37.5	11.0	22.0	41.5	420	252			
	13.0	24.0	41.5	360	216			
	16.0	28.5	41.5	216	108			
	19.0	32.0	41.5	192	96			
	20.0	40.0	41.5	126	84			
	24.0	44.0	41.5	108	72			
	30.0	45.0	41.5	90	60			



## Lead Taping & Packaging (IEC 60286–2)

Figure 1 – Lead Space 10 mm

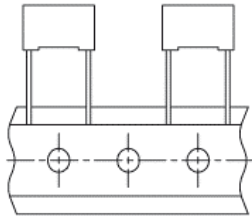

Figure 2 – Lead Spacing 15 mm

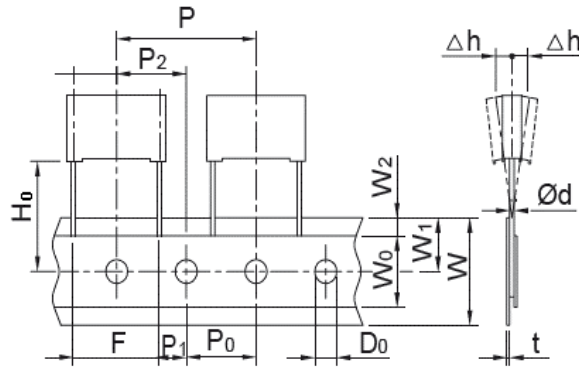
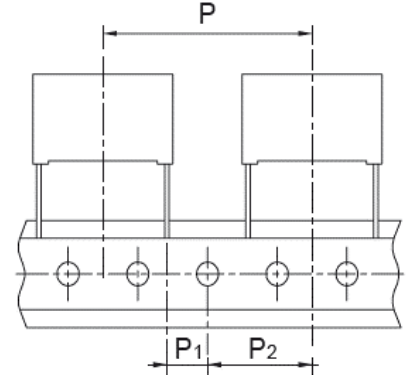

Figure 3 – Lead Spacing 22.5 & 27.5 mm



Description	Symbol	Dimensions (mm)					Tolerance
		Lead Space					
		10.0 Figure 1	15.0 Figure 2	22.5 Figure 3	27.5 Figure 3		
Lead wire diameter	d	0.6	0.6 - 0.8	0.8	0.8	± 0.05	
Taping lead space	P	25.4	25.4	38.1	38.1	± 1	
Feed hole lead space*	P <sub>0</sub>	12.7	12.7	12.7	12.7	± 0.2 **	
Centering of the lead wire	P <sub>1</sub>	7.7	5.2	7.8	5.3	± 0.7	
Centering of the body	P <sub>2</sub>	12.7	12.7	19.05	19.05	± 1.3	
Lead spacing***	F	10.0	15.0	22.5	27.5	+0.6 / -0.1	
Component alignment	Δh	0	0	0	0	± 2	
Height of component from tape center	H <sub>0</sub> ****	18.5	18.5	18.5	18.5	± 0.5	
Carrier tape width	W	18	18	18	18	+1 / -0.5	
Hold down tape width	W <sub>0</sub>	9	10	10	10	min.	
Hole position	W <sub>1</sub>	9	9	9	9	± 0.5	
Hold down tape position	W <sub>2</sub>	3	3	3	3	max.	
Feed hole diameter	D <sub>0</sub>	4	4	4	4	± 0.2	
Tape thickness	t	0.7	0.7	0.7	0.7	± 0.2	

\* Available also 15 mm.

\*\* Maximum 1 mm on 20 lead spaces.

\*\*\* Lead Spacing 15mm and 10mm taped to 7.5 mm (crimped leads) available upon request.

\*\*\*\* H = 16.5 mm is available upon request.

## Ammo Specifications

Dimensions in mm		
H	W	T
360	340	59

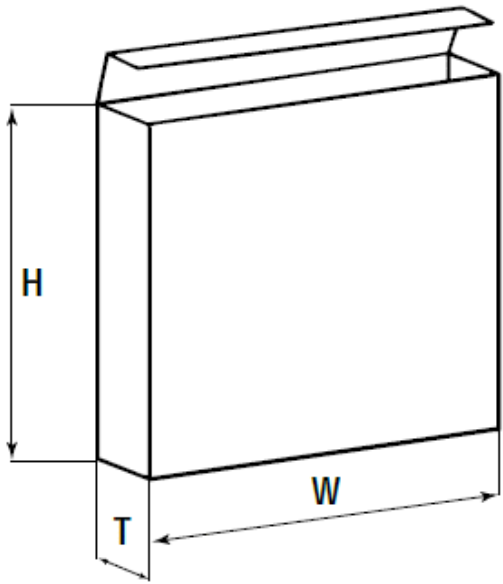

## Reel Specifications

Dimensions in mm		
D	H	W
355	30	55 maximum
500	25	

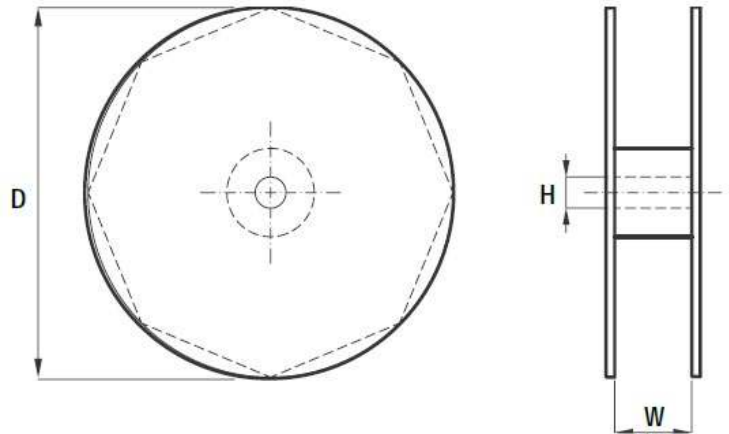

## KEMET Corporation World Headquarters

2835 KEMET Way  
Simpsonville, SC 29681

Mailing Address:  
P.O. Box 5928  
Greenville, SC 29606

www.kemet.com  
Tel: 864-963-6300  
Fax: 864-963-6521

**Corporate Offices**  
Fort Lauderdale, FL  
Tel: 954-766-2800

## North America

**Southeast**  
Lake Mary, FL  
Tel: 407-855-8886

**Northeast**  
Wilmington, MA  
Tel: 978-658-1663

**Central**  
Novi, MI  
Tel: 248-306-9353

**West**  
Milpitas, CA  
Tel: 408-433-9950

**Mexico**  
Guadalajara, Jalisco  
Tel: 52-33-3123-2141

## Europe

**Southern Europe**  
Paris, France  
Tel: 33-1-4646-1006

Sasso Marconi, Italy  
Tel: 39-051-939111

**Central Europe**  
Landsberg, Germany  
Tel: 49-8191-3350800

Kamen, Germany  
Tel: 49-2307-438110

**Northern Europe**  
Bishop's Stortford, United Kingdom  
Tel: 44-1279-460122

Espoo, Finland  
Tel: 358-9-5406-5000

## Asia

**Northeast Asia**  
Hong Kong  
Tel: 852-2305-1168

Shenzhen, China  
Tel: 86-755-2518-1306

Beijing, China  
Tel: 86-10-5829-1711

Shanghai, China  
Tel: 86-21-6447-0707

Taipei, Taiwan  
Tel: 886-2-27528585

**Southeast Asia**  
Singapore  
Tel: 65-6586-1900

Penang, Malaysia  
Tel: 60-4-6430200

Bangalore, India  
Tel: 91-806-53-76817

*Note: KEMET reserves the right to modify minor details of internal and external construction at any time in the interest of product improvement. KEMET does not assume any responsibility for infringement that might result from the use of KEMET Capacitors in potential circuit designs. KEMET is a registered trademark of KEMET Electronics Corporation.*

## Disclaimer

All product specifications, statements, information and data (collectively, the "Information") in this datasheet are subject to change. The customer is responsible for checking and verifying the extent to which the Information contained in this publication is applicable to an order at the time the order is placed.

All Information given herein is believed to be accurate and reliable, but it is presented without guarantee, warranty, or responsibility of any kind, expressed or implied.

Statements of suitability for certain applications are based on KEMET Electronics Corporation's ("KEMET") knowledge of typical operating conditions for such applications, but are not intended to constitute – and KEMET specifically disclaims – any warranty concerning suitability for a specific customer application or use. The Information is intended for use only by customers who have the requisite experience and capability to determine the correct products for their application. Any technical advice inferred from this Information or otherwise provided by KEMET with reference to the use of KEMET's products is given gratis, and KEMET assumes no obligation or liability for the advice given or results obtained.

Although KEMET designs and manufactures its products to the most stringent quality and safety standards, given the current state of the art, isolated component failures may still occur. Accordingly, customer applications which require a high degree of reliability or safety should employ suitable designs or other safeguards (such as installation of protective circuitry or redundancies) in order to ensure that the failure of an electrical component does not result in a risk of personal injury or property damage.

Although all product-related warnings, cautions and notes must be observed, the customer should not assume that all safety measures are indicated or that other measures may not be required.