

PCB MAX SIZE

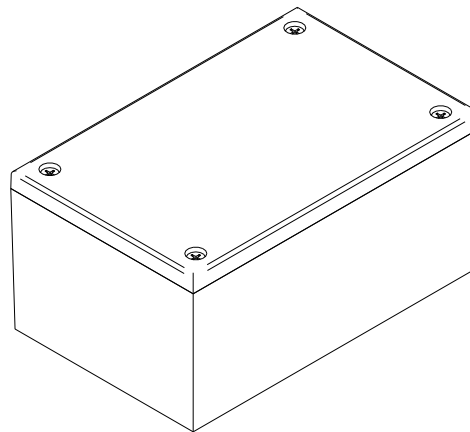
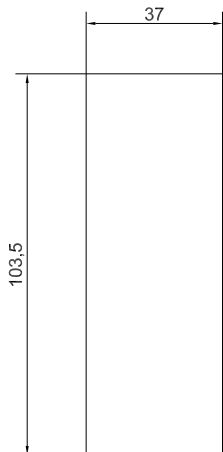

	Denomination	Assembly CP/2		Part. Number	CP/2
	Subject to technical modification without prior notice. Tipographical and other errors do not justify any claim for damages. All dimensions should be verified using an actual moulded part.				
	This document contains proprietary information of TEKO S.p.a. and is tendered subject to the conditions that the information be retained in confidence not be reproduced or copied and not be used or incorporated in any product.			Date	14/12/2005
				Scale	Format design