



VARITRONIX

VL-FS-COG-VLGEM1277-01 REV.B

(COG-VLGEM1277-01)

FEB/2009

PAGE 1 OF 37

DOCUMENT NUMBER AND REVISION

VL-FS-COG-VLGEM1277-01 REV.B

(COG- VLGEM1277)

DOCUMENT TITLE:

SPECIFICATION

OF

LCD MODULE TYPE

CUSTOMER	IVLG01
MODEL NUMBER	COG-VLGEM1277-01
CUSTOMER APPROVAL	
DATE	

DEPARTMENT	NAME	SIGNATURE	DATE
PREPARED BY	LINDA ZHU	<i>Linda Zhu</i>	2009.2.19
CHECKED BY	TAN XIAO DI	<i>Tan xiao di</i>	2009.2.19
APPROVED BY	PRITT LEE	<i>Pritt Lee</i>	2009.2.19.

DISTRIBUTION LIST: MARKETING



DOCUMENT REVISION HISTORY

DOCUMENT REVISION		DATE	DESCRIPTION	CHANGED BY	CHECKED BY
FROM	TO				
	A	2009.02.10	First Release	LINDA ZHU	TAN XIAO DI
A	B	2009.02.19	Items 1 to 3 were updated. 1.) (Whole document) Page no. and Point no. were updated. 2.) (Page 10, Table 5) Luminance on display surface & Lifetime of the LED were added. 3.) (Page 3 & 21, Point 7) Electro-Optical Characteristics was added.	LINDA ZHU	TAN XIAO DI

CONTENTS

		<u>Page No.</u>
1.	GENERAL DESCRIPTION	4
2.	MECHANICAL SPECIFICATIONS	4
3.	INTERFACE SIGNALS	7
4.	ABSOLUTE MAXIMUM RATINGS	8
4.1	ELECTRICAL MAXIMUM RATINGS –FOR IC ONLY	8
4.2	ENVIRONMENTAL CONDITION	9
5.	ELECTRICAL SPECIFICATIONS	10
5.1	TYPICAL ELECTRICAL CHARACTERISTICS	10
5.2	TIMING SPECIFICATIONS	10
6.	LCD SPECIFICATIONS	13
7.	ELECTRO-OPTICAL CHARACTERISTICS	21
7.1	OPTICAL CHARACTERISTICS DEFINITION	21
8.	LCD COSMETIC CONDITIONS	23
9.	REMARK	37

VARITRONIX LIMITED

**Specification
 of
 LCD Module Type
 Model No.: COG-VLGEM1277-01**

1. General Description

- 240 x 64 dots, STN, Negative, Blue, Transmissive LCD module.
- Viewing angle: 12 o'clock.
- Driving scheme: 1/64 duty, 1/9 bias.
- 'EPSON' S1D15721D00B000 (COG) a single chip MLS driver for dot matrix LCD or equivalent.
- Logic voltage: 3.3V.
- FPC connection.
- White LED02 backlight.
- "RoHS" compliance.

2. Mechanical Specifications

The mechanical detail is shown in Fig. 1 and summarized in Table 1 below.

Table 1

Parameter	Specifications	Unit
Outline dimensions	126.0(W) x 195.9(H) x 8.1(D) (Include FPC and LCD end-seal, exclude Connector of backlight)	mm
Viewing area	102.40(W) x 30.22(H)	mm
Active area	98.38(W) x 26.22(H)	mm
Display format	240 x 64	dots
Dot size	0.39(W) x 0.39(H)	mm
Dot spacing	0.02(W) x 0.02(H)	mm
Dot pitch	0.41(W) x 0.41(H)	mm
Weight	Approx: 52	gram

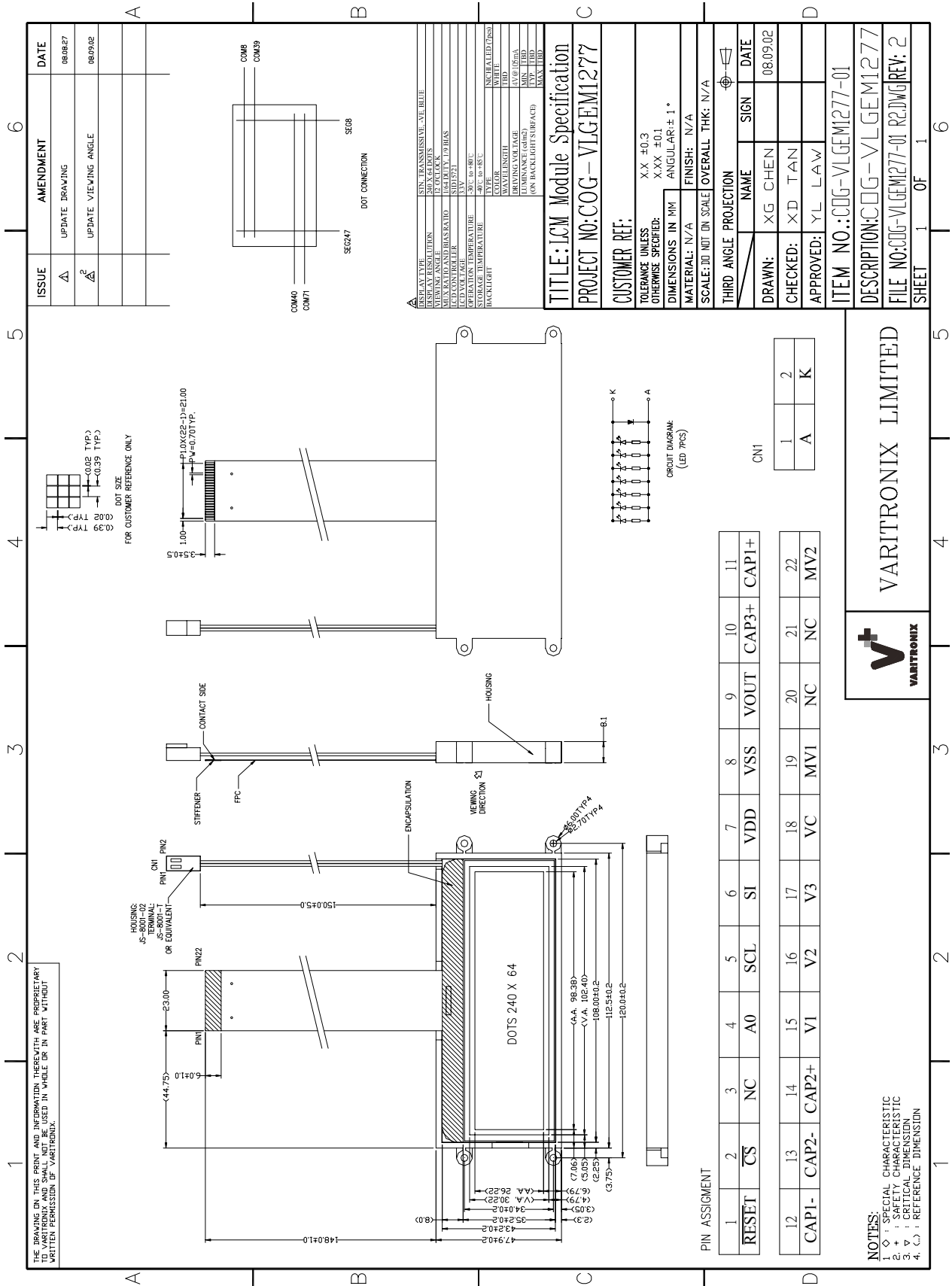

Figure 1: Module specification

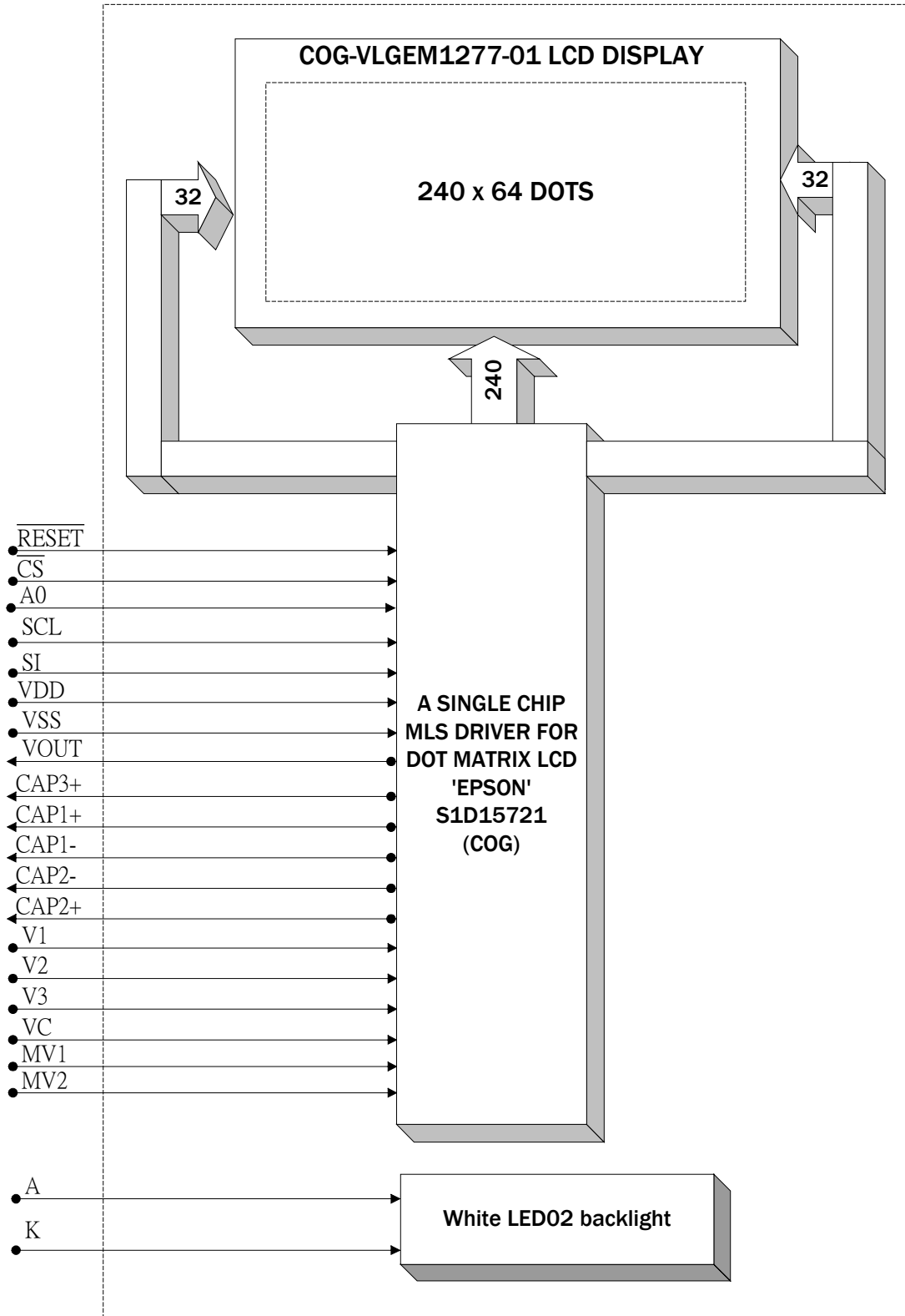

Figure 2: Block diagram

3. Interface signals

Table 2(a): Pin assignment

Pin No.	Symbol	Description
1	$\overline{\text{RESET}}$	When the $\overline{\text{RESET}}$ is LOW, initializations is achieved. Resetting operation is done on the level of the $\overline{\text{RESET}}$ signal.
2	$\overline{\text{CS}}$	A chip select signal. When $\overline{\text{CS}} = \text{LOW}$, signals are active, and data/command input/output are enabled. When $\overline{\text{CS}} = \text{HIGH}$, the data bus is caused to high impedance.
3	NC	No connection.
4	A0	Normally, the least significant bit MPU address bus is connected to distinguish between data and command. A0 = HIGH: indicates that D0 to D7 are display data or command parameters. A0 = LOW: indicates that D0 to D7 are control commands.
5	SCL	Serial clock input.
6	SI	Serial data input.
7	VDD	Connect to system MPU power supply pin VCC.
8	VSS	Ground (0V).
9	VOOUT	Output pin for step-up. Connect the capacitor between this pin and VDD2.
10	CAP3+	Pin connected to the positive side of the step-up capacitor. Connect the capacitor between this pin and CAP1- pin.
11	CAP1+	Pin connected to the positive side of the step-up capacitor. Connect the capacitor between this pin and CAP1- pin.
12	CAP1-	Pin connected to the negative side of the step-up capacitor. Connect the capacitor between this pin and CAP1+ pin.
13	CAP2-	Pin connected to the negative side of the step-up capacitor. Connect the capacitor between this pin and CAP2+ pin.
14	CAP2+	Pin connected to the positive side of the step-up capacitor. Connect the capacitor between this pin and CAP2- pin.
15	V1	A liquid crystal drive multi-level power supply. The voltages determined by the liquid crystal cell are impedance-converted by resistive divider and operational amplifier for application. The following order must be maintained: $V3 \geq V2 \geq V1 \geq VC \geq MV1 \geq MV2 \geq VSS$.
16	V2	
17	V3	
18	VC	
19	MV1	
22	MV2	MV3 is short circuited with VSS inside the IC chips. Master operation: When power supply is turned on, the following voltage is applied to each pin by the built-in power supply circuit.
20, 21	NC	No connection.

Table 2(b): Pin assignment for CN1

Pin No.	Symbol	Description
1	A	Anode of backlight input.
2	K	Cathode of backlight input.

4. Absolute Maximum Ratings

4.1 Electrical Maximum Ratings – for IC Only

Table 3

Parameter	Symbol	Min.	Max.	Unit
Power voltage (VDD)	VDD	-0.3	+6.0	V
Power voltage (VDD2)	VDD2	VDD	+6.0	V
Power voltage (VDI) (requires external input)	VDI	-0.3	+3.6	V
Power voltage (V3, VOUT)	V3, VOUT	-0.3	18.0	V
Power voltage (V2, V1, VC, MV1, MV2)	V2, V1, VC, MV1, MV2	-0.3	V3	V
Input voltage	V _{in}	-0.3	VDD+0.3	V
Output voltage	V _o	-0.3	VDD+0.3	V

- Notes: 1. Always keep the voltages of V3, V2, V1, VC, MV1 and MV2 in the following condition:
 $V3 \geq V2 \geq V1 \geq VC \geq MV1 \geq MV2 \geq VSS$. When inputting these voltages from outside, bring them to the high impedance status during resetting by \overline{RES} pin and input voltages that satisfy the above condition after releasing the reset.
2. For voltage of VOUT, always keep $VOUT \geq VDD2$. When inputting VOUT from outside, bring it to the high impedance status during resetting by \overline{RES} pin and input a voltage that satisfies $VOUT \geq V3+0.2V$ after releasing the reset.
3. If the LSI has been used in excess of the absolute maximum rating, it may be subjected to permanent breakdown. So in the normal operation, the LSI preferred to be used under the condition of electrical characteristics. If this condition is not met, LSI operation error may occur and LSI reliability may be deteriorated.
4. All voltage values are referenced to VSS= 0V unless otherwise specified.

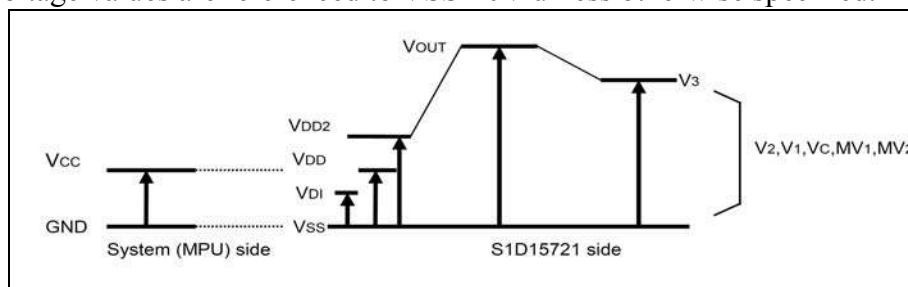

Figure 3



4.2 Environmental Conditions

Table 4

Item	Operating temperature (Topr)		Storage temperature (Tstg) (Note 1)		Remark
	Min.	Max.	Min.	Max.	
Ambient temperature	-30°C	+80°C	-40°C	+85°C	Dry
Humidity (Note 1)	90% max. RH for $T_a \leq 40^\circ\text{C}$ $< 50\%$ RH for $40^\circ\text{C} < T_a \leq$ Maximum operating temperature				No condensation
Vibration (IEC 68-2-6) cells must be mounted on a suitable connector	Frequency: 10 ~ 55 Hz Amplitude: 0.75 mm Duration: 20 cycles in each direction.				3 directions
Shock (IEC 68-2-27) Half-sine pulse shape	Pulse duration: 11 ms Peak acceleration: $981 \text{ m/s}^2 = 100\text{g}$ Number of shocks: 3 shocks in 3 mutually perpendicular axes.				3 directions

Note 1: Product cannot sustain at extreme storage conditions for long time.

5. Electrical Specifications

5.1 Typical Electrical Characteristics

At $T_a = 25\text{ }^\circ\text{C}$, $V_{DD} = 3.3\text{V} \pm 5\%$, $V_{SS} = 0\text{V}$.

Table 5

Parameter	Symbol	Conditions	Min.	Typ.	Max.	Unit
Supply voltage (logic)	V_{DD-VSS}		3.14	3.3	3.47	V
Supply voltage (LCD) (built-in)	V_{3-VSS}	$T_a = -30\text{ }^\circ\text{C}$, $V_{DD} = 3.3\text{V}$, Note 1	-	10.4	-	V
		$T_a = +25\text{ }^\circ\text{C}$, $V_{DD} = 3.3\text{V}$, Note 1	9.5	10.0	10.5	V
		$T_a = +80\text{ }^\circ\text{C}$, $V_{DD} = 3.3\text{V}$, Note 1	-	9.0	-	V
Low-level input voltage	V_{ILC}	Note 2	V_{SS}	-	$0.2 \times V_{DD}$	V
High-level input voltage	V_{IHC}	Note 2	$0.8 \times V_{DD}$	-	V_{DD}	V
Supply current (logic & LCD)	IDD	Character mode	-	0.7	1.1	mA
		Checker board mode	-	0.9	1.4	mA
Supply voltage of White LED02 backlight	V_{LED}	Forward current = 105mA Number of LED dies = 7	3.8	4.0	4.2	V
Luminance of backlight (on the backlight surface)			550	800	-	cd/m^2
Luminance on display surface			-	60	-	cd/m^2
Lifetime of the LEDs		25degree, 60%RH, 105mA (15mA /led)	40000			hrs

Note 1: There is tolerance in optimum LCD driving voltage during production and it will be within the specified range.

Note 2: A0, SCL, SI, $\overline{\text{CS}}$ and $\overline{\text{RESET}}$.

5.2 Timing Specifications

5.2.1 Reset input timing

At $T_a = -30\text{ }^\circ\text{C}$ to $+80\text{ }^\circ\text{C}$, $V_{DD} = +3.3\text{V} \pm 5\%$, $V_{SS} = 0\text{V}$.

Table 6

Parameter	Signal	Symbol	Condition	Specified value			Unit
				Min.	Typ.	Max.	
Reset time	$\overline{\text{RES}}$	t_r	—	—	—	1	μs
Reset LOW pulse width	$\overline{\text{RES}}$	t_{rw}	—	1	—	—	

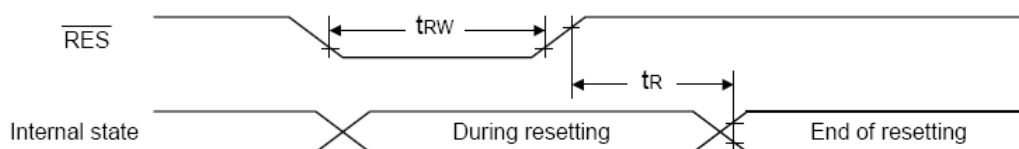

Figure 4: Reset input timing

5.2.2 Serial Interface

At $T_a = -30^{\circ}\text{C}$ to $+80^{\circ}\text{C}$, $V_{DD} = +3.3\text{V} \pm 5\%$, $V_{SS} = 0\text{V}$.

Table 7

Parameter	Signal	Symbol	Condition	Specified		Unit
				Min.	Max.	
Serial clock period	SCL	t_{SCYC}		250	—	ns
SCL HIGH pulse width		t_{SHW}		100	—	
SCL LOW pulse width		t_{SLW}		100	—	
Address setup time	A0	t_{SAS}		150	—	
Address hold time		t_{SAH}		150	—	
Data setup time	SI	t_{SDS}		100	—	
Data hold time		t_{SDH}		100	—	
CS-SCL time	CS	t_{CSS}		150	—	
		t_{CSH}		150	—	

- *1. Input signal rise and fall time (t_r , t_f) must not exceed 15ns.
- *2. Timing is entirely specified with reference to 20% or 80% of VDD.

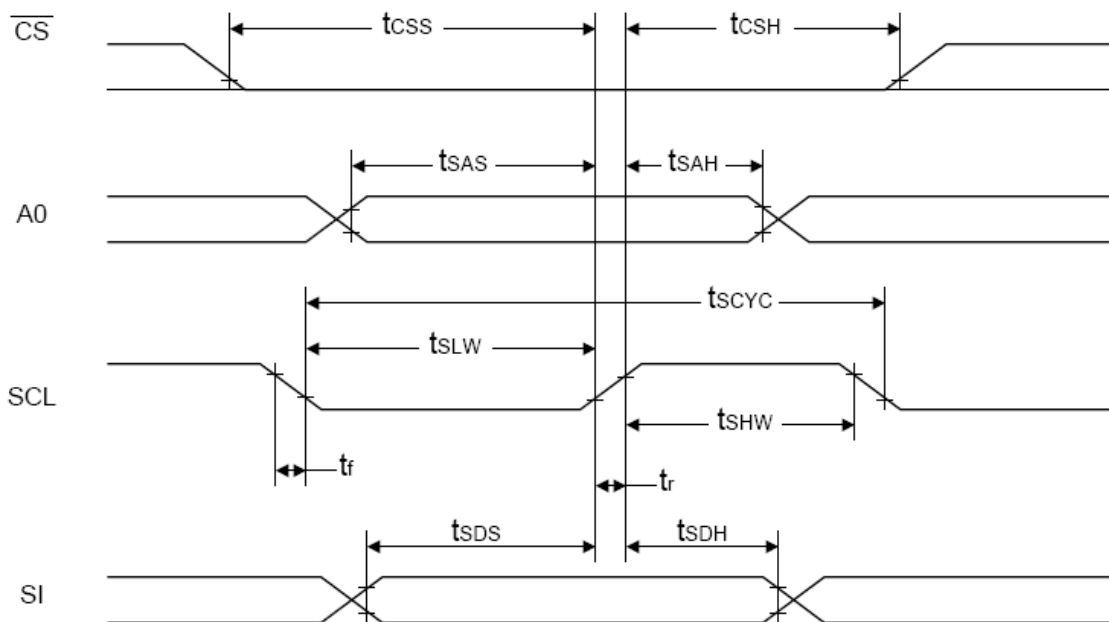

Figure 5: Serial Interface Timing

5.2.3 Temperature Sensor Measuring Timing

At $T_a = -30^{\circ}\text{C}$ to $+80^{\circ}\text{C}$, $V_{DD} = +3.3\text{V} \pm 5\%$, $V_{SS} = 0\text{V}$.

Table 8

Parameter	Signal	Symbol	Condition	Specified value			Unit
				Min.	Typ.	Max.	
MPU access cycle	WR/RD (80 series MPU) Enable (68 series MPU) SCL (Serial Interface)	f_{SACC}	—	—	—	0	Hz
Sampling setup time	SVD2	t_{SSVD2}		1	—	—	ms
Sampling hold time	SVD2	t_{HSVD2}		0	—	—	ms

- *1. While detecting outputs from SVD2, stop access from the MPU (input from the $\overline{\text{WR}}$ or $\overline{\text{RD}}$ pin when the 80 series MPU is used, input from Enable pin when the 68 series MPU is used, input from SCL pin when the serial interface is used).
- *2. Waiting time after stopping access from MPU and until SVD2 comes to be sampled.. This applies when the temperature sensor circuit has been turned on. When turning on the temperature sensor circuit after stopping access from MPU, secure the specified output voltage setup time.
- *3. Waiting time after finish of SVD2 sampling by MPU and until MPU access can start.

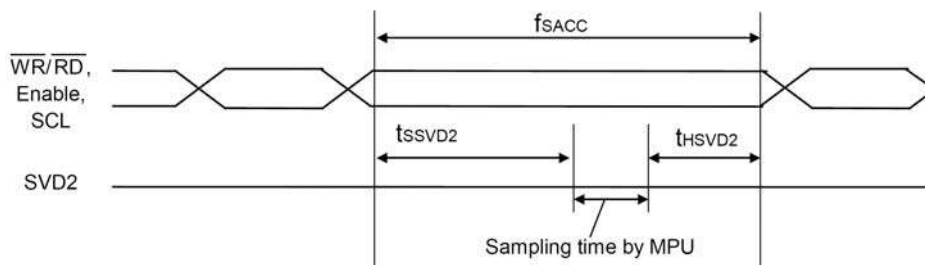

Figure 6: Temperature sensor measuring timing

6. LCD Specifications

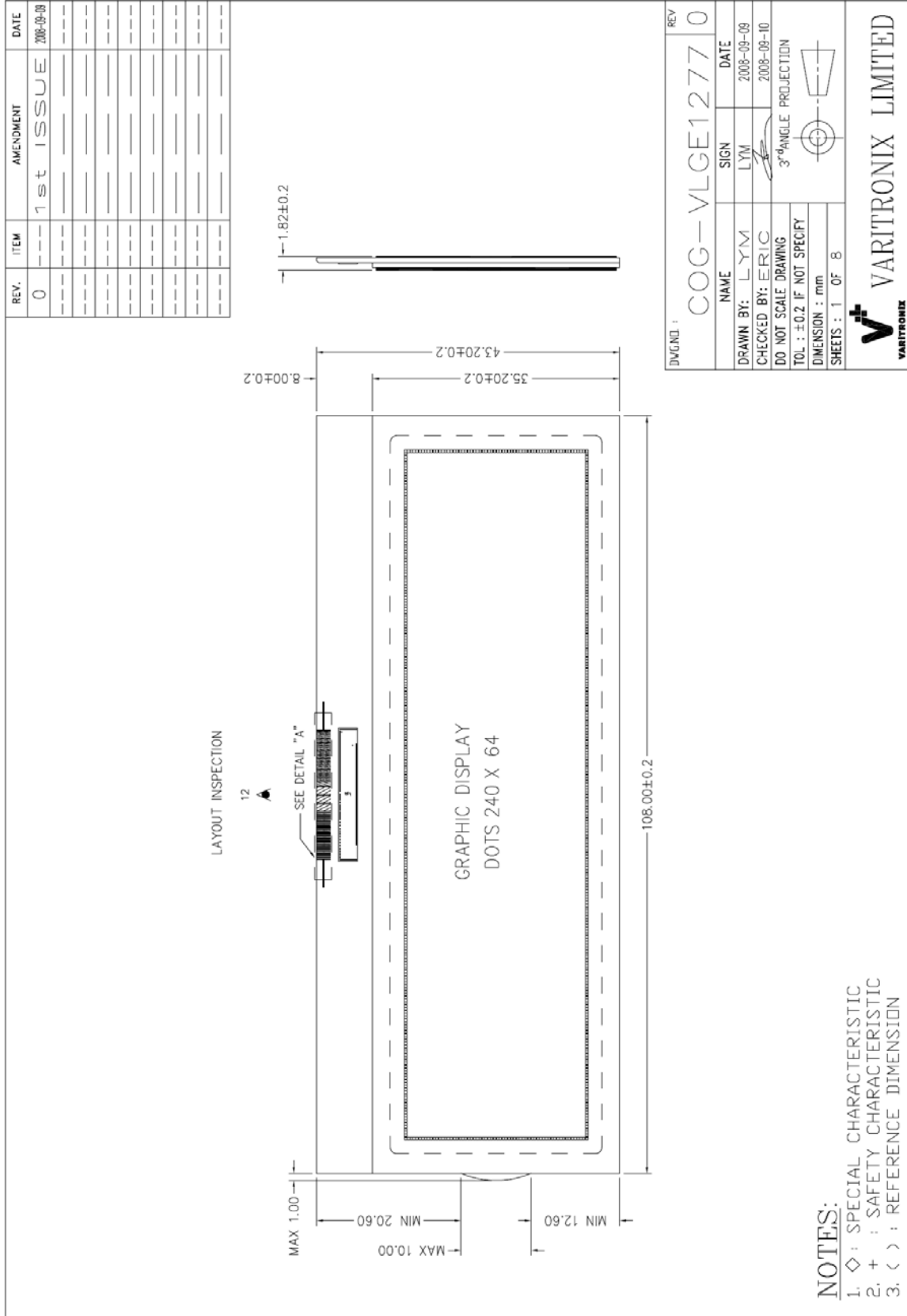
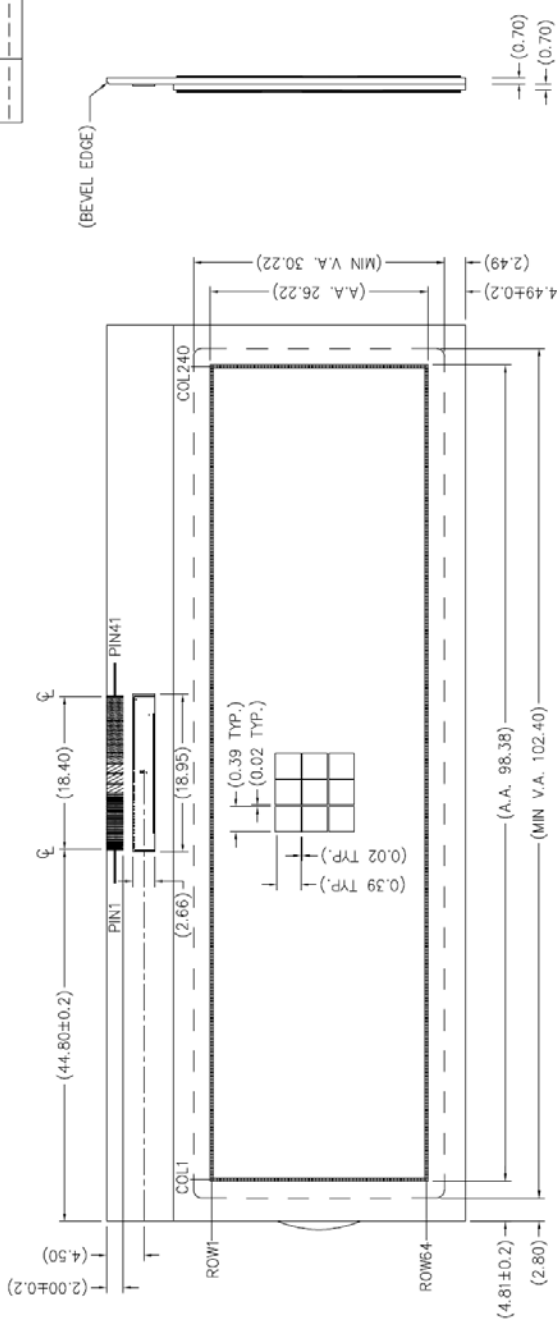

Figure 7: LCD drawing 1

REV.	ITEM	AMENDMENT	DATE
0		1st ISSUE	2008-09-10



DWG. NO. : COG-VLGE1277 0

NAME	SIGN	DATE
DRAWN BY: LYM	LYM	2008-09-09
CHECKED BY: ERIC		2008-09-10

DO NOT SCALE DRAWING
TOL : ±0.2 IF NOT SPECIFY
DIMENSION : mm
SHEETS : 2 OF 8

3° ANGLE PROJECTION



VARITRONIX LIMITED



- NOTES:**
- ◇ : SPECIAL CHARACTERISTIC
 - + : SAFETY CHARACTERISTIC
 - < > : REFERENCE DIMENSION

Figure 8: LCD drawing 2

REV.	ITEM	AMENDMENT	DATE
0	---	1st ISSUE	2008-09-09
---	---	---	---
---	---	---	---
---	---	---	---
---	---	---	---
---	---	---	---
---	---	---	---
---	---	---	---
---	---	---	---

SEGMENT TRACKING

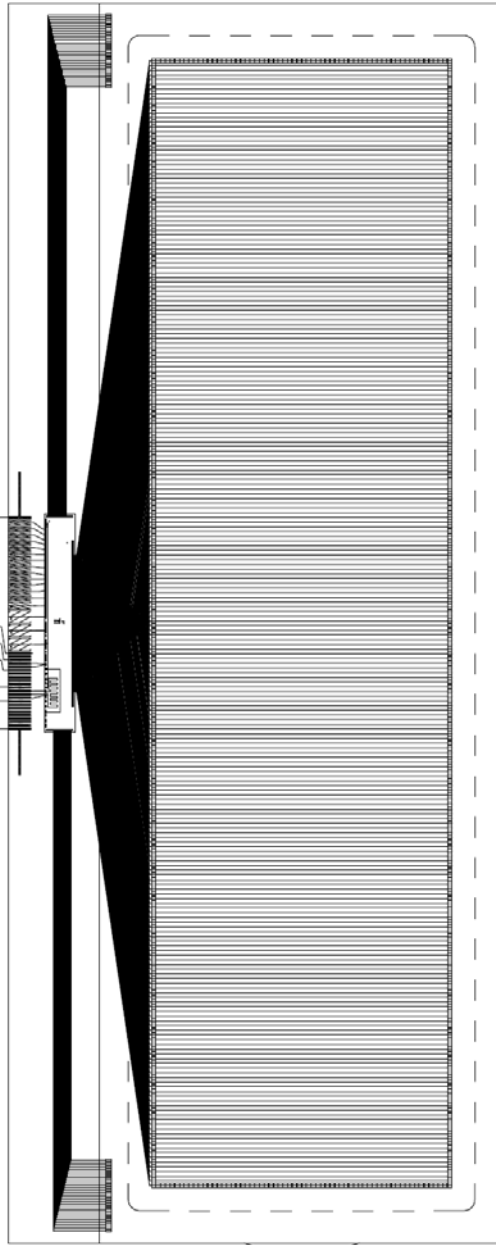
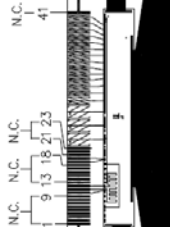

REMARKS: N.C. = NO CONNECTION

NOTES:

1. ◇ : SPECIAL CHARACTERISTIC
2. + : SAFETY CHARACTERISTIC
3. < > : REFERENCE DIMENSION



DWGNO. : COG-VLGE1277		REV 0	
NAME	SIGN	DATE	
DRAWN BY: LYM	LYM	2008-09-09	
CHECKED BY: ERIC		2008-09-10	
DO NOT SCALE DRAWING			
TOL : ±0.2 IF NOT SPECIFY			
DIMENSION : mm			
SHEETS : 5 OF 8			
 3 rd ANGLE PROJECTION			
 VARITRONIX LIMITED			



Figure 11: LCD drawing 5

REV.	ITEM	AMENDMENT	DATE
0	---	1st ISSUE	2008-09-09
---	---	---	---
---	---	---	---
---	---	---	---
---	---	---	---
---	---	---	---
---	---	---	---
---	---	---	---
---	---	---	---
---	---	---	---

COMMON TRACKING

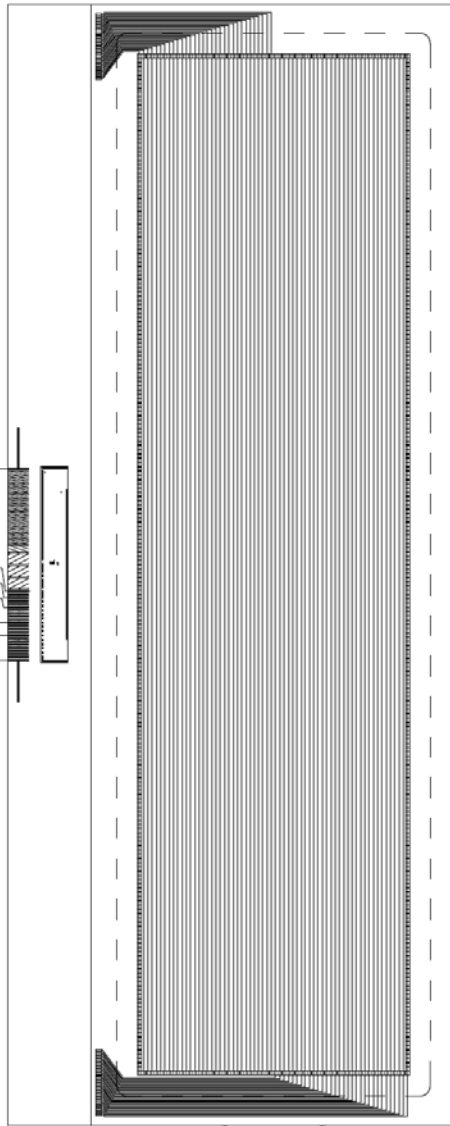
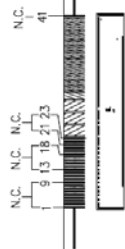

REMARKS: N.C. = NO CONNECTION

DWG. NO. : COG-VLGE1277 0		REV	
NAME	SIGN	DATE	
DRAWN BY: LYM	LYM	2008-09-09	
CHECKED BY: ERIC		2008-09-10	
DO NOT SCALE DRAWING		3 rd ANGLE PROJECTION	
TOL. : ±0.2 IF NOT SPECIFY			
DIMENSION : mm			
SHEETS : 6 OF 8			
		VARITRONIX LIMITED	

NOTES:

1. ◇ : SPECIAL CHARACTERISTIC
2. + : SAFETY CHARACTERISTIC
3. < > : REFERENCE DIMENSION

Figure 12: LCD drawing 6

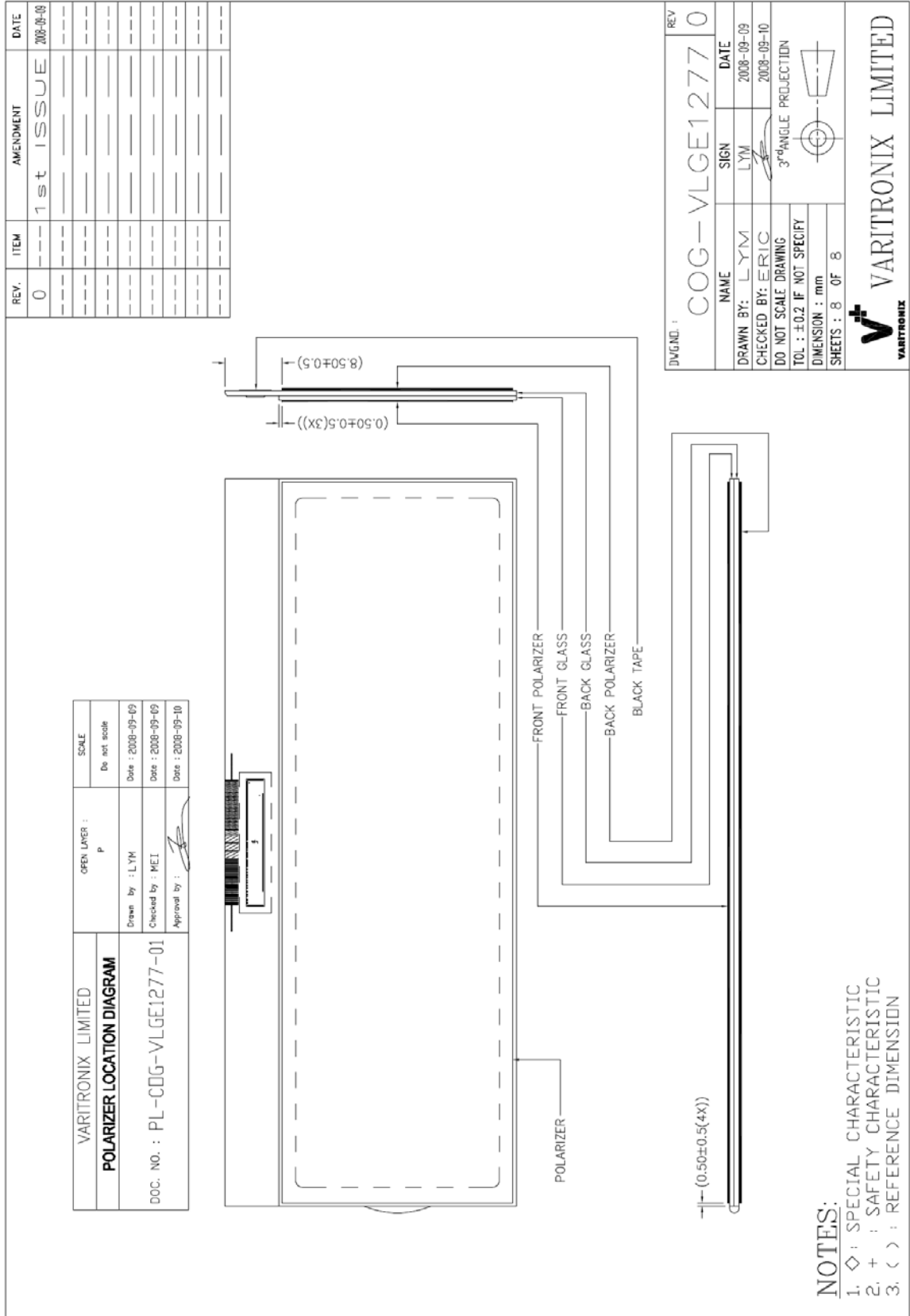

Figure 14: LCD drawing 8

7. Electro-Optical Characteristics

Table 9

Item	Symbol	Temp. °C	Value			Unit	Condition	
			Min.	Typ.	Max.			
Driving voltage	Vop	+25	-	10.5	-	V	Vop= optimum voltage	
Response time	Ton	+25	-	170	250	msec	Vop= Optimum voltage $\theta = 0^\circ, \phi = 0^\circ$	
	Toff		-	150	220			
Optimum viewing area Cr ≥ 4	$\theta 1$ (6 o'clock)	+25	7	15	-	DEG	$\phi = 0^\circ$	Vop= Optimum voltage (Remark 1)
	$\theta 2$ (12 o'clock)		20	28	-			
	$\phi 1$ (3 o'clock)		27	34	-		$\theta = 0^\circ$	
	$\phi 2$ (9 o'clock)		25	33	-			
Contrast ratio	Cr	+25	5	6	-	-	Vop = Optimum voltage $\theta = 0^\circ, \phi = 0^\circ$	

Remark 1: Due to hardware limitation, the maximum measurable angle is 50° .

7.1 Optical Characteristics Definition

a.) Viewing Angle

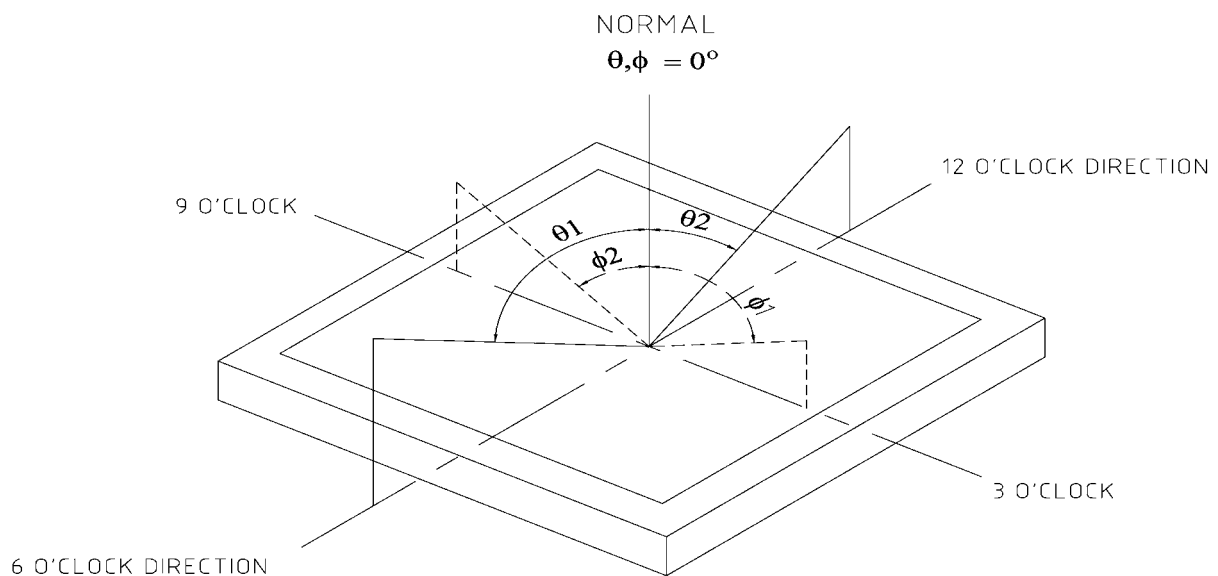

b.) Contrast Ratio

B1 = segments luminance in case of non-selected waveform

B2 = segments luminance in case of selected waveform

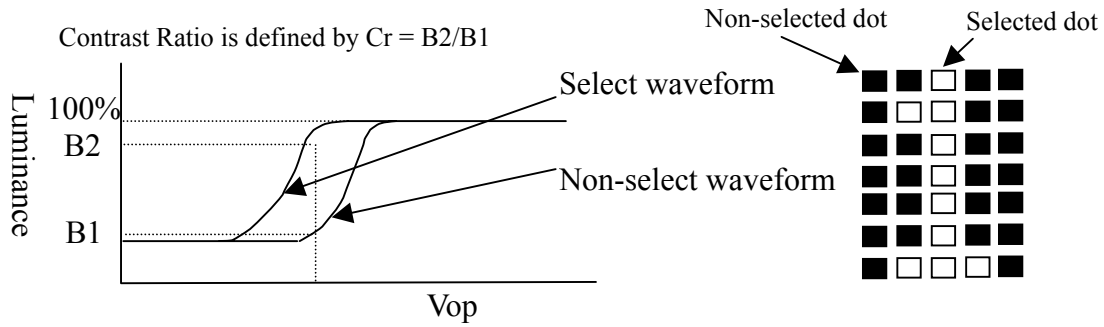

c.) Response Time

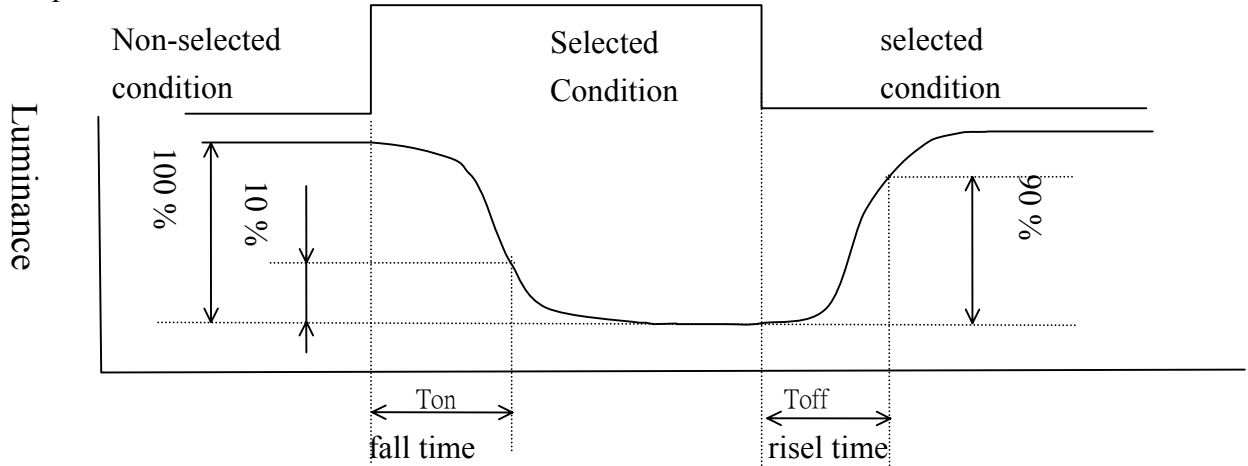

8. LCD Cosmetic Conditions

Refer to VL-QUA-012B.

Note: LCD size of the product is middle.

- 1.0 TITLE: Final QA Inspection for LCD Products(G2)
- 2.0 PURPOSE:
To define the final QA sampling inspection procedures and criteria for grade LCD.
- 3.0 SCOPE:
This document applies to mass production of all G2 LCD after electrical test and before polarizer sticking process, LCD final inspection and ready for final QA sampling inspection, except of those with special requirement from customer.
- 4.0 DEFINITION:
- 4.1 ZONE A: EAA: Effective Active Area
 ZONE B: EVA/VA: Viewing Area
 ZONE C: Outside EVA

4.2 Large Size (L), Middle Size(M), Small Size(S) are defined as below:

alignment	Mode	Large Size	Middle Size	Small size
7"*14"(7.5"*14")	+ve	1pc/laminate	2-6pcs/laminate	>6pcs/laminate
	-ve	<7pcs/laminate	7-15pcs/laminate	>15pcs/laminate
14"*16"	+ve	<15pcs/laminate	15-40pcs/laminate	>40pcs/laminate
	-ve	<20pcs/laminate	20-50pcs/laminate	>50pcs/laminate
14.5"*18.5"	+ve	<18pcs/laminate	18-45pcs/laminate	>45pcs/laminate
	-ve	<25pcs/laminate	25-55pcs/laminate	>55pcs/laminate

- 5.0 REFERENCE DOCUMENT:
- 5.1 VL-QUA-084A
 5.2 EI-WKL-980821-01
 5.3 EI-LT-980225-01

6.0 APPLICABLE EQUIPMENT:

6.1 LCD Tester

7.0 Definition of LCD parts:

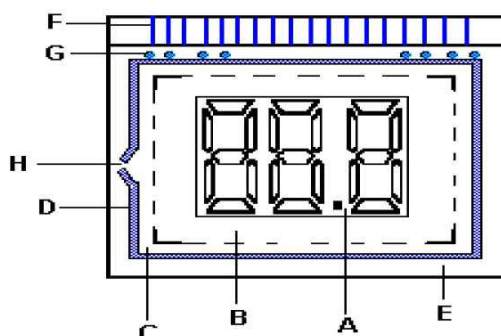

- A : Effective Activated Area
 B : Viewing Area
 C : Outside V.A.
 D : Perimeter Seal
 E : Out Perimeter Seal
 F : Contact Leads
 G : Silver Dot
 H : End Seal

7.2 Unless specified, LCD background color shall refer to standard color sample.

7.3 Inspection Specification:

7.3.1 Patterned glass inspection criterion:

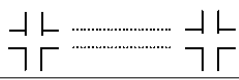
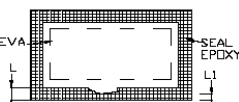
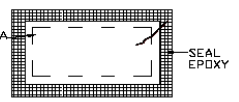
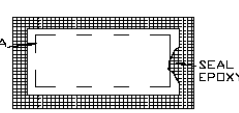
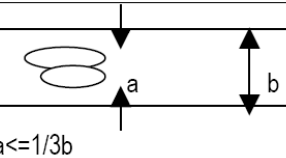
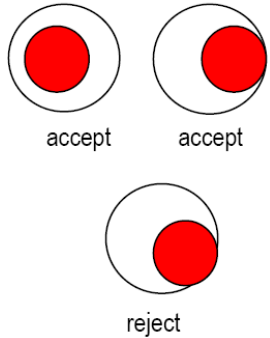

Defect Category	Defect Description	Scope	Criterion	Drawing Specification
Short	Photo-resist coated pattern connected	Patterned area	Not accept	
Open	Photo-resist coated pattern disconnected	Patterned area	Not accept	
Misalignment	Fish eyes misaligned	N/A	Not accept	
Pinhole	Pinhole on Photo-resist coating under sodium lamp	Patterned area	Not accept pinhole under sodium lamp with naked eyes	
Excess pattern	Excess Photo-resist	Patterned area	Not accept	
Missing pattern	Incomplete photo-resist	Patterned area	Not accept	
Rainbow	Uneven coating	ITO surface	Not accept colorific defect under sodium with naked eyes	
Black spot	Contaminated by foreign materials	Patterned area	Not accept foreign material under sodium lamp with unaided eyes	
Scratch	Scratch on glass surface	Patterned area	Not accept scratch on E.A.A	
Chip	Mechanical damage on glass edge or corner	Patterned area	Not accept damage on E.A.A	

7.3.2 Sodium Lamp Inspection Criteria

Defect Category	Defect Description	Zone	Criterion	Drawing Specification
Black spot/Foreign Materials	Foreign Material inside LC box	A,B,C,D	Newton Ring can't be found with unaided eyes under sodium lamp.	
Scratch	Scratch on glass surface	A,B,C,D	Scratch on EVA is not acceptable when it is observed under dark background with unaided eyes.	
Sealing problem	Sealing broken	D	Not accept	
	Wider sealing width	D	Sealing exceed scribing line is not accept. Refer to the drawing, sealing should not bleed into where between the two broken lines.	
	Narrow sealing width	D	Seal width narrowed to less than 2/3 of the normal width wherever on the display is not accepted. $L1 < 2/3 L$: reject	
	Distinct hairs going into the EVA through perimeter seal	D	Not accept	
	Seal epoxy bleeds into the EVA	D	Not accept	
	Bubble inside epoxy	D	Bubble diameter should $\leq 1/3$ seal width $a \leq 1/3 b$	
Bag broken	Vacuum bag broken	N/A	Reject when bag broken at STN or Self-short DOT type. No requirement for TN/HTN or silver dot type.	
Misalignment	Top & bottom fish eyes misaligned	N/A	Dot and circle shall not intersect.	

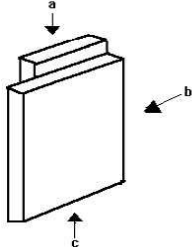
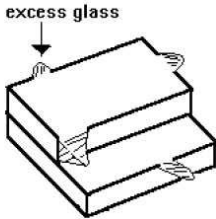
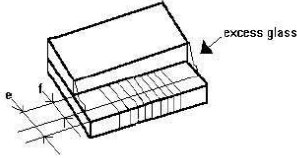
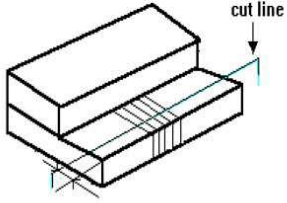
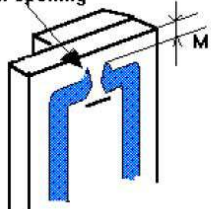
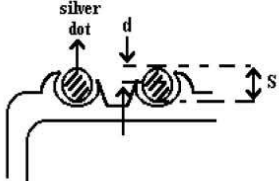
7.3.3 Criteria for Inspection after LC Filling:

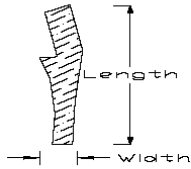
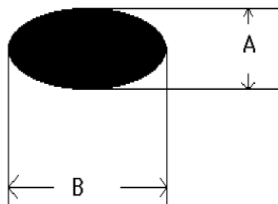
Defect Category	Defect Description	Zone	Criterion	Drawing Specification
Scribing defect	anomalous shape is observed on the edge viewing from direction a, b and c.	F,E	Shape shall be accordant with specification.	
	Excess glass within mechanical dimension.	F,E	Rework to remove the excess glass if possible.	
	Excess glass on contact lead	F	Accept if width of excess glass < 1/10 width of electrical contact area $f < 1/10 e$	 e = width of electrical contact area. f = width of excess glass.
	Scribing on contact leads	F	Cut line shall be according to specification	
	Wrong scribing	E	Accept if $M \leq 0\text{mm}$; M= distance between glass edge and seal opening;	
	Silver dot exposed	F,E	Acceptable if depth of exposure < 1/10 silver dot diameter $d < 1/10 S$	

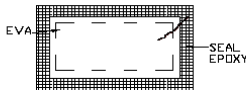
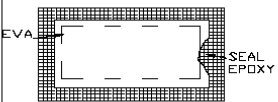
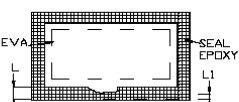
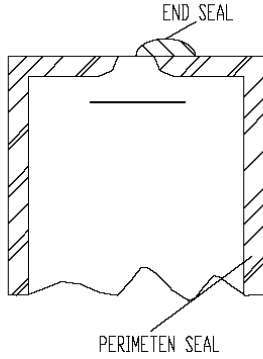
Defect Category	Defect Description	Zone	Criterion			Drawing Specification
Scratches	Scratches on glass surface	A,B	Length(mm)	Width_(mm)	Acc No.	
			/	<0.02	Any	
			<3.0	<0.03	2	
			<5.0	<0.05	1	
			/	>0.05	0	
Bubble	LC does not fulfill the box	A,B	(a) One or more bubble with D exceeds 0.2mm in diameter within EVA.			
		A,B,C,H	(b) Two or more bubbles with D 0.1mm to 0.2mm within the EVA.			
		(c) LCD is not accept if any bubble observed due to leakage of perimeter seal or end seal.				
Sealing Defect	White or color marks along the perimeter seal.	D	Not accept			
	Distinct hairs going into the EVA through the perimeter seal	A,B,C,D	Not accept			
	Seal epoxy bleeds into the EVA.	A,B,C,D	Not accept			
	Narrow seal width	D	Seal width narrowed to less than 2/3 normal width at any point of the display. L1 < 2/3 L : Reject			
	Color or hazy appearance neighboring to the end seal	H	Not accept			
	End seal epoxy does not entirely cover LC filling window.	H	Not accept			
	End seal depth exceed limit	H	Depth ≥ 0.2mm and shall not go into V.A.			

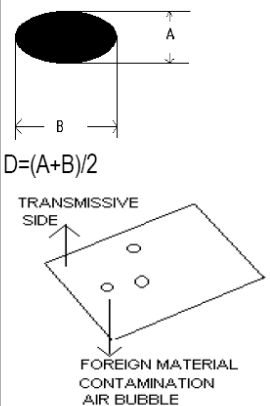
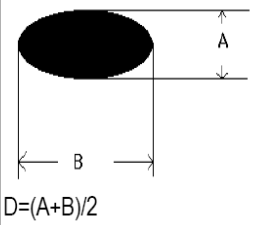
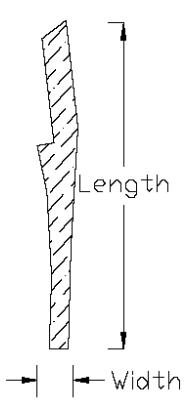
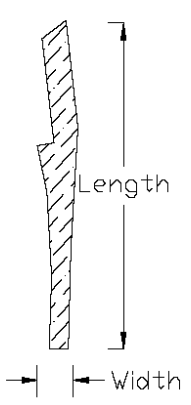
Defect Category	Defect Description	Zone	Criterion	Drawing Specification																														
Black spot/ Foreign Materials	Black spot, Foreign materials, Polarizer bubble, dent.	A	<p>Large size glass: Cosmetic defect can't be found at one meter distance to inspection and will not increase its size under electrical test.</p> <p>Middle size glass:</p> <table border="1"> <tr> <th>Diameter(mm)</th> <th>Acc No.</th> </tr> <tr> <td>$D \leq 0.1$</td> <td>Any</td> </tr> <tr> <td>$0.10 < D \leq 0.20$</td> <td>2</td> </tr> <tr> <td>$0.20 < D \leq 0.30$</td> <td>1</td> </tr> <tr> <td>$0.30 < D$</td> <td>0</td> </tr> </table> <p>Small size glass:</p> <table border="1"> <tr> <th>Diameter(mm)</th> <th>Acc No.</th> </tr> <tr> <td>$D \leq 0.10$</td> <td>Any</td> </tr> <tr> <td>$0.10 < D \leq 0.20$</td> <td>1</td> </tr> <tr> <td>$D > 0.20$</td> <td>0</td> </tr> </table>	Diameter(mm)	Acc No.	$D \leq 0.1$	Any	$0.10 < D \leq 0.20$	2	$0.20 < D \leq 0.30$	1	$0.30 < D$	0	Diameter(mm)	Acc No.	$D \leq 0.10$	Any	$0.10 < D \leq 0.20$	1	$D > 0.20$	0													
		Diameter(mm)	Acc No.																															
		$D \leq 0.1$	Any																															
$0.10 < D \leq 0.20$	2																																	
$0.20 < D \leq 0.30$	1																																	
$0.30 < D$	0																																	
Diameter(mm)	Acc No.																																	
$D \leq 0.10$	Any																																	
$0.10 < D \leq 0.20$	1																																	
$D > 0.20$	0																																	
B	1.5 times of acceptable largest diameter size of Zone A																																	
C	Accept any quantity and size except voids and reverse twist. But the reverse twist can be accept if it happened in zone c without PI coat.																																	
White spot(for -ve mode)		A	<p>Large size :</p> <table border="1"> <tr> <th>Diameter (mm)</th> <th>Acc No.</th> </tr> <tr> <td>$D \leq 0.2$</td> <td>Any</td> </tr> <tr> <td>$0.2 < D \leq 0.25$</td> <td>2</td> </tr> <tr> <td>$0.25 < D \leq 0.3$</td> <td>1</td> </tr> <tr> <td>$0.3 < D$</td> <td>0</td> </tr> </table> <p>Middle size :</p> <table border="1"> <tr> <th>Diameter (mm)</th> <th>Acc No.</th> </tr> <tr> <td>$D \leq 0.15$</td> <td>Any</td> </tr> <tr> <td>$0.15 < D \leq 0.2$</td> <td>2</td> </tr> <tr> <td>$0.2 < D \leq 0.25$</td> <td>1</td> </tr> <tr> <td>$0.25 < D$</td> <td>0</td> </tr> </table> <p>Small size :</p> <table border="1"> <tr> <th>Diameter (mm)</th> <th>Acc No.</th> </tr> <tr> <td>$D \leq 0.1$</td> <td>Any</td> </tr> <tr> <td>$0.1 < D \leq 0.15$</td> <td>2</td> </tr> <tr> <td>$0.15 < D \leq 0.2$</td> <td>1</td> </tr> <tr> <td>$0.2 < D$</td> <td>0</td> </tr> </table>	Diameter (mm)	Acc No.	$D \leq 0.2$	Any	$0.2 < D \leq 0.25$	2	$0.25 < D \leq 0.3$	1	$0.3 < D$	0	Diameter (mm)	Acc No.	$D \leq 0.15$	Any	$0.15 < D \leq 0.2$	2	$0.2 < D \leq 0.25$	1	$0.25 < D$	0	Diameter (mm)	Acc No.	$D \leq 0.1$	Any	$0.1 < D \leq 0.15$	2	$0.15 < D \leq 0.2$	1	$0.2 < D$	0	
		Diameter (mm)	Acc No.																															
		$D \leq 0.2$	Any																															
$0.2 < D \leq 0.25$	2																																	
$0.25 < D \leq 0.3$	1																																	
$0.3 < D$	0																																	
Diameter (mm)	Acc No.																																	
$D \leq 0.15$	Any																																	
$0.15 < D \leq 0.2$	2																																	
$0.2 < D \leq 0.25$	1																																	
$0.25 < D$	0																																	
Diameter (mm)	Acc No.																																	
$D \leq 0.1$	Any																																	
$0.1 < D \leq 0.15$	2																																	
$0.15 < D \leq 0.2$	1																																	
$0.2 < D$	0																																	
B	1.5 times of acceptable largest diameter size of Zone A																																	
C	Accept any quantity and size except voids and reverse twist. But the reverse twist can be accept if it happened in zone c without PI coat.																																	
Lines, hairs		A,	<table border="1"> <tr> <th>Length(mm)</th> <th>Width(mm)</th> <th>Acc No./cm2</th> </tr> <tr> <td>Any length</td> <td>≤ 0.01</td> <td>Any</td> </tr> <tr> <td></td> <td>≤ 2.0</td> <td>2</td> </tr> <tr> <td></td> <td>≤ 3.0</td> <td>1</td> </tr> <tr> <td>Any length</td> <td>> 0.03</td> <td>0</td> </tr> </table> <p>(Applicable to all glasses with different area)</p>	Length(mm)	Width(mm)	Acc No./cm2	Any length	≤ 0.01	Any		≤ 2.0	2		≤ 3.0	1	Any length	> 0.03	0																
		Length(mm)	Width(mm)	Acc No./cm2																														
		Any length	≤ 0.01	Any																														
	≤ 2.0	2																																
	≤ 3.0	1																																
Any length	> 0.03	0																																
B	1.5 times of acceptable largest diameter size of Zone A																																	
C	Accept any quantity and size except voids and reverse twist. But the reverse twist can be accept if it happened in zone c without PI coat.																																	
Lines, hairs(for-ve model)		A	<table border="1"> <tr> <th>Length(mm)</th> <th>Width(mm)</th> <th>Acc No./cm2</th> </tr> <tr> <td>Any length</td> <td>≤ 0.01</td> <td>Any</td> </tr> <tr> <td></td> <td>≤ 2.0</td> <td>1</td> </tr> <tr> <td>Any length</td> <td>> 0.02</td> <td>0</td> </tr> </table>	Length(mm)	Width(mm)	Acc No./cm2	Any length	≤ 0.01	Any		≤ 2.0	1	Any length	> 0.02	0																			
		Length(mm)	Width(mm)	Acc No./cm2																														
		Any length	≤ 0.01	Any																														
	≤ 2.0	1																																
Any length	> 0.02	0																																
B	<table border="1"> <tr> <th>Length(mm)</th> <th>Width(mm)</th> <th>Acc No./cm2</th> </tr> <tr> <td>Any length</td> <td>≤ 0.01</td> <td>Any</td> </tr> <tr> <td></td> <td>≤ 3.0</td> <td>1</td> </tr> <tr> <td>Any length</td> <td>> 0.02</td> <td>0</td> </tr> </table>	Length(mm)	Width(mm)	Acc No./cm2	Any length	≤ 0.01	Any		≤ 3.0	1	Any length	> 0.02	0																					
Length(mm)	Width(mm)	Acc No./cm2																																
Any length	≤ 0.01	Any																																
	≤ 3.0	1																																
Any length	> 0.02	0																																
C	Accept any quantity and size except voids and reverse twist. But the reverse twist can be accept if it happened in zone c without PI coat.																																	

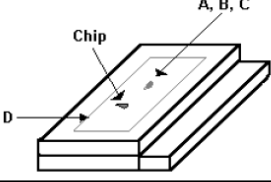
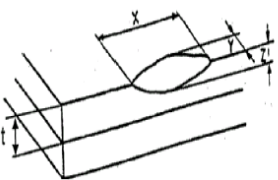
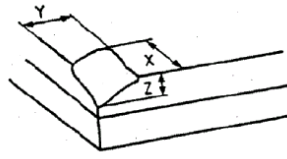
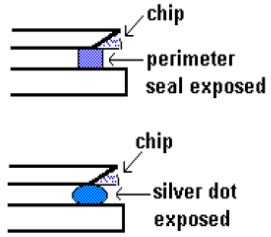
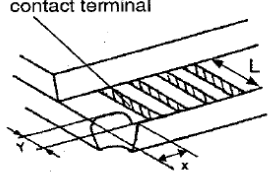

Remark: 1. All above black spot/ foreign material defects min. space shall be $\geq 20\text{mm}$.

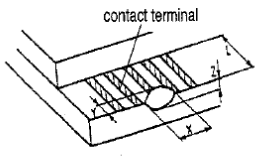
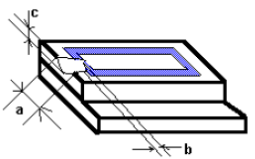
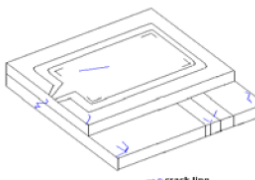
Defect Category	Defect Description	Zone	Criterion	Drawing Specification
Rainbow	Arches, circular or parallel colorful spread observed	A,B	Refer to golden sample	
Fingerprint	Fingerprint on PI coating	A,B	Not accept any fingerprint	
PI scrape	PI scraped	A,B	Refer to above Black spot/ Foreign Materials criterion	
Reverse twist	Visible radialized spot	A,B,C	Not accept	
Mechanical Damage	Chip on surface/ side/ corner/ perimeter seal/ silver dot	A,B,C	Not accept any chip	
		D,E	When $Z < 3/4$ glass thickness 1- $X \leq 3\text{mm}$; 2- $Y \leq 1/2$ perimeter seal width. When $Z \geq 3/4$ glass thickness 2- $X \leq 2\text{mm}$; 3- $Y < 1/3$ perimeter seal width.. Note: If glass thickness $< 0.7\text{mm}$, accept $Z = \text{glass thickness}$	
			Same as above spec.	
		D,G	1- The silver dot can not be exposed. 2- more than 50% of sealing frame must remain,	
	Chips on ledge, but not on ITO trace	F	When $Z < 1/2$ glass thickness: 1- $X \leq 5\text{mm}$; 2- $Y \leq \text{length of ledge}$ When $Z \geq 1/2$ glass thickness: 1- $X \leq 2\text{mm}$; 2- $Y \leq 1/3$ length of ledge. Note: If glass thickness $< 0.7\text{mm}$, accept $Z = \text{glass thickness}$	

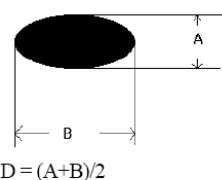
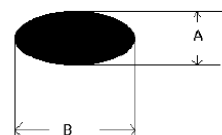
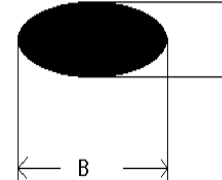
Defect Category	Defect Description	Zone	Criterion	Drawing Specification
Mechanical Damage	Chip on ledge with ITO side (for pin & COG model)	F	1- $X \leq 1/2$ width of single ITO 2- $Y < 1/10$ length of ledge 3- $Z < 1/10$ glass thickness Whichever out of spec is not accept.	 <p>This drawing only for with ITO side</p>
	Chip on ledge with ITO side (for Non pin & COG model)	F	When $Z < 1/2$ glass thickness: 1- $X \leq 3\text{mm}$; 2- $Y \leq 1/4$ length of ledge. When $Z \geq 1/2$ glass thickness: 1- $X \leq 2\text{mm}$; 2- $Y \leq 1/4$ length of ledge/4. Note: If glass thickness $< 0.7\text{mm}$, accept $Z = \text{glass thickness}$	
	Chip on ledge without ITO side (for pin & COG model)	F	When $Z < 1/2$ glass thickness: 1- $X \leq 5\text{mm}$; 2- $Y \leq 1/4$ length of ledge. When $Z \geq 1/2$ glass thickness: 1- $X \leq 2\text{mm}$; 2- $Y \leq 1/4$ length of ledge/4. Note: If glass thickness $< 0.7\text{mm}$, accept $Z = \text{glass thickness}$	
	Chip on ledge without ITO side (for Non pin & COG model)	F	When $Z < 3/4$ glass thickness: 1- $X \leq 5\text{mm}$; 2- $Y \leq 1/4$ length of ledge. When $Z \geq 3/4$ glass thickness: 1- $X \leq 2\text{mm}$; 2- $Y \leq 1/4$ length of ledge/4. Note: If glass thickness $< 0.7\text{mm}$, accept $Z = \text{glass thickness}$	
	Chip on end seal	H	Any chip can not be accept	
	Crack	A,B,C,D,E,F,G,H	Inspector shall attempt to remove the chip with tweezers. Re-evaluate if the remaining defect is still a crack or a chip. Reject chip or crack of any size in EVA.	

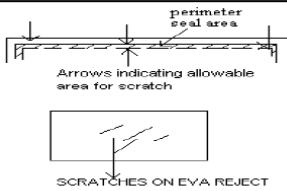
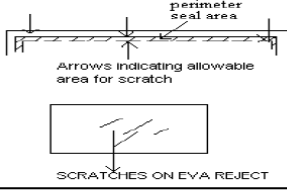
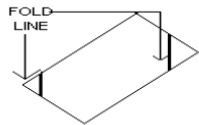
Defect Category	Defect Description	Zone	Criterion	Drawing Specification
Ink-Printing defect	Glass chip or foreign material affix on ink of glass surface and can't be wiped away;	A,B	If find out of ink pattern. can scrape away by using blade but can't accept any light leakage (refer to definition of light leakage); If find dirt within ink pattern: <u>diameter (D)</u> <u>accepted QTY</u> D ≤ 0.1mm any 0.1 < D ≤ 0.2mm 1 D > 0.2mm 0	 D = (A+B)/2
	Ink line/ pattern broken;	A,B	Can't accept	
	Light leakage: When activated with current white light appears in the position of pinhole or scratch due to ink printing misalignment	A,B	Can't accept any light leakage due to misalignment. For light leakage of pinhole: <u>diameter (D)</u> <u>accepted QTY</u> D ≤ 0.1mm any 0.1 < D ≤ 0.2mm 1 D > 0.2mm 0	
	Ink misalignment The position of the ink shift.	A,B,C,D,E,F,G,H	Accept if the shift is within the tolerance and dimension specified in drawing. Unless otherwise specified, tolerance of ink printing shift should be ±0.5mm	
	Thick or thin ink. Ink line/pattern are thicker or thinner than that specified in the drawing	A,B,C	(a) Accept if thick or thin part is less than 10% or ≤ 0.15mm. (b) Reject if thick or thin part is more than 10% or ≥ 0.15mm Thick part outside EVA can be removed with blade and the one inside EVA is not acceptable.	
	Ink pattern or lines jagged	A,B	(a) Accept if thick or thin part is less than 10% or ≤ 0.15mm. (c) Reject if thick or thin part is more than 10% or ≥ 0.15mm	
	Uneven ink. Ink darker or lighter	A,B	Reject if darker or lighter than the color of sample	
	Dilapidation. Mesh with dilapidation results in leakage of ink and form dots on the glass that can't be removed with blade.	A,B	<u>Spot:</u> <u>Diameter</u> <u>Acc No.</u> D ≤ 0.1mm Any 0.1 < D ≤ 0.2mm 1 D > 0.2mm 0	 D = (A+B)/2
Date code defect	Date code defect of printed pattern: wrong pattern, fuzzy pattern, misalignment	Printed area	Not accept any wrong pattern and misalignment. Not accept any fuzzy pattern being difficult to identify. Pls. Refer to limit sample if there is.	

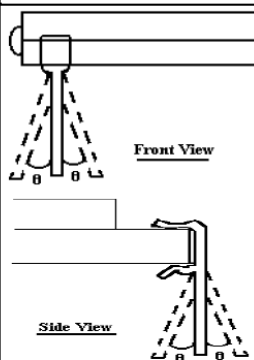
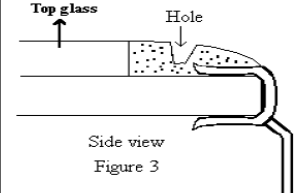
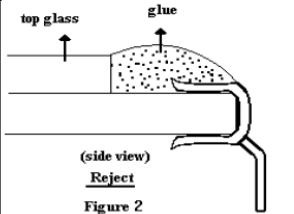

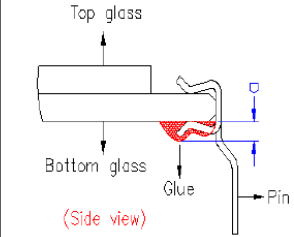
Defect Category	Defect Description	Zone	Criterion	Drawing Specification
Polarizer defect	Scratch on transmissive polarizer	A,B	Reject if scratch inside VA	
	Scratch on transmissive polarizer	A,B	Reject if scratch inside VA	
	Scratch on reflective polarizer	A,B,C	Accepted scratch length : < 2.0mm, two scratches are allowed on reflective side. Accept if scratch could not be found when viewing on top of transmissive polarizer.	
	Scratch on transfective polarizer	A,B,C	Unacceptable if scratch observed with front light.	
	Folded line	A,B	Not accept on transmissive polarizer. Invisible fold on transfective or reflective polarizer is acceptable.	
	Mechanical damage	A,B	Not accept, i.e. dent or pinhole	
		C	Minor dint is acceptable. Serious dent like pinhole can not be accept.	
	Discoloration	A,B,C	Any discoloration can not be accept	
	Wrong or reversed polarizer	N/A	Not accept	
	Polarizer shift or protrude from the edge of glass	N/A	1-Polarizer protruding can not be accept 2-When polarizer position shift but still within perimeter sealed area , it is rejected if perimeter seal underneath is partially covered. 3- When polarizer position shift but still within perimeter sealed area , it is accepted if perimeter seal underneath could be perfectly seen.	
Any peeling or delamination of polarizer	N/A	Not accept		
Polarizer type not conform to the product specification	N/A	Not accept		
Polarizer protecting film missing	N/A	Not accept. (unless requested by customer)		

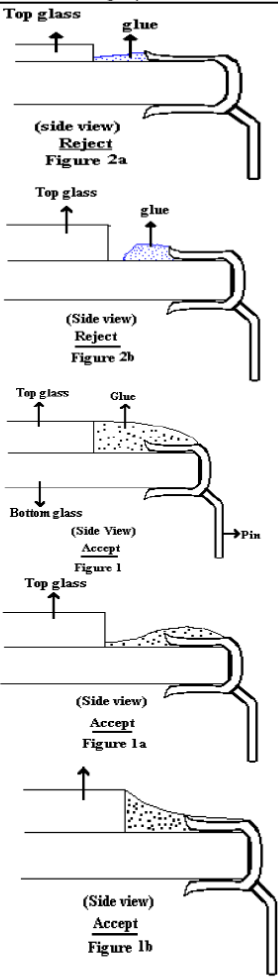
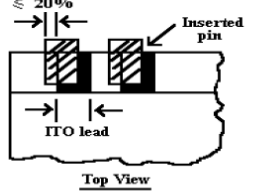
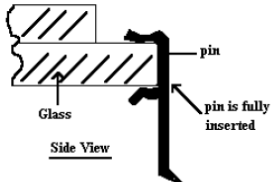
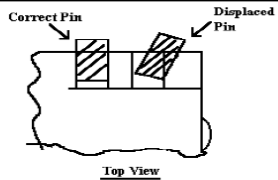
Defect Category	Defect Description	Zone	Criterion	Drawing Specification
Pin attachment defect	Pin incoming defect : Oxidized , damaged(including pins plating damaged)	N/A	Not accept	
	Distorted pins	N/A	Distorted angle shall $\leq 5^\circ$ $\theta \leq 5^\circ$	 <p>Front View Side View</p>
	Pin epoxy cracked	N/A	Hole alike the figure can not be accept	 <p>Top glass Hole Side view Figure 3</p>
	Pin epoxy be over the top polarizer surface	N/A	Not accept	 <p>top glass glue (side view) Reject Figure 2</p>
	Pin epoxy that flows onto pins	N/A	Not accept if epoxy found at arrow indicated area	
	Epoxy on polarizer	N/A	Not accept	
	Excess glue on bottom glass	N/A	Reject if the thickness of bottom epoxy more than 1.0mm. If $D > 1.0\text{mm}$, it should be reject.	 <p>Top glass Bottom glass Glue Pin (Side view)</p>

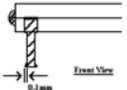
Defect Category	Defect Description	Zone	Criterion	Drawing Specification
Pin attachment defect	UV epoxy defect deficient on pins	N/A	Vertical fill of UV epoxy shall be sufficient to cover the pins. Case like Figure 2a, 2b are rejected, Figure 1, 1a, 1b are accepted.	 <p>Top glass glue (side view) Reject Figure 2a</p> <p>Top glass glue (Side view) Reject Figure 2b</p> <p>Top glass Glue Bottom glass (Side View) Accept Figure 1</p> <p>Top glass (Side view) Accept Figure 1a</p> <p>(Side view) Accept Figure 1b</p>
	Pins overhang .Pin located out of designed position	N/A	Pins must be on ITO leads, no pins missing is allowed. Pins' side overhang shall less than 20% ITO lead width	 <p>≤ 20% Inserted pin ITO lead Top View</p>
	Pin is not well contacted with ITO leads	N/A	Pins should be fully inserted on the glass	 <p>Glass pin pin is fully inserted Side View</p>
	Pin displaced	N/A	Displacement like drawing is not accepted	 <p>Correct Pin Displaced Pin Top View</p>
Defective pin	Incorrect pin length	N/A	Pin length that not conform to the product specification can not be accept.	

Defect Category	Defect Description	Zone	Criterion	Drawing Specification
Defective pin	Burr	N/A	Reject if loose burs >0.1mm at the tip of pins	
	Incorrect pins quantity	N/A	More or less pins are not accepted	
	Pin bending does not meet specification	N/A	Reject if no bending or bending not meet spec (only applicable to where pin bending is required)	

7.3.4 Criterion for Functional Test after LC Filling :

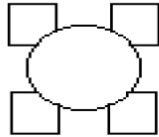
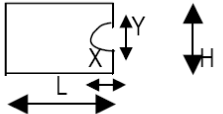
Defect Category	Defect Description	Zone	Criterion	Drawing Specification																														
Fake zero	Black dot/spot fade out at activated state		Refer to the spot and lines spec.																															
Black spot/ Pinhole at activated state	white spot at activated state.(for negative mode)	A	<p>Large size :</p> <table border="1"> <tr> <th>Diameter (mm)</th> <th>Acc No.</th> </tr> <tr> <td>$D \leq 0.2$</td> <td>Any</td> </tr> <tr> <td>$0.2 < D \leq 0.25$</td> <td>2</td> </tr> <tr> <td>$0.25 < D \leq 0.3$</td> <td>1</td> </tr> <tr> <td>$0.3 < D$</td> <td>0</td> </tr> </table> <p>Middle size :</p> <table border="1"> <tr> <th>Diameter (mm)</th> <th>Acc No.</th> </tr> <tr> <td>$D \leq 0.15$</td> <td>Any</td> </tr> <tr> <td>$0.15 < D \leq 0.2$</td> <td>2</td> </tr> <tr> <td>$0.2 < D \leq 0.25$</td> <td>1</td> </tr> <tr> <td>$0.25 < D$</td> <td>0</td> </tr> </table> <p>Small size :</p> <table border="1"> <tr> <th>Diameter (mm)</th> <th>Acc No.</th> </tr> <tr> <td>$D \leq 0.1$</td> <td>Any</td> </tr> <tr> <td>$0.1 < D \leq 0.15$</td> <td>2</td> </tr> <tr> <td>$0.15 < D \leq 0.2$</td> <td>1</td> </tr> <tr> <td>$0.2 < D$</td> <td>0</td> </tr> </table>	Diameter (mm)	Acc No.	$D \leq 0.2$	Any	$0.2 < D \leq 0.25$	2	$0.25 < D \leq 0.3$	1	$0.3 < D$	0	Diameter (mm)	Acc No.	$D \leq 0.15$	Any	$0.15 < D \leq 0.2$	2	$0.2 < D \leq 0.25$	1	$0.25 < D$	0	Diameter (mm)	Acc No.	$D \leq 0.1$	Any	$0.1 < D \leq 0.15$	2	$0.15 < D \leq 0.2$	1	$0.2 < D$	0	 white spot  black (dark) spot  
		Diameter (mm)	Acc No.																															
		$D \leq 0.2$	Any																															
$0.2 < D \leq 0.25$	2																																	
$0.25 < D \leq 0.3$	1																																	
$0.3 < D$	0																																	
Diameter (mm)	Acc No.																																	
$D \leq 0.15$	Any																																	
$0.15 < D \leq 0.2$	2																																	
$0.2 < D \leq 0.25$	1																																	
$0.25 < D$	0																																	
Diameter (mm)	Acc No.																																	
$D \leq 0.1$	Any																																	
$0.1 < D \leq 0.15$	2																																	
$0.15 < D \leq 0.2$	1																																	
$0.2 < D$	0																																	
		B	1.5 times of acceptable largest diameter size of Zone A																															
		C	Accept any quantity and size except voids and reverse twist. But the reverse twist can be accept if it happened in zone c without PI coat.																															
	black spot / pin hole at activated state. (for positive mode)	A	<p>Large size :</p> <table border="1"> <tr> <th>Diameter (mm)</th> <th>Acc No.</th> </tr> <tr> <td>$D \leq 0.15$</td> <td>Any</td> </tr> <tr> <td>$0.15 < D \leq 0.3$</td> <td>5</td> </tr> <tr> <td>$0.3 < D \leq 0.4$</td> <td>2</td> </tr> <tr> <td>$0.4 < D$</td> <td>0</td> </tr> </table> <p>Middle size :</p> <table border="1"> <tr> <th>Diameter (mm)</th> <th>Acc No.</th> </tr> <tr> <td>$D \leq 0.1$</td> <td>Any</td> </tr> <tr> <td>$0.1 < D \leq 0.2$</td> <td>2</td> </tr> <tr> <td>$0.2 < D \leq 0.3$</td> <td>1</td> </tr> <tr> <td>$0.3 < D$</td> <td>0</td> </tr> </table> <p>Small size :</p> <table border="1"> <tr> <th>Diameter (mm)</th> <th>Acc No.</th> </tr> <tr> <td>$D \leq 0.1$</td> <td>Any</td> </tr> <tr> <td>$0.1 < D \leq 0.2$</td> <td>1</td> </tr> <tr> <td>$0.2 < D$</td> <td>0</td> </tr> </table>	Diameter (mm)	Acc No.	$D \leq 0.15$	Any	$0.15 < D \leq 0.3$	5	$0.3 < D \leq 0.4$	2	$0.4 < D$	0	Diameter (mm)	Acc No.	$D \leq 0.1$	Any	$0.1 < D \leq 0.2$	2	$0.2 < D \leq 0.3$	1	$0.3 < D$	0	Diameter (mm)	Acc No.	$D \leq 0.1$	Any	$0.1 < D \leq 0.2$	1	$0.2 < D$	0			
		Diameter (mm)	Acc No.																															
		$D \leq 0.15$	Any																															
$0.15 < D \leq 0.3$	5																																	
$0.3 < D \leq 0.4$	2																																	
$0.4 < D$	0																																	
Diameter (mm)	Acc No.																																	
$D \leq 0.1$	Any																																	
$0.1 < D \leq 0.2$	2																																	
$0.2 < D \leq 0.3$	1																																	
$0.3 < D$	0																																	
Diameter (mm)	Acc No.																																	
$D \leq 0.1$	Any																																	
$0.1 < D \leq 0.2$	1																																	
$0.2 < D$	0																																	
		B	1.5 times of acceptable largest diameter size of Zone A																															
		C	Accept any quantity and size except voids and reverse twist. But the reverse twist can be accept if it happened in zone c without PI coat.																															
	Dot Matrix	A	Dot matrix pinhole size must meet X and $Y \leq 2/3L, H$ or $\leq 0.2\text{mm}$, whichever is greater																															

Remark: 1. All above black spot/ foreign material defects min. space shall be $\geq 20\text{mm}$.

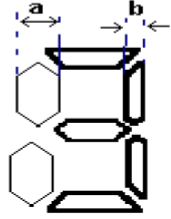
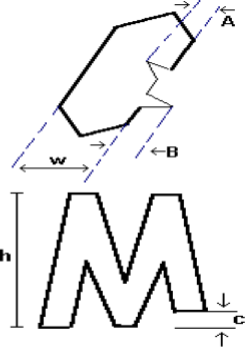
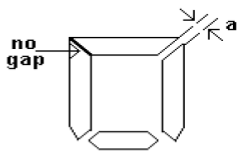
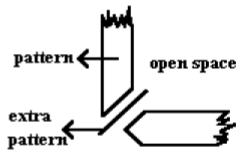
Defect Category	Defect Description	Zone	Criterion	Drawing Specification
COMMON open	Part or all pattern do not light up	N/A	Not accept	
SEGMENT open	One or few pattern segment does not light up	N/A	Not accept	
Pattern deformation	Segment fatter or smaller	N/A	Segment fatter than 110% or smaller than 90% of the designed value. Reject: $ (a-b) / b \geq 10\%$	
	Pattern deformation	N/A	Missing pattern or extra pattern >0.1mm, or >20% designed pattern width is unacceptable Reject: A or B > 0.1mm $(A \text{ or } B) / W > 20\%$ Missing pattern or extra pattern >0.2mm or >1/8 designed height is unacceptable. Reject: C > 0.2mm $C > 1/8 H$	
	The gap width between patterns out of limit	N/A	Reject: $a < 0.1\text{mm}$ $a > 0.3\text{mm}$	
COM-COM short	Black line between segments.	N/A	Accept if invisible at 30cm distance. For game application, the excess black line is acceptable if it does not affect the visibility.	
SEG-SEG short	COM and COM connected	N/A	Not accept	
COM-SEG short	SEG and SEG connected	N/A	Not accept	
	COM and SEG connected	N/A	Not accept	
Darker/Lighter	Pattern darker or lighter than standard sample at activated state.	N/A	Refer to standard or limit sample	
High current	Current exceed designed value	N/A	When power on, the pointer of short-circuit tester swing to MAX and then back, while the indicator lights up then goes out	
Black & white mark/bevel wave	Black & white mark or spraying/bevel wave etc. at activated state	N/A	Refer to standard or limit sample	
Black & white Line	Black & white line at activated state	N/A	Refer to above related black&white line criteria on cosmetic defect	



9. Remark

HANDLING LCD AND LCD MODULES

1. Liquid Crystal Display (LCD)

LCD is made up of glass, organic sealant, organic fluid and polymer based polarizers. The following precautions should be taken when handling:

- (1) Keep the temperature within range for use and storage. Excessive temperature and humidity could cause polarization degradation, polarizer peel-off or bubble generation. When storage for a long period over 40° C is required, the relative humidity should be kept below 60%.
- (2) Do not contact the exposed polarizers with anything harder than an HB pencil lead. To clean dust off the display surface, wipe gently with cotton, chamois or other soft material soaked in petroleum benzin. Never scrub hard.
- (3) Varitronix does not responsible for any polarizer defect after the protective film has been removed from the display
- (4) Wipe off saliva or water drops immediately. Contact with water over a long period of time may cause polarizer deformation or color fading, while an active LCD with water condensation on its surface will cause corrosion of ITO electrodes.
- (5) PETROLEUM BENZIN is recommended to remove adhesives used to attach front/rear polarizers and reflectors, while chemicals like acetone, toluene, ethanol and isopropyl alcohol will cause damage to the polarizer. Avoid oil and fats. Avoid lacquer and epoxies which might contain solvents and hardeners to cause electrode erosion. Some solvents will also soften the epoxy covering the DIL pins and thereby weakening the adhesion of the epoxy on glass. This will cause the exposed electrodes to erode electrochemically when operating in high humidity and condensing environment.
- (6) Glass can be easily chipped or cracked from rough handling, especially at corners and edges.
- (7) Do not drive LCD with DC voltage.
- (8) When soldering DIL pins, avoid excessive heat and keep soldering temperature between 260°C to 300°C for no more than 5 seconds. Never use wave or reflow soldering.

2. Liquid Crystal Display Modules (MDL)

2.1 Mechanical Considerations

MDL's are assembled and adjusted with a high degree of precision. Avoid excessive shocks and do not make any alterations or modifications. The following should be noted.

- (1) Do not tamper in any way with the tabs on the metal frame.
- (2) Do not modify the PCB by drilling extra holes, changing its outline, moving its components or modifying its pattern.
- (3) Do not touch the elastomer connector (conductive rubber), especially when inserting an EL panel.

- (4) When mounting a MDL make sure that the PCB is not under any stress such as bending or twisting. Elastomer contacts are very delicate and missing pixels could result from slight dislocation of any of the elements.
- (5) Avoid pressing on the metal bezel, otherwise the elastomer connector could be deformed and lose contact, resulting in missing pixels.
- (6) If FPCA need to be bent, please refer the suggested bending area on the specification. The stiffener and component area on FPC/FPC/COF must not be bent during or after assembly (Note: for those models with FPC/FPC/COF +stiffener).
- (7) Sharp bending should be avoided on FPC to prevent track cracking.

2.2 Static Electricity

MDL contains CMOS LSI's and the same precaution for such devices should apply, namely:

- (1) The operator should be grounded whenever he comes into contact with the module. Never touch any of the conductive parts such as the LSI pads, the copper leads on the PCB and the interface terminals with any part of the human body.
- (2) The modules should be kept in antistatic bags or other containers resistant to static for storage.
- (3) Only properly grounded soldering irons should be used.
- (4) If an electric screwdriver is used it should be well grounded and shielded from commutator sparks.
- (5) The normal static prevention measures should be observed for work clothes and working benches; for the latter conductive (rubber) mat is recommended.
- (6) Since dry air is inductive to statics, a relative humidity of 50 - 60% is recommended.

2.3 Soldering

- (1) Solder only to the I/O terminals.
- (2) Use only soldering irons with proper grounding and no leakage.
- (3) Soldering temperature is 280°C ± 10°C .
- (4) Soldering time: 3 to 4 seconds.
- (5) Use eutectic solder with resin flux fill.
- (6) If flux is used, the LCD surface should be covered to avoid flux spatters. Flux residue should be removed afterwards.
- (7) Use proper de-soldering methods (e.g. suction type desoldering irons) to remove lead wires from the I/O terminals when necessary. Do not repeat the soldering/ desoldering process more than three times as the pads and plated through holes may be damaged.

2.4 Label

Identification labels will be stuck on the module without

obstructing the viewing area of display.

3. Operation

- (1) The viewing angle can be adjusted by varying the LCD driving voltage Vo.
- (2) Driving voltage should be kept within specified range, excess voltage shortens display life.
- (3) Response time increases with decrease in temperature.
- (4) Display may turn black or dark Blue at temperatures above its operational range; this is however not destructive and the display will return to normal once the temperature falls back to range.
- (5) Mechanical disturbance during operation (such as pressing on the viewing area) may cause the segments to appear "fractured". They will recover once the display is turned off.
- (6) Condensation at terminals will cause malfunction and possible electrochemical reaction. Relative humidity of the environment should therefore be kept below 60%.
- (7) Display performance may vary out of viewing area. If there is any special requirement on performance out of viewing area, please consult Varitronix.

4. Storage and Reliability

- (1) LCD's should be kept in sealed polyethylene bags while MDL's should use antistatic ones. If properly sealed, there is no need for desiccant.
- (2) Store in dark places and do not expose to sunlight or fluorescent light. Keep the temperature between 0°C and 35°C and the relative humidity low. Please consult VARITRONIX for other storage requirements.
- (3) Water condensation will affect reliability performance of the display and is not allowed.
- (4) Semi-conductor device on the display is sensitive to light and should be protected properly.
- (5) Power up/down sequence.
 - a) Power Up: in general, LCD supply voltage, Vo must be supplied after logic voltage, VDD becomes steady. Please refer to related IC data sheet for details.
 - b) Power Down: in general, LCD supply voltage, VDD must be removed before logic voltage, VDD turns off. Please refer to related IC data sheet for details.

5. Safety

If any fluid leaks out of a damaged glass cell, wash off any human part that comes into contact with soap and water. Never swallow the fluid. The toxicity is extremely low but caution should be exercised at all times.

LIMITED WARRANTY

VARITRONIX LCDs and modules are not consumer products, but may be incorporated by VARITRONIX's customers into consumer products or components thereof. VARITRONIX does not warrant that its LCDs and components are fit for any such particular purpose.

1. The liability of VARITRONIX is limited to repair or replacement on the terms set forth below. VARITRONIX will not be responsible for any subsequent or consequential events or injury or damage to any personnel or user including third party personnel and/or user.

Unless otherwise agreed in writing between VARITRONIX and the customer, VARITRONIX will only replace or repair any of its LCD which is found defective electrically or visually when inspected in

accordance with VARITRONIX LCD Acceptance Standards (copies available on request), for a period of one year from the date of shipment. Confirmation of such date shall be based on freight documents.

2. No warranty can be granted if any of the precautions stated in HANDLING LCD and LCD Modules above have been disregarded. Broken glass, scratches on polarizers, mechanical damages as well as defects that are caused by accelerated environmental tests are excluded from warranty.
3. In returning the LCD and Modules, they must be properly packaged and there should be detailed description of the failures or defects.

IMPORTANT NOTICE

The information presented in this document has been carefully checked and is believed to be accurate, however, no responsibility is assumed for inaccuracies. VARITRONIX reserves the right to make changes to any specifications without further notice for performance, reliability, production technique and other considerations, VARITRONIX does not assume any liability arising out of the application or use of products herein. Please see Limited Warranty in the previous section.

“Varitronix Limited reserves the right to change this specification.”

Tel: (852) 2197-6000.

Fax: (852) 2343-9555.

URL:<http://www.varitronix.com>