

# Metal Oxide Varistor : TVR Series



## Disc Type Varistor for Surge Protection

### ■ Features

1. RoHS compliant
2. Halogen-free series are available
3. Body size:  $\Phi 5 \sim \Phi 20\text{mm}$
4. Wide operating voltage range: 11Vac ~ 1000 Vac
5. Operating temperature range:  $-40^{\circ}\text{C} \sim +105^{\circ}\text{C}$   
Storage temperature range:  $-40^{\circ}\text{C} \sim +125^{\circ}\text{C}$
6. Agency recognition: UL 1449 4<sup>th</sup> / cUL / TUV/ VDE/ CQC



### ■ Recommended Applications

1. Power supply
2. Home appliance
3. Industrial equipment
4. Telecommunication or telephone system
5. Smart meter
6. PLC (Power line communication)
7. Lighting products
8. Photovoltaic industry

### ■ Part Number Code

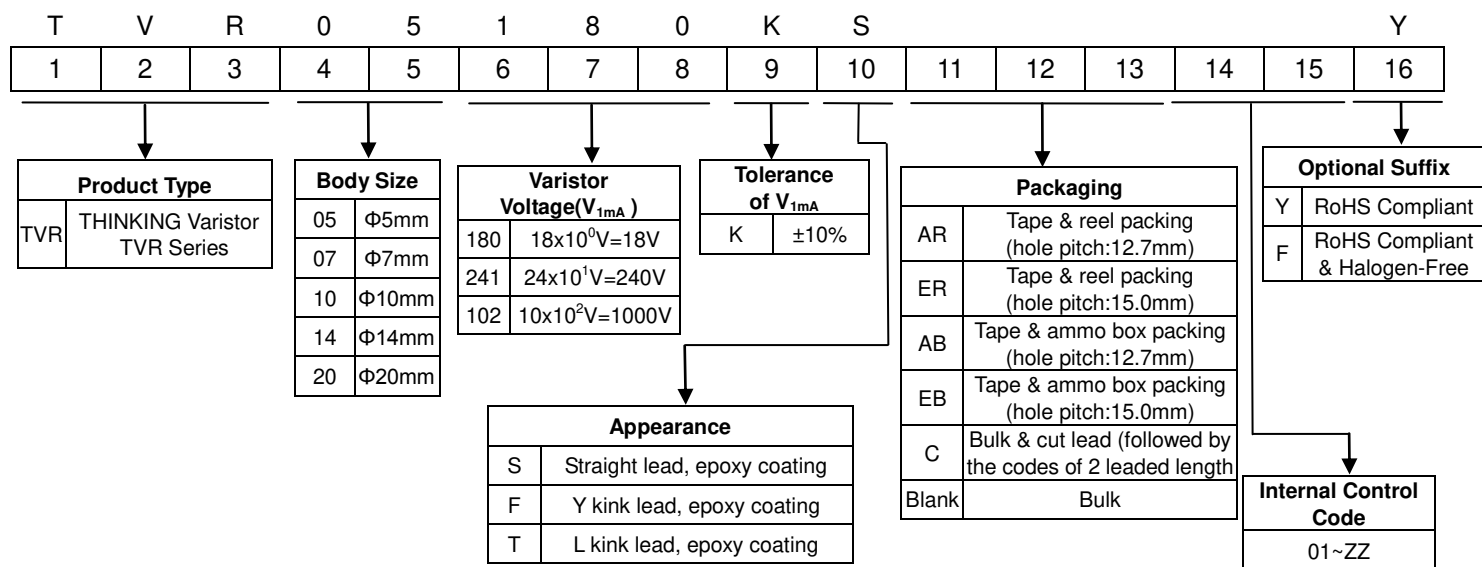

Note: Optional suffix will be the 11<sup>th</sup> digit if packaging and internal control codes are not coded.

# Metal Oxide Varistor : TVR Series



## Disc Type Varistor for Surge Protection

### Structures and Dimensions

#### S Type (Straight lead)

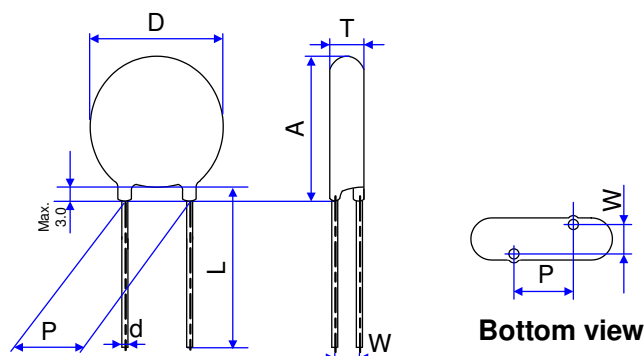

(Unit: mm)

| Series | D                                      | Lmin. | d        | P  | Amax.   | Tmax.  | W |
|--------|--|-------|----------|--|---|--|---|
| TVR05  | 5.0~7.0                                | 26.5  | 0.6±0.02 | 5.0±0.5 (for TVR180-561)<br>5.0±1.0 (for TVR621-751)     | 9.0   | Please refer to the Electrical Characteristics Table |   |
| TVR07  | 6.5~9.0                                | 26.5  | 0.6±0.02 | 5.0±0.5 (for TVR180-561)<br>5.0±1.0 (for TVR621-821)     | 11.0 (for TVR07180~621)<br>11.5 (for TVR07681~821)                            |  |   |
| TVR10  | 9.5~12.5<br>9.5~13.5<br>(for TVR10182) | 26.5  | 0.8±0.02 | 7.5±0.5 (for TVR10180-561)<br>7.5±1.0 (for TVR10621-182) | 15.0 (for TVR10180-112)<br>15.5 (for TVR10122-182)                            |  |   |
| TVR14  | 13.5~16.0                              | 26.5  | 0.8±0.02 | 7.5±0.5 (for TVR14180-561)<br>7.5±1.0 (for TVR14621-182) | 18.5 (for TVR14180-511)<br>19.0 (for TVR14561-182)                            |  |   |
| TVR20  | 19.5~22.0                              | 22.5  | 1.0±0.02 | 10±1   | 25.5 (for TVR20180-511)<br>26.0 (for TVR20561-112)<br>26.5 (for TVR20122-182) |  |   |

# Metal Oxide Varistor : TVR Series



## Disc Type Varistor for Surge Protection

### ■ F Type (Y kink lead)

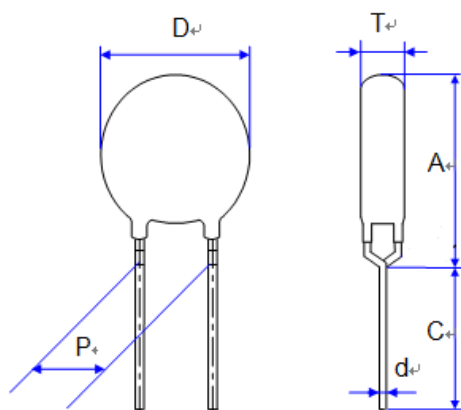

(Unit: mm)

| Series | D                                      | Cmin. | d        | P  | Amax. | Tmax.  |
|--------|--|-------|----------|--|-------|--|
| TVR05  | 5.0~7.0                                | 20    | 0.6±0.02 | 5.0±0.5 (for TVR05180-561)<br>5.0±1.0 (for TVR05621-751) | 9.5   | Please refer to the Electrical Characteristics Table |
| TVR07  | 6.5~9.0                                | 20    | 0.6±0.02 | 5.0±0.5 (for TVR07180-561)<br>5.0±1.0 (for TVR07621-821) | 11.5  |  |
| TVR10  | 9.5~12.5<br>9.5~13.5<br>(for TVR10182) | 20    | 0.8±0.02 | 7.5±0.5 (for TVR10180-561)<br>7.5±1.0 (for TVR10621-182) | 16.0  |  |
| TVR14  | 13.5 ~16.0                             | 20    | 0.8±0.02 | 7.5±0.5 (for TVR14180-561)<br>7.5±1.0 (for TVR14621-182) | 19.0  |  |
| TVR20  | 19.5~22                                | 20    | 1.0±0.02 | 10±1   | 26.5  |  |

### ■ T Type (L kink lead)

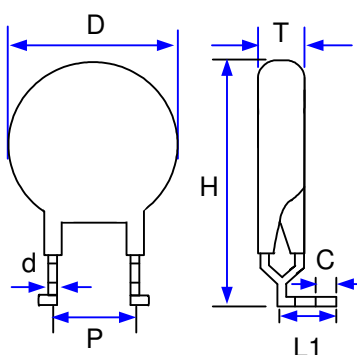

(Unit: mm)

| Series | D                                      | C       | d        | P     | Hmax. | L1     | Tmax.  |
|--------|--|---------|----------|-------|-------|--------|--|
| TVR10  | 9.5~12.5<br>9.5~13.5<br>(for TVR10182) | 3.8±0.8 | 0.8±0.02 | 7.5±1 | 20.0  | 7.0±1  | Please refer to the Electrical Characteristics Table |
| TVR14  | 13.5 ~16.0                             |         | 0.8±0.02 | 7.5±1 | 23.5  | 10.0±1 |  |
| TVR20  | 19.5~22                                |         | 1.0±0.02 | 10±1  | 30.5  | 9.0±1  |  |

# Metal Oxide Varistor : TVR Series



## Disc Type Varistor for Surge Protection

### ■ Electrical Characteristics 05mm Series

| Part No. | Varistor Voltage<br>(@ 1mA DC) | Max. Continuous Voltage |          | Max. Clamping Voltage<br>(8/20 $\mu$ s) |       | Max. Surge Current<br>(8/20 $\mu$ s) | Rated Power | Max. Energy<br>(10/1000 $\mu$ s) | Dimension |           |                |
|----------|--------------------------------|-------------------------|----------|---|-------|--------------------------------------|-------------|----------------------------------|-----------|-----------|----------------|
|          | $V_{1mA}$                      | $V_{AC(rms)}$           | $V_{DC}$ | $V_P$                                   | $I_P$ | $I_{max}$                            | P           | $W_{max}$                        | $T_{min}$ | $T_{max}$ | W<br>$\pm 1.0$ |
|          | (V)                            | (V)                     | (V)      | (V)                                     | (A)   | (A)                                  | (W)         | (J)                              | (mm)      |           |                |
| TVR05180 | 18 (16~20)                     | 11                      | 14       | 40                                      | 1.0   | 100                                  | 0.01        | 0.4                              | 2.2       | 3.9       | 1.5            |
| TVR05220 | 22 (20~24)                     | 14                      | 18       | 48                                      | 1.0   | 100                                  | 0.01        | 0.5                              | 2.2       | 4.1       | 1.5            |
| TVR05270 | 27 (24~30)                     | 17                      | 22       | 60                                      | 1.0   | 100                                  | 0.01        | 0.6                              | 2.4       | 4.3       | 1.5            |
| TVR05330 | 33 (30~36)                     | 20                      | 26       | 73                                      | 1.0   | 100                                  | 0.01        | 0.8                              | 2.6       | 4.5       | 1.5            |
| TVR05390 | 39 (35~43)                     | 25                      | 31       | 86                                      | 1.0   | 100                                  | 0.01        | 0.9                              | 2.6       | 4.6       | 1.5            |
| TVR05470 | 47 (42~52)                     | 30                      | 38       | 104                                     | 1.0   | 100                                  | 0.01        | 1.1                              | 2.3       | 4.2       | 1.5            |
| TVR05560 | 56 (50~62)                     | 35                      | 45       | 123                                     | 1.0   | 100                                  | 0.01        | 1.3                              | 2.6       | 4.3       | 1.5            |
| TVR05680 | 68 (61~75)                     | 40                      | 56       | 150                                     | 1.0   | 100                                  | 0.01        | 1.6                              | 2.8       | 4.6       | 1.5            |
| TVR05820 | 82 (74~90)                     | 50                      | 65       | 145                                     | 5.0   | 400                                  | 0.1         | 2.5                              | 2.0       | 3.9       | 1.5            |
| TVR05101 | 100 (90~110)                   | 60                      | 85       | 175                                     | 5.0   | 400                                  | 0.1         | 3.0                              | 2.1       | 4.1       | 1.6            |
| TVR05121 | 120 (108~132)                  | 75                      | 100      | 210                                     | 5.0   | 400                                  | 0.1         | 4.0                              | 2.5       | 4.3       | 1.8            |
| TVR05151 | 150 (135~165)                  | 95                      | 125      | 260                                     | 5.0   | 400                                  | 0.1         | 4.8                              | 2.0       | 4.6       | 1.6            |
| TVR05181 | 180 (162~198)                  | 115                     | 150      | 315                                     | 5.0   | 400                                  | 0.1         | 5.9                              | 2.0       | 3.9       | 1.4            |
| TVR05201 | 200 (180~220)                  | 130                     | 170      | 355                                     | 5.0   | 400                                  | 0.1         | 6.5                              | 2.1       | 4.0       | 1.5            |
| TVR05221 | 220 (198~242)                  | 140                     | 180      | 380                                     | 5.0   | 400                                  | 0.1         | 7.0                              | 2.1       | 4.0       | 1.5            |
| TVR05241 | 240 (216~264)                  | 150                     | 200      | 415                                     | 5.0   | 400                                  | 0.1         | 8.0                              | 2.3       | 4.2       | 1.6            |
| TVR05271 | 270 (243~297)                  | 175                     | 225      | 475                                     | 5.0   | 400                                  | 0.1         | 8.5                              | 2.4       | 4.4       | 1.7            |
| TVR05301 | 300 (270~330)                  | 195                     | 250      | 525                                     | 5.0   | 400                                  | 0.1         | 8.5                              | 2.7       | 4.4       | 1.9            |
| TVR05331 | 330 (297~363)                  | 215                     | 275      | 585                                     | 5.0   | 400                                  | 0.1         | 9.2                              | 2.8       | 4.5       | 2.0            |
| TVR05361 | 360 (324~396)                  | 230                     | 300      | 620                                     | 5.0   | 400                                  | 0.1         | 10                               | 2.9       | 4.6       | 2.1            |
| TVR05391 | 390 (351~429)                  | 250                     | 320      | 675                                     | 5.0   | 400                                  | 0.1         | 12                               | 3.1       | 4.8       | 2.3            |
| TVR05431 | 430 (387~473)                  | 275                     | 350      | 745                                     | 5.0   | 400                                  | 0.1         | 13                               | 3.0       | 5.1       | 2.3            |
| TVR05471 | 470 (423~517)                  | 300                     | 385      | 810                                     | 5.0   | 400                                  | 0.1         | 15                               | 3.2       | 5.2       | 2.4            |
| TVR05511 | 510 (459~561)                  | 320                     | 410      | 878                                     | 5.0   | 400                                  | 0.1         | 16                               | 3.4       | 5.4       | 2.6            |
| TVR05561 | 560 (504~616)                  | 350                     | 450      | 962                                     | 5.0   | 400                                  | 0.1         | 18                               | 3.6       | 5.5       | 2.8            |
| TVR05621 | 620 (558~682)                  | 395                     | 510      | 1050                                    | 5.0   | 400                                  | 0.1         | 18                               | 3.9       | 5.9       | 3.0            |
| TVR05681 | 680 (612~748)                  | 420                     | 560      | 1120                                    | 5.0   | 400                                  | 0.1         | 18                               | 4.1       | 6.2       | 3.2            |
| TVR05751 | 750 (675~825)                  | 465                     | 615      | 1240                                    | 5.0   | 400                                  | 0.1         | 18                               | 4.4       | 6.4       | 3.5            |

# Metal Oxide Varistor : TVR Series



## Disc Type Varistor for Surge Protection

### 07mm Series

| Part No. | Varistor Voltage<br>(@ 1mA DC) | Max. Continuous Voltage |                 | Max. Clamping Voltage<br>(8/20μs) |                | Max. Surge Current<br>(8/20μs) | Rated Power | Max. Energy<br>(10/1000μs) | Dimension        |                  |           |
|----------|--------------------------------|-------------------------|-----------------|-----------------------------------|----------------|--------------------------------|-------------|----------------------------|------------------|------------------|-----------|
|          | V <sub>1mA</sub>               | V <sub>AC(rms)</sub>    | V <sub>DC</sub> | V <sub>P</sub>                    | I <sub>P</sub> | I <sub>max</sub>               | P           | W <sub>max</sub>           | T <sub>min</sub> | T <sub>max</sub> | W<br>±1.0 |
|          | (V)                            | (V)                     | (V)             | (V)                               | (A)            | (A)                            | (W)         | (J)                        | (mm)             |                  |           |
| TVR07180 | 18 (16~20)                     | 11                      | 14              | 36                                | 2.5            | 250                            | 0.02        | 0.9                        | 2.2              | 3.9              | 1.3       |
| TVR07220 | 22 (20~24)                     | 14                      | 18              | 43                                | 2.5            | 250                            | 0.02        | 1.1                        | 2.2              | 4.1              | 1.4       |
| TVR07270 | 27 (24~30)                     | 17                      | 22              | 53                                | 2.5            | 250                            | 0.02        | 1.4                        | 2.4              | 4.3              | 1.5       |
| TVR07330 | 33 (30~36)                     | 20                      | 26              | 65                                | 2.5            | 250                            | 0.02        | 1.7                        | 2.6              | 4.5              | 1.7       |
| TVR07390 | 39 (35~43)                     | 25                      | 31              | 77                                | 2.5            | 250                            | 0.02        | 2.1                        | 2.6              | 4.6              | 1.8       |
| TVR07470 | 47 (42~52)                     | 30                      | 38              | 93                                | 2.5            | 250                            | 0.02        | 2.5                        | 2.3              | 4.2              | 1.9       |
| TVR07560 | 56 (50~62)                     | 35                      | 45              | 110                               | 2.5            | 250                            | 0.02        | 3.1                        | 2.6              | 4.3              | 2.0       |
| TVR07680 | 68 (61~75)                     | 40                      | 56              | 135                               | 2.5            | 250                            | 0.02        | 3.6                        | 2.3              | 4.6              | 2.1       |
| TVR07820 | 82 (74~90)                     | 50                      | 65              | 135                               | 10             | 1200                           | 0.25        | 5.5                        | 2.0              | 3.9              | 1.5       |
| TVR07101 | 100 (90~110)                   | 60                      | 85              | 165                               | 10             | 1200                           | 0.25        | 6.5                        | 2.1              | 4.1              | 1.6       |
| TVR07121 | 120 (108~132)                  | 75                      | 100             | 200                               | 10             | 1200                           | 0.25        | 7.8                        | 2.5              | 4.3              | 1.8       |
| TVR07151 | 150 (135~165)                  | 95                      | 125             | 250                               | 10             | 1200                           | 0.25        | 9.7                        | 2.0              | 4.6              | 1.6       |
| TVR07181 | 180 (162~198)                  | 115                     | 150             | 300                               | 10             | 1200                           | 0.25        | 11.7                       | 2.0              | 3.9              | 1.4       |
| TVR07201 | 200 (180~220)                  | 130                     | 170             | 340                               | 10             | 1200                           | 0.25        | 13                         | 2.1              | 4.0              | 1.5       |
| TVR07221 | 220 (198~242)                  | 140                     | 180             | 360                               | 10             | 1200                           | 0.25        | 14                         | 2.1              | 4.0              | 1.5       |
| TVR07241 | 240 (216~264)                  | 150                     | 200             | 395                               | 10             | 1200                           | 0.25        | 15                         | 2.3              | 4.2              | 1.6       |
| TVR07271 | 270 (243~297)                  | 175                     | 225             | 455                               | 10             | 1200                           | 0.25        | 18                         | 2.4              | 4.4              | 1.7       |
| TVR07301 | 300 (270~330)                  | 195                     | 250             | 500                               | 10             | 1200                           | 0.25        | 21                         | 2.7              | 4.4              | 1.9       |
| TVR07331 | 330 (297~363)                  | 215                     | 275             | 550                               | 10             | 1200                           | 0.25        | 23                         | 2.8              | 4.5              | 2.0       |
| TVR07361 | 360 (324~396)                  | 230                     | 300             | 595                               | 10             | 1200                           | 0.25        | 25                         | 2.9              | 4.6              | 2.1       |
| TVR07391 | 390 (351~429)                  | 250                     | 320             | 650                               | 10             | 1200                           | 0.25        | 25                         | 3.1              | 4.8              | 2.3       |
| TVR07431 | 430 (387~473)                  | 275                     | 350             | 710                               | 10             | 1200                           | 0.25        | 28                         | 3.0              | 5.1              | 2.3       |
| TVR07471 | 470 (423~517)                  | 300                     | 385             | 775                               | 10             | 1200                           | 0.25        | 30                         | 3.2              | 5.2              | 2.4       |
| TVR07511 | 510 (459~561)                  | 320                     | 410             | 845                               | 10             | 1200                           | 0.25        | 33                         | 3.4              | 5.4              | 2.6       |
| TVR07561 | 560 (504~616)                  | 350                     | 450             | 930                               | 10             | 1200                           | 0.25        | 33                         | 3.6              | 5.5              | 2.8       |
| TVR07621 | 620 (558~682)                  | 395                     | 510             | 1020                              | 10             | 1200                           | 0.25        | 35                         | 3.9              | 5.9              | 3.0       |
| TVR07681 | 680 (612~748)                  | 420                     | 560             | 1120                              | 10             | 1200                           | 0.25        | 35                         | 4.1              | 6.2              | 3.2       |
| TVR07751 | 750 (675~825)                  | 465                     | 615             | 1235                              | 10             | 1200                           | 0.25        | 38                         | 4.4              | 6.4              | 3.5       |
| TVR07821 | 820 (738~902)                  | 510                     | 670             | 1355                              | 10             | 1200                           | 0.25        | 42                         | 4.5              | 6.4              | 3.2       |

# Metal Oxide Varistor : TVR Series



## Disc Type Varistor for Surge Protection

### 10mm Series

| Part No. | Varistor Voltage<br>(@ 1mA DC) | Max. Continuous Voltage |          | Max. Clamping Voltage<br>(8/20 $\mu$ s) |       | Max. Surge Current<br>(8/20 $\mu$ s) | Rated Power | Max. Energy<br>(10/1000 $\mu$ s) | Dimension |           |               |
|----------|--------------------------------|-------------------------|----------|---|-------|--------------------------------------|-------------|----------------------------------|-----------|-----------|---------------|
|          | $V_{1mA}$                      | $V_{AC(rms)}$           | $V_{DC}$ | $V_P$                                   | $I_P$ | $I_{max}$                            | P           | $W_{max}$                        | $T_{min}$ | $T_{max}$ | $W_{\pm 1.0}$ |
|          | (V)                            | (V)                     | (V)      | (V)                                     | (A)   | (A)                                  | (W)         | (J)                              | (mm)      |           |               |
| TVR10180 | 18 (16~20)                     | 11                      | 14       | 36                                      | 5.0   | 500                                  | 0.05        | 2.1                              | 2.6       | 4.3       | 1.3           |
| TVR10220 | 22 (20~24)                     | 14                      | 18       | 43                                      | 5.0   | 500                                  | 0.05        | 2.5                              | 2.6       | 4.5       | 1.4           |
| TVR10270 | 27 (24~30)                     | 17                      | 22       | 53                                      | 5.0   | 500                                  | 0.05        | 3.0                              | 2.8       | 4.7       | 1.5           |
| TVR10330 | 33 (30~36)                     | 20                      | 26       | 65                                      | 5.0   | 500                                  | 0.05        | 4.0                              | 2.9       | 4.9       | 1.7           |
| TVR10390 | 39 (35~43)                     | 25                      | 31       | 77                                      | 5.0   | 500                                  | 0.05        | 4.6                              | 2.7       | 5.1       | 1.8           |
| TVR10470 | 47 (42~52)                     | 30                      | 38       | 93                                      | 5.0   | 500                                  | 0.05        | 5.5                              | 2.7       | 4.5       | 1.8           |
| TVR10560 | 56 (50~62)                     | 35                      | 45       | 110                                     | 5.0   | 500                                  | 0.05        | 7.0                              | 3.0       | 4.7       | 1.9           |
| TVR10680 | 68 (61~75)                     | 40                      | 56       | 135                                     | 5.0   | 500                                  | 0.05        | 8.2                              | 2.6       | 5.0       | 2.2           |
| TVR10820 | 82 (74~90)                     | 50                      | 65       | 135                                     | 25    | 2500                                 | 0.4         | 12                               | 2.4       | 4.3       | 1.6           |
| TVR10101 | 100 (90~110)                   | 60                      | 85       | 165                                     | 25    | 2500                                 | 0.4         | 15                               | 2.6       | 4.5       | 1.8           |
| TVR10121 | 120 (108~132)                  | 75                      | 100      | 200                                     | 25    | 2500                                 | 0.4         | 18                               | 2.9       | 4.7       | 2.0           |
| TVR10151 | 150 (135~165)                  | 95                      | 125      | 250                                     | 25    | 2500                                 | 0.4         | 22                               | 2.4       | 5.0       | 1.8           |
| TVR10181 | 180 (162~198)                  | 115                     | 150      | 300                                     | 25    | 2500                                 | 0.4         | 27                               | 2.4       | 4.3       | 1.6           |
| TVR10201 | 200 (180~220)                  | 130                     | 170      | 340                                     | 25    | 2500                                 | 0.4         | 30                               | 2.5       | 4.4       | 1.7           |
| TVR10221 | 220 (198~242)                  | 140                     | 180      | 360                                     | 25    | 2500                                 | 0.4         | 32                               | 2.5       | 4.4       | 1.7           |
| TVR10241 | 240 (216~264)                  | 150                     | 200      | 395                                     | 25    | 2500                                 | 0.4         | 35                               | 2.7       | 4.6       | 1.8           |
| TVR10271 | 270 (243~297)                  | 175                     | 225      | 455                                     | 25    | 2500                                 | 0.4         | 40                               | 2.8       | 4.8       | 1.9           |
| TVR10301 | 300 (270~330)                  | 195                     | 250      | 500                                     | 25    | 2500                                 | 0.4         | 40                               | 3.1       | 4.8       | 2.1           |
| TVR10331 | 330 (297~363)                  | 215                     | 275      | 550                                     | 25    | 2500                                 | 0.4         | 43                               | 3.2       | 4.9       | 2.2           |
| TVR10361 | 360 (324~396)                  | 230                     | 300      | 595                                     | 25    | 2500                                 | 0.4         | 47                               | 3.3       | 5.0       | 2.3           |
| TVR10391 | 390 (351~429)                  | 250                     | 320      | 650                                     | 25    | 2500                                 | 0.4         | 60                               | 3.5       | 5.2       | 2.5           |
| TVR10431 | 430 (387~473)                  | 275                     | 350      | 710                                     | 25    | 2500                                 | 0.4         | 65                               | 3.4       | 5.5       | 2.5           |
| TVR10471 | 470 (423~517)                  | 300                     | 385      | 775                                     | 25    | 2500                                 | 0.4         | 70                               | 3.6       | 5.6       | 2.6           |
| TVR10511 | 510 (459~561)                  | 320                     | 410      | 845                                     | 25    | 2500                                 | 0.4         | 70                               | 3.8       | 5.8       | 2.8           |
| TVR10561 | 560 (504~616)                  | 350                     | 450      | 930                                     | 25    | 2500                                 | 0.4         | 70                               | 4.0       | 5.9       | 3.0           |
| TVR10621 | 620 (558~682)                  | 395                     | 510      | 1020                                    | 25    | 2500                                 | 0.4         | 70                               | 4.3       | 6.3       | 3.2           |
| TVR10681 | 680 (612~748)                  | 420                     | 560      | 1120                                    | 25    | 2500                                 | 0.4         | 70                               | 4.5       | 6.6       | 3.4           |
| TVR10751 | 750 (675~825)                  | 465                     | 615      | 1235                                    | 25    | 2500                                 | 0.4         | 75                               | 4.8       | 6.8       | 3.7           |
| TVR10821 | 820 (738~902)                  | 510                     | 670      | 1355                                    | 25    | 2500                                 | 0.4         | 85                               | 4.9       | 6.8       | 3.4           |
| TVR10911 | 910 (819~1001)                 | 550                     | 745      | 1500                                    | 25    | 2500                                 | 0.4         | 93                               | 5.3       | 7.2       | 3.7           |
| TVR10102 | 1000 (900~1100)                | 625                     | 825      | 1650                                    | 25    | 2500                                 | 0.4         | 102                              | 5.5       | 7.5       | 4.0           |
| TVR10112 | 1100 (990~1210)                | 680                     | 895      | 1815                                    | 25    | 2500                                 | 0.4         | 115                              | 5.7       | 8.0       | 4.3           |
| TVR10122 | 1200 (1080~1320)               | 725                     | 975      | 1980                                    | 25    | 2500                                 | 0.4         | 125                              | 6.0       | 8.1       | 5.2           |
| TVR10142 | 1400 (1260~1540)               | 820                     | 1140     | 2300                                    | 25    | 2500                                 | 0.4         | 145                              | 6.6       | 8.7       | 6.0           |
| TVR10162 | 1600 (1440~1760)               | 910                     | 1300     | 2630                                    | 25    | 2500                                 | 0.4         | 165                              | 7.1       | 9.8       | 6.7           |
| TVR10182 | 1800 (1620~1980)               | 1000                    | 1465     | 2950                                    | 25    | 2500                                 | 0.4         | 185                              | 7.8       | 10.3      | 7.4           |

# Metal Oxide Varistor : TVR Series



## Disc Type Varistor for Surge Protection

### 14mm Series

| Part No. | Varistor Voltage<br>(@ 1mA DC) | Max. Continuous Voltage |                 | Max. Clamping Voltage<br>(8/20 $\mu$ s) |                | Max. Surge Current<br>(8/20 $\mu$ s) | Rated Power | Max. Energy<br>(10/1000 $\mu$ s) | Dimension        |                  |                |
|----------|--------------------------------|-------------------------|-----------------|---|----------------|--------------------------------------|-------------|----------------------------------|------------------|------------------|----------------|
|          | V <sub>1mA</sub>               | V <sub>AC(rms)</sub>    | V <sub>DC</sub> | V <sub>P</sub>                          | I <sub>P</sub> | I <sub>max</sub>                     | P           | W <sub>max</sub>                 | T <sub>min</sub> | T <sub>max</sub> | W<br>$\pm$ 1.0 |
|          | (V)                            | (V)                     | (V)             | (V)                                     | (A)            | (A)                                  | (W)         | (J)                              | (mm)             |                  |                |
| TVR14180 | 18 (16~20)                     | 11                      | 14              | 36                                      | 10             | 1000                                 | 0.1         | 4.0                              | 2.6              | 4.3              | 1.3            |
| TVR14220 | 22 (20~24)                     | 14                      | 18              | 43                                      | 10             | 1000                                 | 0.1         | 5.0                              | 2.6              | 4.5              | 1.4            |
| TVR14270 | 27 (24~30)                     | 17                      | 22              | 53                                      | 10             | 1000                                 | 0.1         | 6.0                              | 2.8              | 4.7              | 1.5            |
| TVR14330 | 33 (30~36)                     | 20                      | 26              | 65                                      | 10             | 1000                                 | 0.1         | 7.5                              | 2.9              | 4.9              | 1.7            |
| TVR14390 | 39 (35~43)                     | 25                      | 31              | 77                                      | 10             | 1000                                 | 0.1         | 8.6                              | 2.7              | 5.1              | 1.8            |
| TVR14470 | 47 (42~52)                     | 30                      | 38              | 93                                      | 10             | 1000                                 | 0.1         | 10                               | 2.7              | 4.5              | 1.8            |
| TVR14560 | 56 (50~62)                     | 35                      | 45              | 110                                     | 10             | 1000                                 | 0.1         | 11                               | 3.0              | 4.7              | 1.9            |
| TVR14680 | 68 (61~75)                     | 40                      | 56              | 135                                     | 10             | 1000                                 | 0.1         | 14                               | 3.1              | 5.0              | 2.2            |
| TVR14820 | 82 (74~90)                     | 50                      | 65              | 135                                     | 50             | 4500                                 | 0.6         | 22                               | 2.4              | 4.3              | 1.6            |
| TVR14101 | 100 (90~110)                   | 60                      | 85              | 165                                     | 50             | 4500                                 | 0.6         | 28                               | 2.6              | 4.5              | 1.8            |
| TVR14121 | 120 (108~132)                  | 75                      | 100             | 200                                     | 50             | 4500                                 | 0.6         | 32                               | 2.9              | 4.7              | 2.0            |
| TVR14151 | 150 (135~165)                  | 95                      | 125             | 250                                     | 50             | 4500                                 | 0.6         | 40                               | 2.4              | 5.0              | 1.8            |
| TVR14181 | 180 (162~198)                  | 115                     | 150             | 300                                     | 50             | 4500                                 | 0.6         | 52                               | 2.4              | 4.3              | 1.6            |
| TVR14201 | 200 (180~220)                  | 130                     | 170             | 340                                     | 50             | 4500                                 | 0.6         | 57                               | 2.5              | 4.4              | 1.7            |
| TVR14221 | 220 (198~242)                  | 140                     | 180             | 360                                     | 50             | 4500                                 | 0.6         | 60                               | 2.5              | 4.4              | 1.7            |
| TVR14241 | 240 (216~264)                  | 150                     | 200             | 395                                     | 50             | 4500                                 | 0.6         | 63                               | 2.7              | 4.6              | 1.8            |
| TVR14271 | 270 (243~297)                  | 175                     | 225             | 455                                     | 50             | 4500                                 | 0.6         | 70                               | 2.8              | 4.8              | 1.9            |
| TVR14301 | 300 (270~330)                  | 195                     | 250             | 500                                     | 50             | 4500                                 | 0.6         | 78                               | 3.1              | 4.8              | 2.1            |
| TVR14331 | 330 (297~363)                  | 215                     | 275             | 550                                     | 50             | 4500                                 | 0.6         | 85                               | 3.2              | 4.9              | 2.2            |
| TVR14361 | 360 (324~396)                  | 230                     | 300             | 595                                     | 50             | 4500                                 | 0.6         | 93                               | 3.3              | 5.0              | 2.3            |
| TVR14391 | 390 (351~429)                  | 250                     | 320             | 650                                     | 50             | 4500                                 | 0.6         | 100                              | 3.5              | 5.2              | 2.5            |
| TVR14431 | 430 (387~473)                  | 275                     | 350             | 710                                     | 50             | 4500                                 | 0.6         | 115                              | 3.4              | 5.5              | 2.5            |
| TVR14471 | 470 (423~517)                  | 300                     | 385             | 775                                     | 50             | 4500                                 | 0.6         | 125                              | 3.6              | 5.6              | 2.6            |
| TVR14511 | 510 (459~561)                  | 320                     | 410             | 845                                     | 50             | 4500                                 | 0.6         | 125                              | 3.8              | 5.8              | 2.8            |
| TVR14561 | 560 (504~616)                  | 350                     | 450             | 930                                     | 50             | 4500                                 | 0.6         | 125                              | 4.0              | 5.9              | 3.0            |
| TVR14621 | 620 (558~682)                  | 395                     | 510             | 1020                                    | 50             | 4500                                 | 0.6         | 125                              | 4.3              | 6.3              | 3.2            |
| TVR14681 | 680 (612~748)                  | 420                     | 560             | 1120                                    | 50             | 4500                                 | 0.6         | 130                              | 4.5              | 6.6              | 3.4            |
| TVR14751 | 750 (675~825)                  | 465                     | 615             | 1235                                    | 50             | 4500                                 | 0.6         | 143                              | 4.8              | 6.8              | 3.7            |
| TVR14821 | 820 (738~902)                  | 510                     | 670             | 1355                                    | 50             | 4500                                 | 0.6         | 157                              | 4.9              | 6.8              | 3.4            |
| TVR14911 | 910 (819~1001)                 | 550                     | 745             | 1500                                    | 50             | 4500                                 | 0.6         | 175                              | 5.3              | 7.2              | 3.7            |
| TVR14102 | 1000 (900~1100)                | 625                     | 825             | 1650                                    | 50             | 4500                                 | 0.6         | 190                              | 5.5              | 7.5              | 4.0            |
| TVR14112 | 1100 (990~1210)                | 680                     | 895             | 1815                                    | 50             | 4500                                 | 0.6         | 213                              | 5.6              | 8.0              | 4.3            |
| TVR14122 | 1200 (1080~1320)               | 725                     | 975             | 1980                                    | 50             | 4500                                 | 0.6         | 230                              | 6.0              | 8.1              | 5.2            |
| TVR14142 | 1400 (1260~1540)               | 820                     | 1140            | 2300                                    | 50             | 4500                                 | 0.6         | 250                              | 6.6              | 8.7              | 6.0            |
| TVR14162 | 1600 (1440~1760)               | 910                     | 1300            | 2630                                    | 50             | 4500                                 | 0.6         | 315                              | 7.1              | 9.8              | 6.7            |
| TVR14182 | 1800 (1620~1980)               | 1000                    | 1465            | 2950                                    | 50             | 4500                                 | 0.6         | 354                              | 7.8              | 10.3             | 7.4            |

# Metal Oxide Varistor : TVR Series



## Disc Type Varistor for Surge Protection

### 20mm Series

| Part No. | Varistor Voltage (@ 1mA DC) | Max. Continuous Voltage |                 | Max. Clamping Voltage (8/20 $\mu$ s) |                | Max. Surge Current (8/20 $\mu$ s) | Rated Power | Max. Energy (10/1000 $\mu$ s) | Dimension        |                  |                   |
|----------|-----------------------------|-------------------------|-----------------|--------------------------------------|----------------|-----------------------------------|-------------|-------------------------------|------------------|------------------|-------------------|
|          | V <sub>1mA</sub>            | V <sub>AC(rms)</sub>    | V <sub>DC</sub> | V <sub>P</sub>                       | I <sub>P</sub> | I <sub>max</sub>                  | P           | W <sub>max</sub>              | T <sub>min</sub> | T <sub>max</sub> | W <sub>±1.0</sub> |
|          | (V)                         | (V)                     | (V)             | (V)                                  | (A)            | (A)                               | (W)         | (J)                           | (mm)             |                  |                   |
| TVR20180 | 18 (16~20)                  | 11                      | 14              | 36                                   | 20             | 2000                              | 0.2         | 11                            | 3.0              | 4.7              | 1.3               |
| TVR20220 | 22 (20~24)                  | 14                      | 18              | 43                                   | 20             | 2000                              | 0.2         | 14                            | 3.0              | 4.9              | 1.4               |
| TVR20270 | 27 (24~30)                  | 17                      | 22              | 53                                   | 20             | 2000                              | 0.2         | 18                            | 3.2              | 5.1              | 1.5               |
| TVR20330 | 33 (30~36)                  | 20                      | 26              | 65                                   | 20             | 2000                              | 0.2         | 23                            | 3.4              | 5.3              | 1.7               |
| TVR20390 | 39 (35~43)                  | 25                      | 31              | 77                                   | 20             | 2000                              | 0.2         | 26                            | 3.1              | 5.5              | 1.7               |
| TVR20470 | 47 (42~52)                  | 30                      | 38              | 93                                   | 20             | 2000                              | 0.2         | 33                            | 3.1              | 4.9              | 1.8               |
| TVR20560 | 56 (50~62)                  | 35                      | 45              | 110                                  | 20             | 2000                              | 0.2         | 41                            | 3.4              | 5.1              | 2.0               |
| TVR20680 | 68 (61~75)                  | 40                      | 56              | 135                                  | 20             | 2000                              | 0.2         | 46                            | 3.5              | 5.4              | 2.2               |
| TVR20820 | 82 (74~90)                  | 50                      | 65              | 135                                  | 100            | 6500                              | 1.0         | 48                            | 2.8              | 4.7              | 1.8               |
| TVR20101 | 100 (90~110)                | 60                      | 85              | 165                                  | 100            | 6500                              | 1.0         | 51                            | 3.1              | 4.9              | 2.0               |
| TVR20121 | 120 (108~132)               | 75                      | 100             | 200                                  | 100            | 6500                              | 1.0         | 55                            | 3.3              | 5.1              | 2.2               |
| TVR20151 | 150 (135~165)               | 95                      | 125             | 250                                  | 100            | 6500                              | 1.0         | 70                            | 2.8              | 5.4              | 2.0               |
| TVR20181 | 180 (162~198)               | 115                     | 150             | 300                                  | 100            | 6500                              | 1.0         | 84                            | 2.8              | 4.7              | 1.8               |
| TVR20201 | 200 (180~220)               | 130                     | 170             | 340                                  | 100            | 6500                              | 1.0         | 95                            | 2.9              | 4.8              | 1.9               |
| TVR20221 | 220 (198~242)               | 140                     | 180             | 360                                  | 100            | 6500                              | 1.0         | 100                           | 2.9              | 4.8              | 1.9               |
| TVR20241 | 240 (216~264)               | 150                     | 200             | 395                                  | 100            | 6500                              | 1.0         | 108                           | 3.1              | 5.0              | 2.0               |
| TVR20271 | 270 (243~297)               | 175                     | 225             | 455                                  | 100            | 6500                              | 1.0         | 127                           | 3.2              | 5.2              | 2.1               |
| TVR20301 | 300 (270~330)               | 195                     | 250             | 500                                  | 100            | 6500                              | 1.0         | 136                           | 3.5              | 5.2              | 2.3               |
| TVR20331 | 330 (297~363)               | 215                     | 275             | 550                                  | 100            | 6500                              | 1.0         | 150                           | 3.6              | 5.3              | 2.4               |
| TVR20361 | 360 (324~396)               | 230                     | 300             | 595                                  | 100            | 6500                              | 1.0         | 163                           | 3.7              | 5.4              | 2.5               |
| TVR20391 | 390 (351~429)               | 250                     | 320             | 650                                  | 100            | 6500                              | 1.0         | 180                           | 3.9              | 5.6              | 2.7               |
| TVR20431 | 430 (387~473)               | 275                     | 350             | 710                                  | 100            | 6500                              | 1.0         | 190                           | 3.8              | 5.9              | 2.7               |
| TVR20471 | 470 (423~517)               | 300                     | 385             | 775                                  | 100            | 6500                              | 1.0         | 220                           | 4.0              | 6.0              | 2.8               |
| TVR20511 | 510 (459~561)               | 320                     | 410             | 845                                  | 100            | 6500                              | 1.0         | 220                           | 4.2              | 6.2              | 3.0               |
| TVR20561 | 560 (504~616)               | 350                     | 450             | 930                                  | 100            | 6500                              | 1.0         | 220                           | 4.4              | 6.3              | 3.2               |
| TVR20621 | 620 (558~682)               | 395                     | 510             | 1020                                 | 100            | 6500                              | 1.0         | 220                           | 4.7              | 6.7              | 3.4               |
| TVR20681 | 680 (612~748)               | 420                     | 560             | 1120                                 | 100            | 6500                              | 1.0         | 230                           | 4.9              | 7.0              | 3.6               |
| TVR20751 | 750 (675~825)               | 465                     | 615             | 1235                                 | 100            | 6500                              | 1.0         | 255                           | 5.2              | 7.2              | 3.9               |
| TVR20821 | 820 (738~902)               | 510                     | 670             | 1355                                 | 100            | 6500                              | 1.0         | 282                           | 5.3              | 7.2              | 3.6               |
| TVR20911 | 910 (819~1001)              | 550                     | 745             | 1500                                 | 100            | 6500                              | 1.0         | 310                           | 5.7              | 7.6              | 3.9               |
| TVR20102 | 1000 (900~1100)             | 625                     | 825             | 1650                                 | 100            | 6500                              | 1.0         | 342                           | 6.1              | 7.9              | 4.2               |
| TVR20112 | 1100 (990~1210)             | 680                     | 895             | 1815                                 | 100            | 6500                              | 1.0         | 383                           | 6.2              | 8.4              | 4.5               |
| TVR20122 | 1200 (1080~1320)            | 725                     | 975             | 1980                                 | 100            | 6500                              | 1.0         | 415                           | 6.4              | 8.5              | 5.4               |
| TVR20142 | 1400 (1260~1540)            | 820                     | 1140            | 2300                                 | 100            | 6500                              | 1.0         | 480                           | 7.0              | 9.1              | 6.2               |
| TVR20162 | 1600 (1440~1760)            | 910                     | 1300            | 2630                                 | 100            | 6500                              | 1.0         | 550                           | 7.5              | 10.2             | 6.9               |
| TVR20182 | 1800 (1620~1980)            | 1000                    | 1465            | 2950                                 | 100            | 6500                              | 1.0         | 620                           | 8.5              | 10.7             | 7.6               |







# Metal Oxide Varistor : TVR Series

## Disc Type Varistor for Surge Protection



### ■ Safety Approvals

| Certified Model No. | Agency  |   |   |   |
|---------------------|---|---|---|---|
|                     |  |  |  |  |
|                     | UL1449 4 <sup>th</sup> & cUL  | EN/IEC 61051-1, IEC 61051-2, IEC 61051-2-2  | IEC 61051-1 IEC 61051-2 IEC 61051-2-2   | GB/T10193 GB/T10194   |
|                     | E314979   | J50411784   | 5944  | CQC03001005165 CQC03001007654   |
| TVR05180            | √   | √   | √   | √   |
| TVR05220            | √   | √   | √   | √   |
| TVR05270            | √   | √   | √   | √   |
| TVR05330            | √   | √   | √   | √   |
| TVR05390            | √   | √   | √   | √   |
| TVR05470            | √   | √   | √   | √   |
| TVR05560            | √   | √   | √   | √   |
| TVR05680            | √   | √   | √   | √   |
| TVR05820            | √   | √   | √   | √   |
| TVR05101            | √   | √   | √   | √   |
| TVR05121            | √   | √   | √   | √   |
| TVR05151            | √   | √   | √   | √   |
| TVR05181            | √   | √   | √   | √   |
| TVR05201            | √   | √   | √   | √   |
| TVR05221            | √   | √   | √   | √   |
| TVR05241            | √   | √   | √   | √   |
| TVR05271            | √   | √   | √   | √   |
| TVR05301            | √   | √   | √   | √   |
| TVR05331            | √   | √   | √   | √   |
| TVR05361            | √   | √   | √   | √   |
| TVR05391            | √   | √   | √   | √   |
| TVR05431            | √   | √   | √   | √   |
| TVR05471            | √   | √   | √   | √   |
| TVR05511            | √   | √   | √   | √   |
| TVR05561            | √   | √   | √   | √   |
| TVR05621            | √   | √   | √   | √   |
| TVR05681            | √   | √   | √   | √   |
| TVR05751            | √   | √   | √   | √   |

Note:





1. UL/cUL/TUV/CQC certification: Operating Temperature is 105°C

VDE certification: Operating Temperature is 85°C; 105°C rating is under application.

# Metal Oxide Varistor : TVR Series

## Disc Type Varistor for Surge Protection



| Certified Model No. | Agency  |   |  |   |
|---------------------|---|---|--|---|
|                     |  |  |                               |  |
|                     | UL1449 4 <sup>th</sup> & cUL  | EN/IEC 61051-1,<br>IEC 61051-2,<br>IEC 61051-2-2                                  | IEC 61051-1<br>IEC 61051-2<br>IEC 61051-2-2  | GB/T10193<br>GB/T10194  |
| E314979             | J50411784   | 5944  | Current No.:<br>CQC03001005165<br>CQC03001007654<br>New No.: (Refer to Note)<br>CQC18001199806<br>CQC18001199789 |   |
| TVR07180            | √   | √   | √  | √   |
| TVR07220            | √   | √   | √  | √   |
| TVR07270            | √   | √   | √  | √   |
| TVR07330            | √   | √   | √  | √   |
| TVR07390            | √   | √   | √  | √   |
| TVR07470            | √   | √   | √  | √   |
| TVR07560            | √   | √   | √  | √   |
| TVR07680            | √   | √   | √  | √   |
| TVR07820            | √   | √   | √  | √   |
| TVR07101            | √   | √   | √  | √   |
| TVR07121            | √   | √   | √  | √   |
| TVR07151            | √   | √   | √  | √   |
| TVR07181            | √   | √   | √  | √   |
| TVR07201            | √   | √   | √  | √   |
| TVR07221            | √   | √   | √  | √   |
| TVR07241            | √   | √   | √  | √   |
| TVR07271            | √   | √   | √  | √   |
| TVR07301            | √   | √   | √  | √   |
| TVR07331            | √   | √   | √  | √   |
| TVR07361            | √   | √   | √  | √   |
| TVR07391            | √   | √   | √  | √   |
| TVR07431            | √   | √   | √  | √   |
| TVR07471            | √   | √   | √  | √   |
| TVR07511            | √   | √   | √  | √   |
| TVR07561            | √   | √   | √  | √   |
| TVR07621            | √   | √   | √  | √   |
| TVR07681            | √   | √   | √  | √   |
| TVR07751            | √   | √   | √  | √   |
| TVR07821            | √   | √   | √  | √   |





**Note:**

1. For CQC certification, its current and New numbers are both effective. However, its current number will be canceled on 2019/12/31, and only its NEW number will be available from 2020/01/01. Please use NEW number as your first priority.
2. UL/cUL/TUV/CQC certification: Operating Temperature is 105°C  
VDE certification: Operating Temperature is 85°C; 105°C rating is under application.

# Metal Oxide Varistor : TVR Series

## Disc Type Varistor for Surge Protection



| Certified Model No. | Agency  |   |  |   |
|---------------------|---|---|--|---|
|                     |  |  |                             |  |
|                     | UL1449 4 <sup>th</sup> & cUL  | EN/IEC 61051-1,<br>IEC 61051-2,<br>IEC 61051-2-2                                  | IEC 61051-1<br>IEC 61051-2<br>IEC 61051-2-2  | GB/T10193<br>GB/T10194  |
| E314979             | J50411784   | 5944  | Current No.<br>CQC03001005165<br>CQC03001007654<br>New No: (Refer to Note)<br>CQC18001200336<br>CQC18001199790 |   |
| TVR10180            | √   | √   | √  | √   |
| TVR10220            | √   | √   | √  | √   |
| TVR10270            | √   | √   | √  | √   |
| TVR10330            | √   | √   | √  | √   |
| TVR10390            | √   | √   | √  | √   |
| TVR10470            | √   | √   | √  | √   |
| TVR10560            | √   | √   | √  | √   |
| TVR10680            | √   | √   | √  | √   |
| TVR10820            | √   | √   | √  | √   |
| TVR10101            | √   | √   | √  | √   |
| TVR10121            | √   | √   | √  | √   |
| TVR10151            | √   | √   | √  | √   |
| TVR10181            | √   | √   | √  | √   |
| TVR10201            | √   | √   | √  | √   |
| TVR10221            | √   | √   | √  | √   |
| TVR10241            | √   | √   | √  | √   |
| TVR10271            | √   | √   | √  | √   |
| TVR10301            | √   | √   | √  | √   |
| TVR10331            | √   | √   | √  | √   |
| TVR10361            | √   | √   | √  | √   |
| TVR10391            | √   | √   | √  | √   |
| TVR10431            | √   | √   | √  | √   |
| TVR10471            | √   | √   | √  | √   |
| TVR10511            | √   | √   | √  | √   |
| TVR10561            | √   | √   | √  | √   |
| TVR10621            | √   | √   | √  | √   |
| TVR10681            | √   | √   | √  | √   |
| TVR10751            | √   | √   | √  | √   |
| TVR10821            | √   | √   | √  | √   |
| TVR10911            | √   | √   | √  | √   |
| TVR10102            | √   | √   | √  | √   |
| TVR10112            | √   | √   | √  | √   |
| TVR10122            | √   | √   | √  | √   |
| TVR10142            | √   | √   | √  | √   |
| TVR10162            | √   | √   | √  | √   |
| TVR10182            | √   | √   | √  | √   |

Note:

1. For CQC certification, its current and New numbers are both effective. However, its current number will be canceled on 2019/12/31, and only its NEW number will be available from 2020/01/01. Please use NEW number as your first priority.
2. UL/cUL/TUV/CQC certification: Operating Temperature is 105°C  
VDE certification: Operating Temperature is 85°C; 105°C rating is under application.

# Metal Oxide Varistor : TVR Series



## Disc Type Varistor for Surge Protection

| Certified Model No. | Agency                       |  |  |  |  |                                |                            |
|---------------------|------------------------------|--|--|--|--|--------------------------------|----------------------------|
|                     |                              |  |  |  |  |                                |                            |
|                     | UL1449 4 <sup>th</sup> & cUL | EN/IEC 61051-1, IEC 61051-2, IEC 61051-2-2 | IEC/EN 60950-1 Annex Q, IEC/EN 62368-1 Annex G.8.2 | EN/IEC 61051-1, IEC 61051-2, IEC 61051-2-2 | IEC 62368-1 Annex G.8.2  | GB/T10193-1997, GB/T10194-1997 | GB8898-2011, GB4943.1-2011 |
| E314979             | J50411784                    |  | 5944   |  | Current No.<br>CQC03001005165<br>CQC03001007654<br>New No: (Refer to Note)<br>CQC18001199842<br>CQC18001198951 |                                |                            |
| TVR14180            | √                            | √  |  | √  |  | √                              |                            |
| TVR14220            | √                            | √  |  | √  |  | √                              |                            |
| TVR14270            | √                            | √  |  | √  |  | √                              |                            |
| TVR14330            | √                            | √  |  | √  |  | √                              |                            |
| TVR14390            | √                            | √  |  | √  |  | √                              |                            |
| TVR14470            | √                            | √  |  | √  |  | √                              |                            |
| TVR14560            | √                            | √  |  | √  |  | √                              |                            |
| TVR14680            | √                            | √  |  | √  |  | √                              |                            |
| TVR14820            | √                            | √  |  | √  |  | √                              |                            |
| TVR14101            | √                            | √  |  | √  |  | √                              |                            |
| TVR14121            | √                            | √  |  | √  |  | √                              |                            |
| TVR14151            | √                            | √  |  | √  |  | √                              |                            |
| TVR14181            | √                            | √  | √  | √  | √  | √                              |                            |
| TVR14201            | √                            | √  | √  | √  | √  | √                              | √                          |
| TVR14221            | √                            | √  | √  | √  | √  | √                              | √                          |
| TVR14241            | √                            | √  | √  | √  | √  | √                              | √                          |
| TVR14271            | √                            | √  | √  | √  | √  | √                              | √                          |
| TVR14301            | √                            | √  | √  | √  | √  | √                              | √                          |
| TVR14331            | √                            | √  | √  | √  | √  | √                              | √                          |
| TVR14361            | √                            | √  | √  | √  | √  | √                              | √                          |
| TVR14391            | √                            | √  | √  | √  | √  | √                              | √                          |
| TVR14431            | √                            | √  | √  | √  | √  | √                              | √                          |
| TVR14471            | √                            | √  | √  | √  | √  | √                              | √                          |
| TVR14511            | √                            | √  | √  | √  | √  | √                              | √                          |
| TVR14561            | √                            | √  | √  | √  | √  | √                              | √                          |
| TVR14621            | √                            | √  | √  | √  | √  | √                              | √                          |
| TVR14681            | √                            | √  | √  | √  | √  | √                              | √                          |
| TVR14751            | √                            | √  | √  | √  | √  | √                              | √                          |
| TVR14821            | √                            | √  | √  | √  | √  | √                              | √                          |
| TVR14911            | √                            | √  | √  | √  | √  | √                              | √                          |
| TVR14102            | √                            | √  | √  | √  | √  | √                              | √                          |
| TVR14112            | √                            | √  | √  | √  | √  | √                              | √                          |
| TVR14122            | √                            | √  | √  | √  | √  | √                              | √                          |
| TVR14142            | √                            | √  | √  | √  | √  | √                              | √                          |
| TVR14162            | √                            | √  | √  | √  | √  | √                              | √                          |
| TVR14182            | √                            | √  | √  | √  | √  | √                              | √                          |

**Note:**

1. For CQC certification, its current and New numbers are both effective. However, its current number will be canceled on 2019/12/31, and only its NEW number will be available from 2020/01/01. Please use NEW number as your first priority.
2. UL/cUL/TUV/CQC certification: Operating Temperature is 105°C  
VDE certification: Operating Temperature is 85°C; 105°C rating is under application.

# Metal Oxide Varistor : TVR Series



## Disc Type Varistor for Surge Protection

| Certified Model No. | Agency                       |  |   |  |  |                               |                           |
|---------------------|------------------------------|--|---|--|--|-------------------------------|---------------------------|
|                     |                              |  |   |  |  |                               |                           |
|                     | UL1449 4 <sup>th</sup> & cUL | EN/IEC 61051-1, IEC 61051-2, IEC 61051-2-2 | IEC/EN 60950-1 Annex Q IEC/EN 62368-1 Annex G.8.2 | EN/IEC 61051-1, IEC 61051-2, IEC 61051-2-2 | IEC 62368-1 Annex G.8.2  | GB/T10193-1997 GB/T10194-1997 | GB8898-2011 GB4943.1-2011 |
| E314979             | J50411784                    |  | 5944  |  | Current No.<br>CQC03001005165<br>CQC03001007654<br>New No: (Refer to Note)<br>CQC18001199807<br>CQC18001198952 |                               |                           |
| TVR20180            | √                            | √  |   | √  |  | √                             |                           |
| TVR20220            | √                            | √  |   | √  |  | √                             |                           |
| TVR20270            | √                            | √  |   | √  |  | √                             |                           |
| TVR20330            | √                            | √  |   | √  |  | √                             |                           |
| TVR20390            | √                            | √  |   | √  |  | √                             |                           |
| TVR20470            | √                            | √  |   | √  |  | √                             |                           |
| TVR20560            | √                            | √  |   | √  |  | √                             |                           |
| TVR20680            | √                            | √  |   | √  |  | √                             |                           |
| TVR20820            | √                            | √  |   | √  |  | √                             |                           |
| TVR20101            | √                            | √  |   | √  |  | √                             |                           |
| TVR20121            | √                            | √  |   | √  |  | √                             |                           |
| TVR20151            | √                            | √  |   | √  |  | √                             |                           |
| TVR20181            | √                            | √  | √   | √  | √  | √                             |                           |
| TVR20201            | √                            | √  | √   | √  | √  | √                             | √                         |
| TVR20221            | √                            | √  | √   | √  | √  | √                             | √                         |
| TVR20241            | √                            | √  | √   | √  | √  | √                             | √                         |
| TVR20271            | √                            | √  | √   | √  | √  | √                             | √                         |
| TVR20301            | √                            | √  | √   | √  | √  | √                             | √                         |
| TVR20331            | √                            | √  | √   | √  | √  | √                             | √                         |
| TVR20361            | √                            | √  | √   | √  | √  | √                             | √                         |
| TVR20391            | √                            | √  | √   | √  | √  | √                             | √                         |
| TVR20431            | √                            | √  | √   | √  | √  | √                             | √                         |
| TVR20471            | √                            | √  | √   | √  | √  | √                             | √                         |
| TVR20511            | √                            | √  | √   | √  | √  | √                             | √                         |
| TVR20561            | √                            | √  | √   | √  | √  | √                             | √                         |
| TVR20621            | √                            | √  | √   | √  | √  | √                             | √                         |
| TVR20681            | √                            | √  | √   | √  | √  | √                             | √                         |
| TVR20751            | √                            | √  | √   | √  | √  | √                             | √                         |
| TVR20821            | √                            | √  | √   | √  | √  | √                             | √                         |
| TVR20911            | √                            | √  | √   | √  | √  | √                             | √                         |
| TVR20102            | √                            | √  | √   | √  | √  | √                             | √                         |
| TVR20112            | √                            | √  | √   | √  | √  | √                             | √                         |
| TVR20122            | √                            | √  | √   | √  | √  | √                             | √                         |
| TVR20142            | √                            | √  | √   | √  | √  | √                             | √                         |
| TVR20162            | √                            | √  | √   | √  | √  | √                             | √                         |
| TVR20182            | √                            | √  | √   | √  | √  | √                             | √                         |

**Note:**

1. For CQC certification, its current and New numbers are both effective. However, its current number will be canceled on 2019/12/31, and only its NEW number will be available from 2020/01/01. Please use NEW number as your first priority.
2. UL/cUL/TUV/CQC certification: Operating Temperature is 105°C  
VDE certification: Operating Temperature is 85°C; 105°C rating is under application.

# Metal Oxide Varistor : TVR Series



## Disc Type Varistor for Surge Protection

### Power Derating Curve

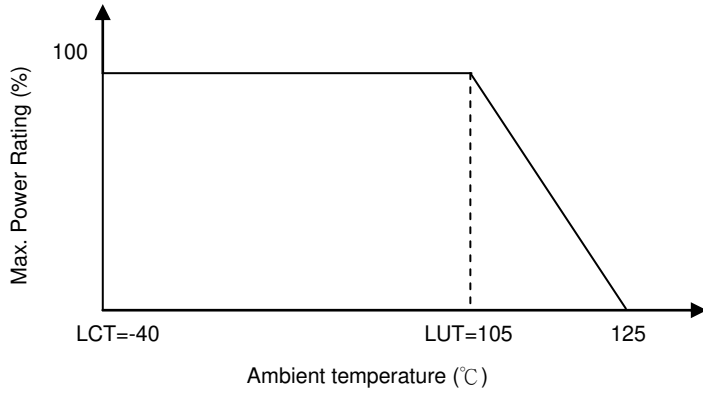

### Surge Current Standard Waveform

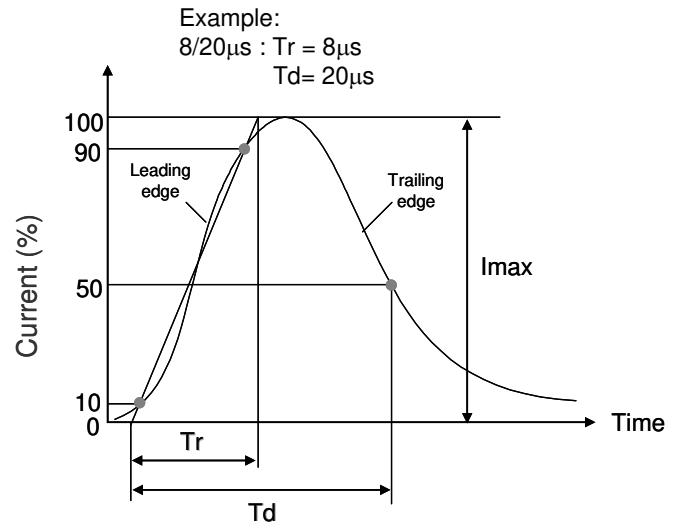

### Max. Surge Current Derating Curves

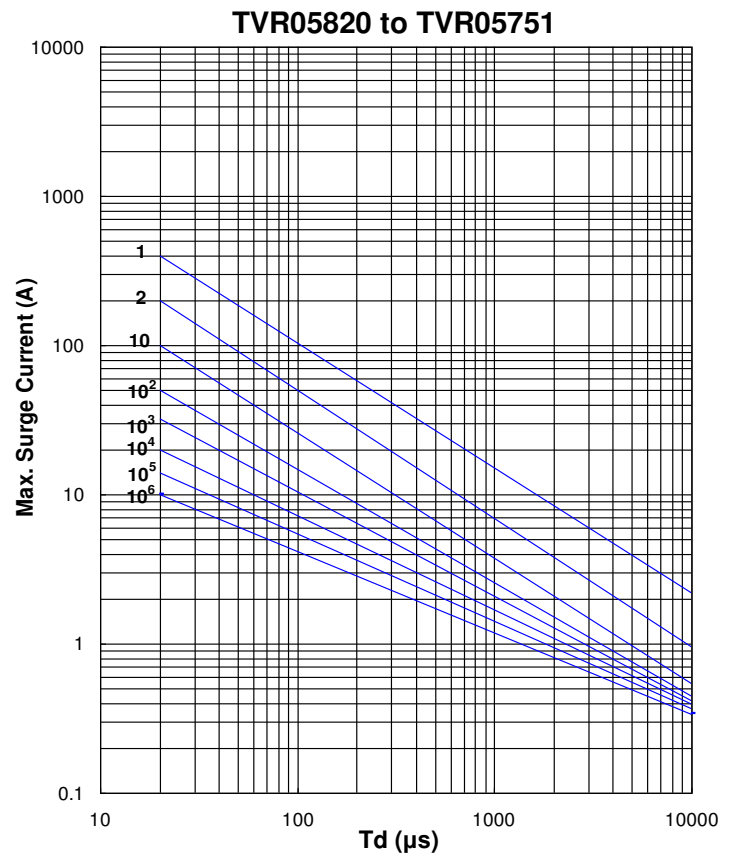
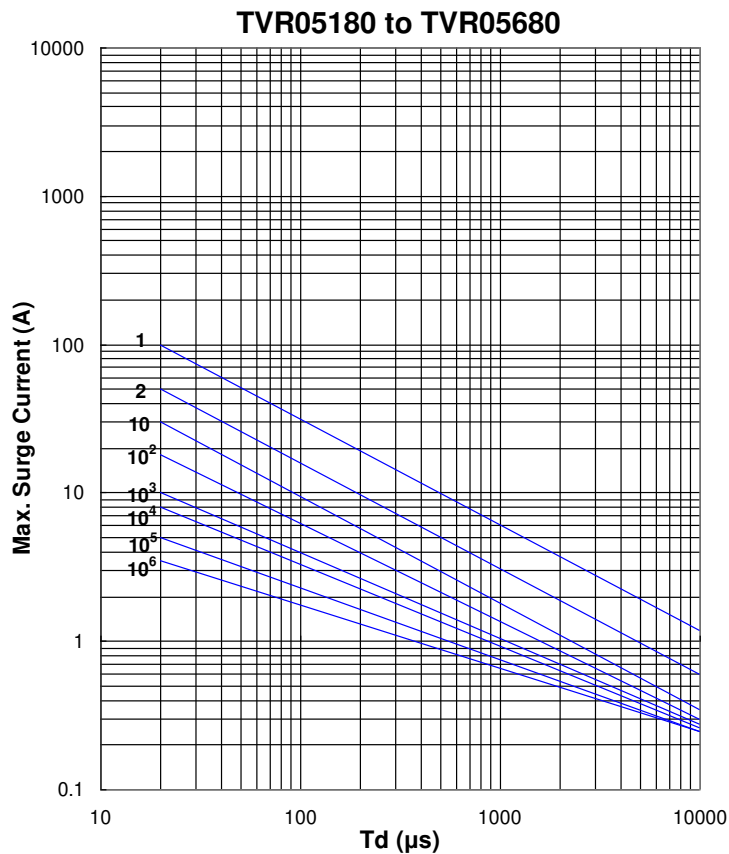

# Metal Oxide Varistor : TVR Series



## Disc Type Varistor for Surge Protection

### ■ Max. Surge Current Derating Curves

TVR07180 to TVR07680

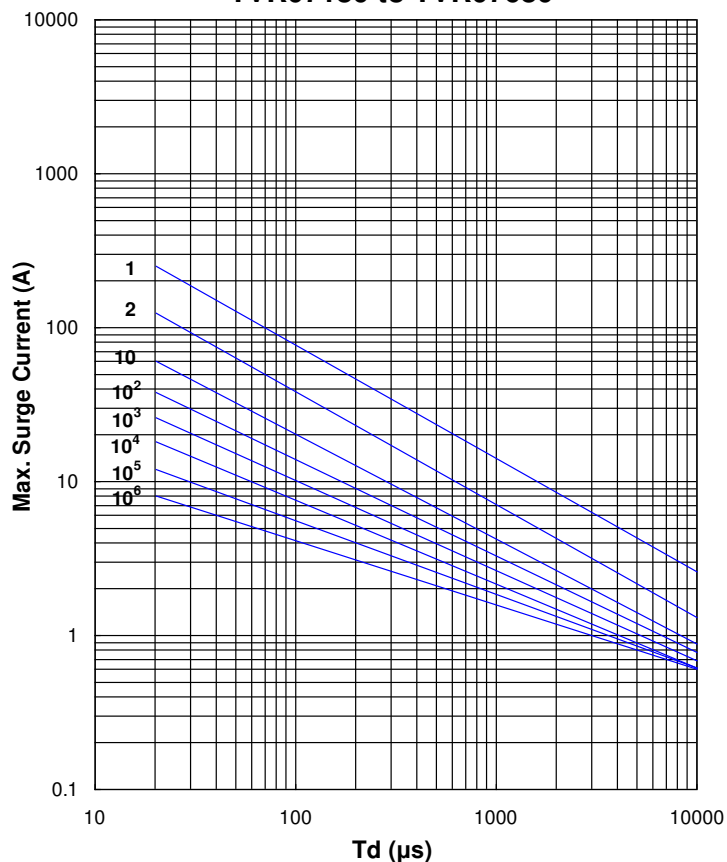

TVR07820 to TVR07471

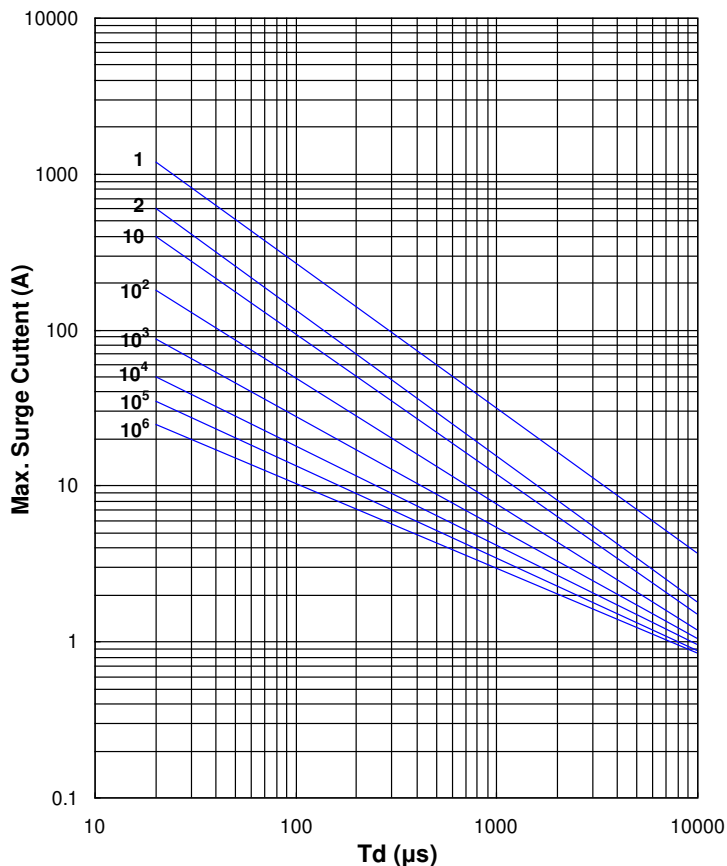

TVR07511 to TVR07821

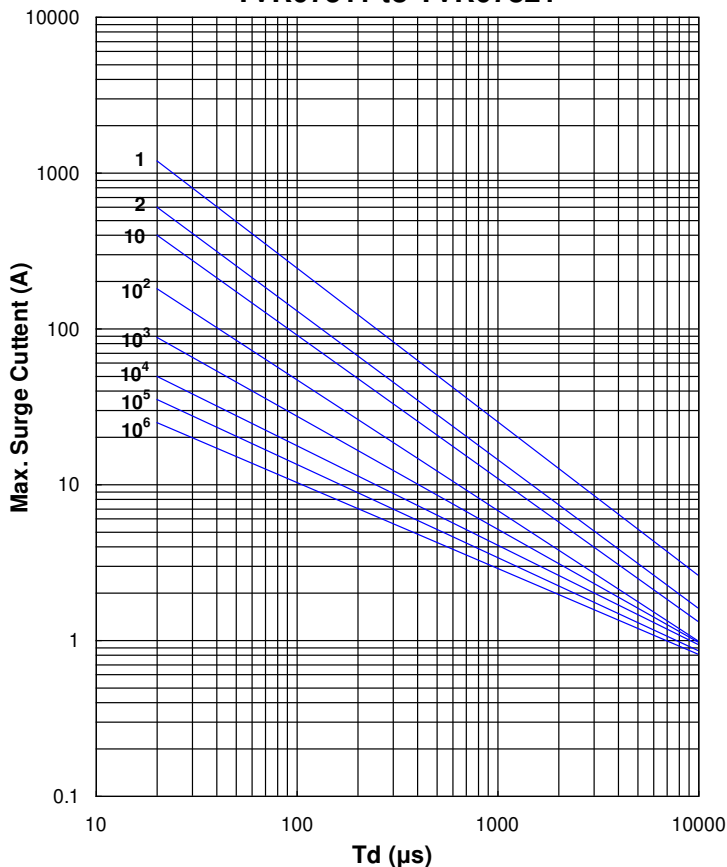

TVR10180 to TVR10680

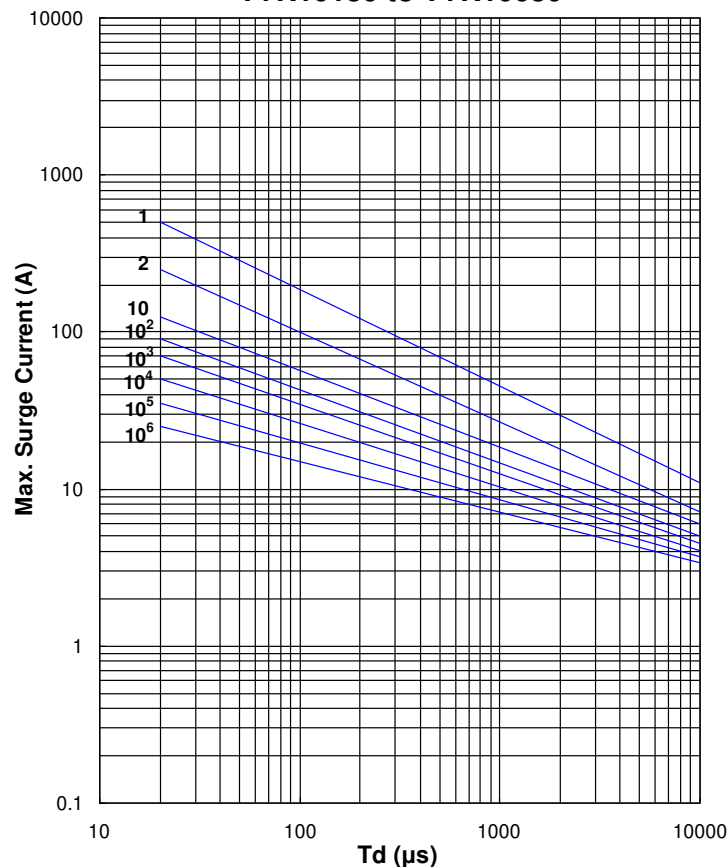

# Metal Oxide Varistor : TVR Series



## Disc Type Varistor for Surge Protection

### Max. Surge Current Derating Curves

TVR10820 to TVR10751

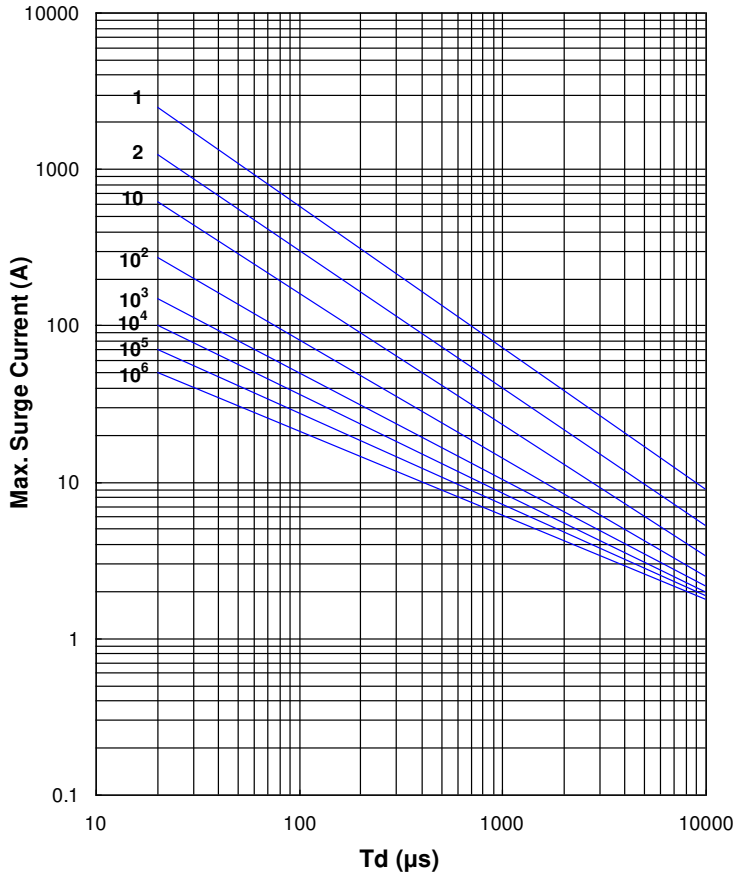

TVR10821 to TVR10182

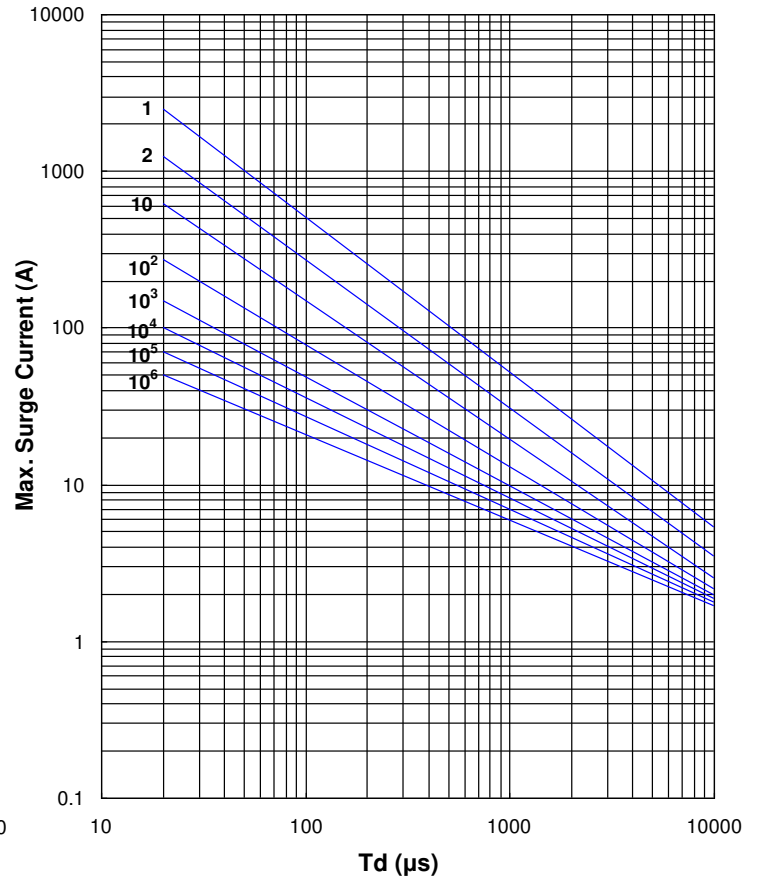

TVR14180 to TVR14680

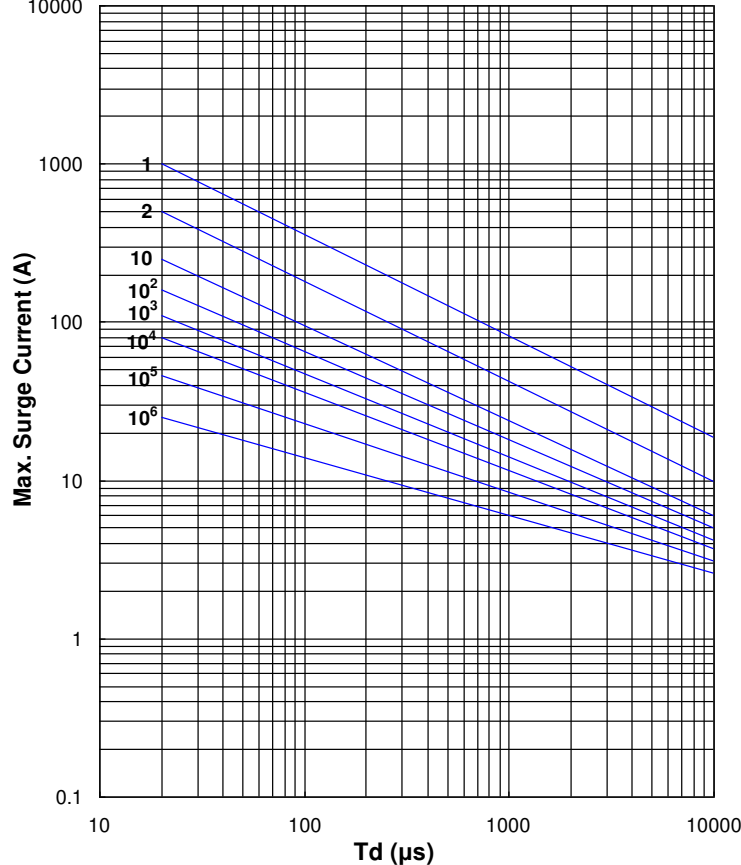

TVR14820 to TVR14751

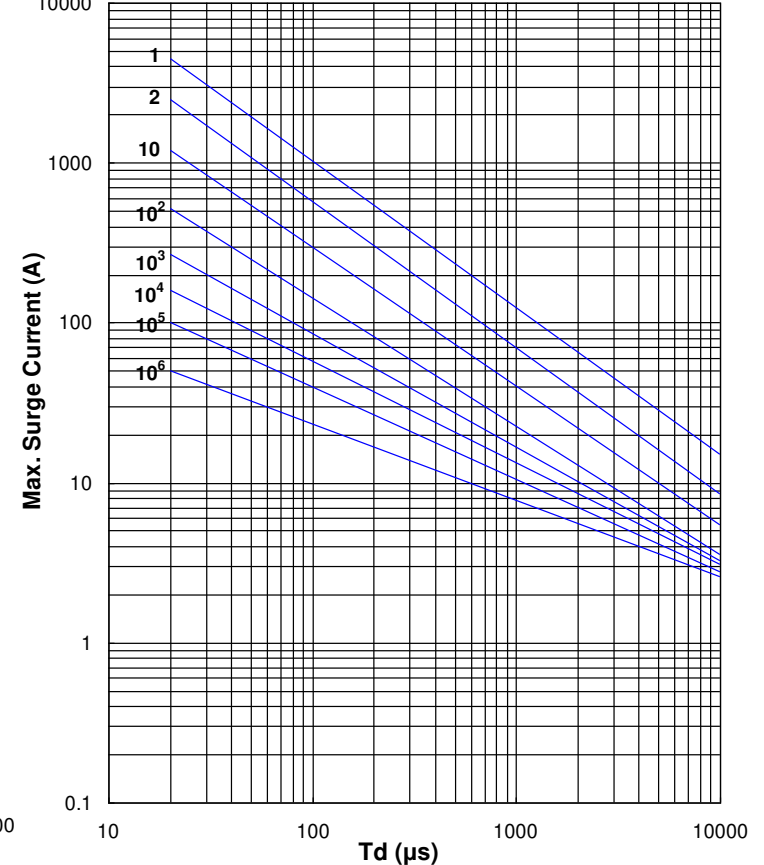



# Metal Oxide Varistor : TVR Series



## Disc Type Varistor for Surge Protection

### Max. Surge Current Derating Curves

TVR14821 to TVR14182

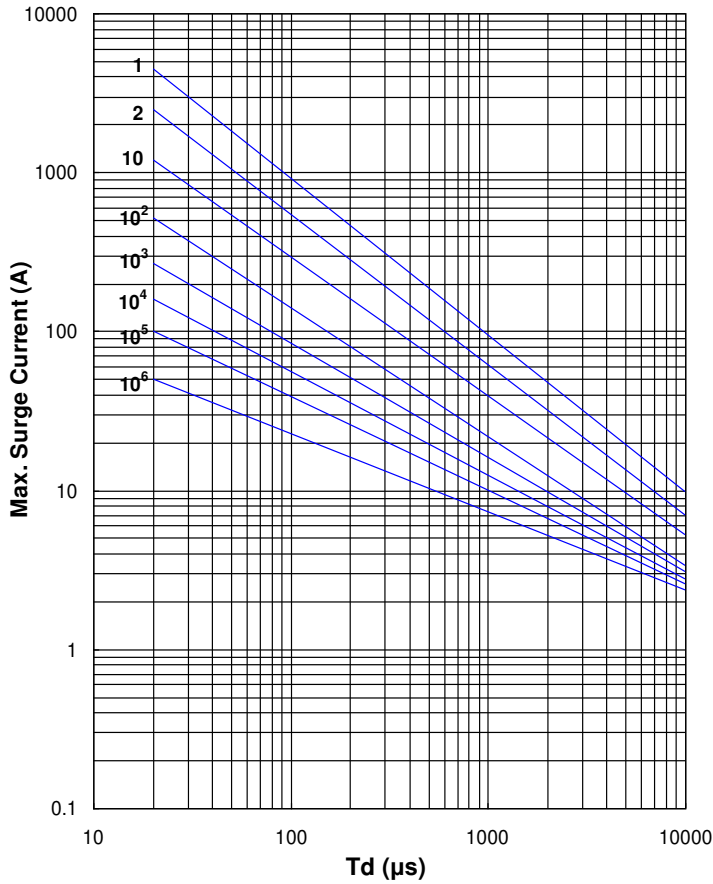

TVR20180 to TVR20680

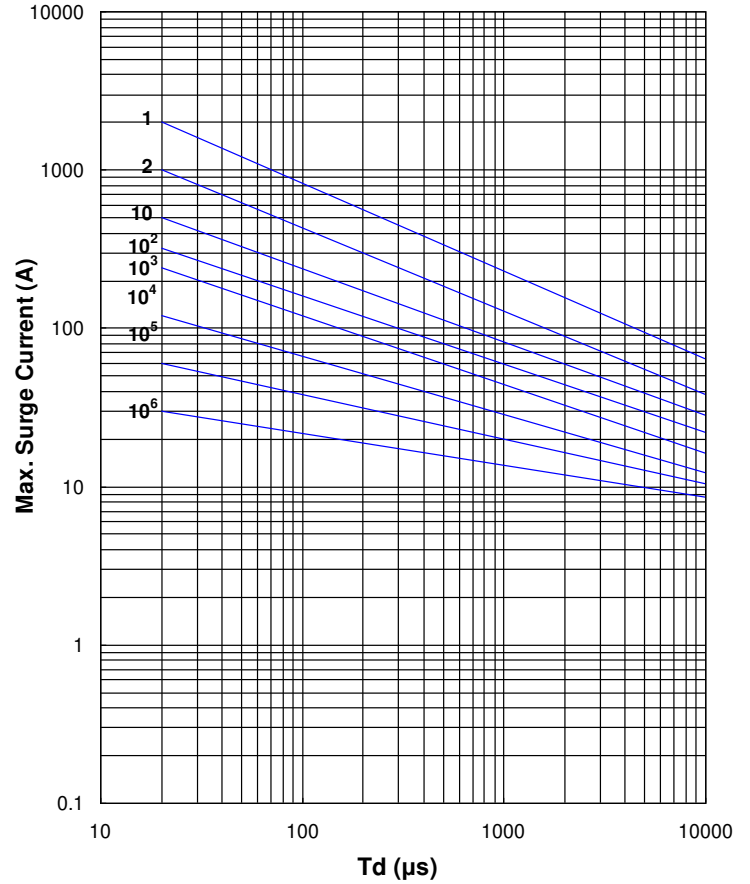

TVR20820(R) to TVR20751(R)

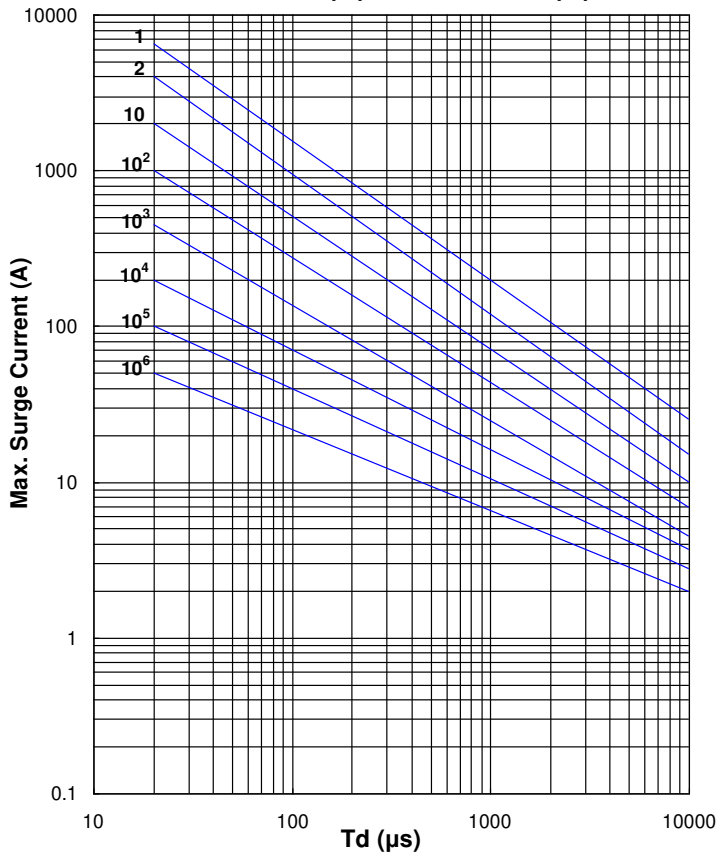

TVR20821(R) to TVR20182(R)

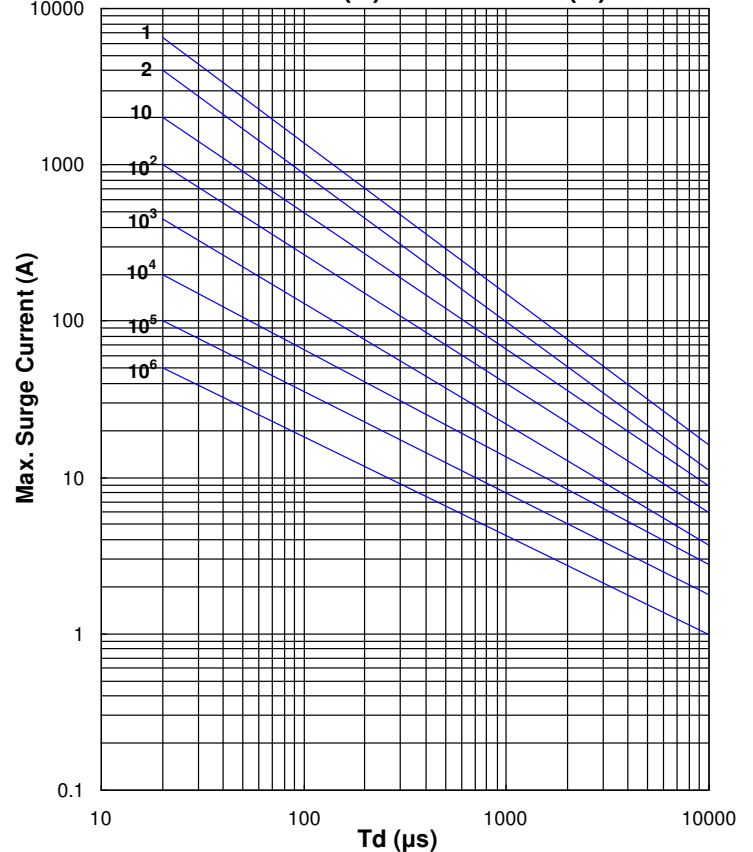

# Metal Oxide Varistor : TVR Series

## Disc Type Varistor for Surge Protection



### ■ Max. Leakage Current and Max. Clamping Voltage Curves

Max. Leakage Current and Max. Clamping Voltage Curves (TVR05180 to TVR05680)

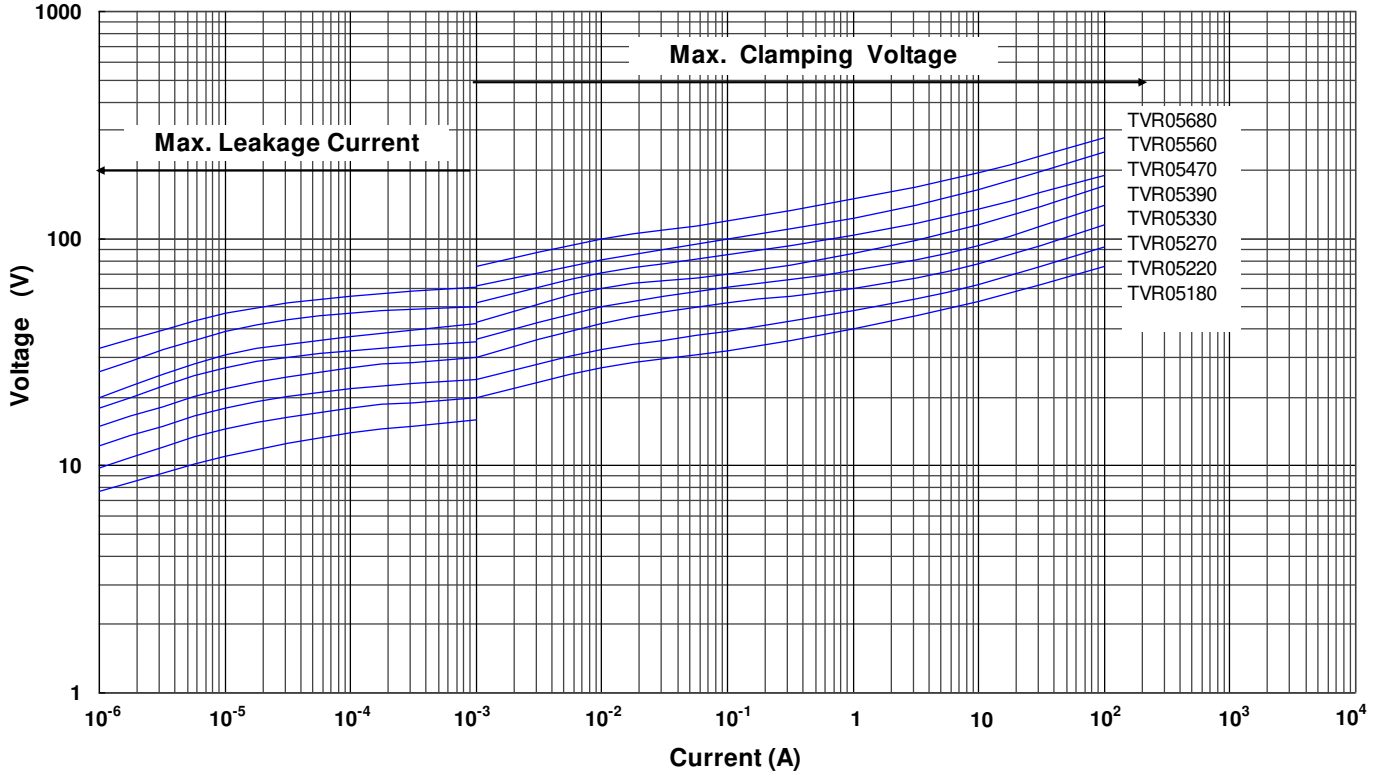

Max. Leakage Current and Max. Clamping Voltage Curves (TVR05820 to TVR05751)

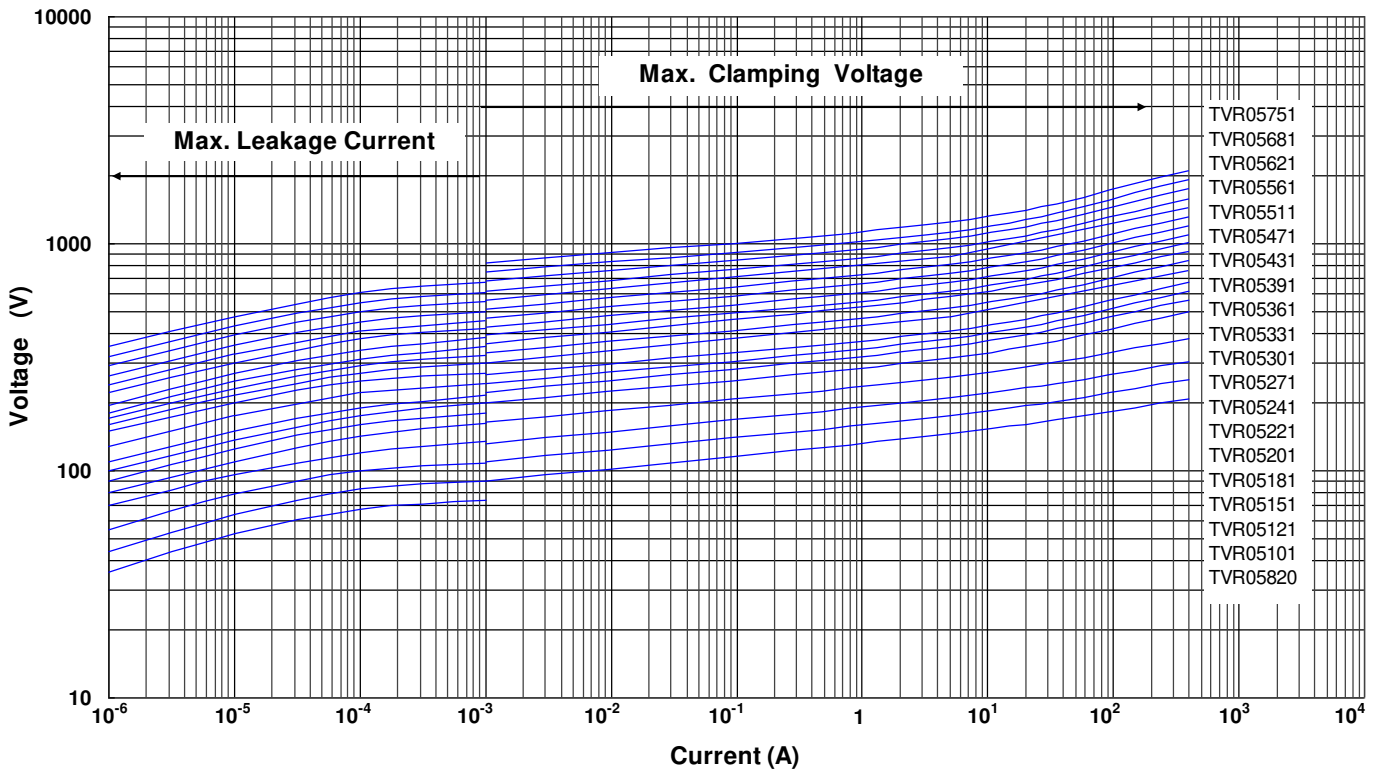

# Metal Oxide Varistor : TVR Series



## Disc Type Varistor for Surge Protection

### ■ Max. Leakage Current and Max. Clamping Voltage Curves

Max. Leakage Current and Max. Clamping Voltage Curves (TVR07180 to TVR07680)

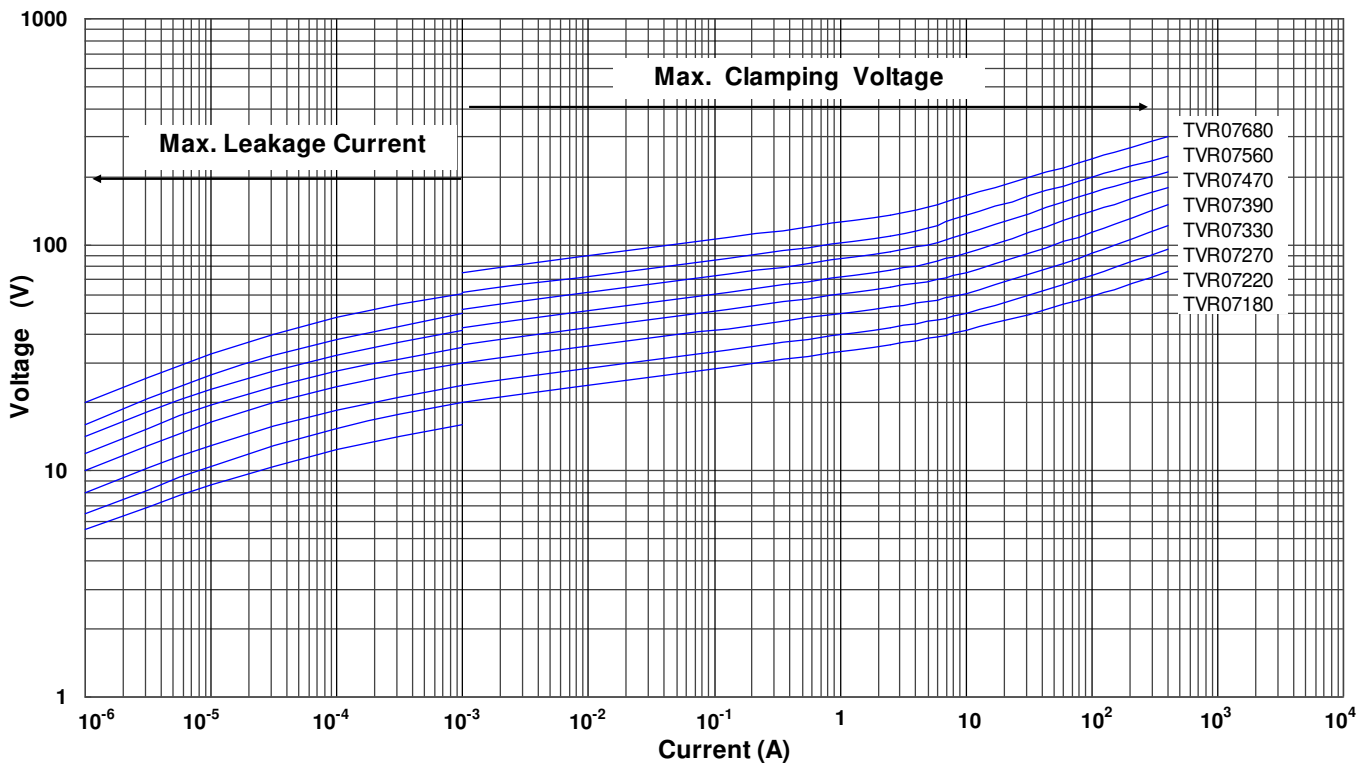

Max. Leakage Current and Max. Clamping Voltage Curves (TVR07820 to TVR07471)

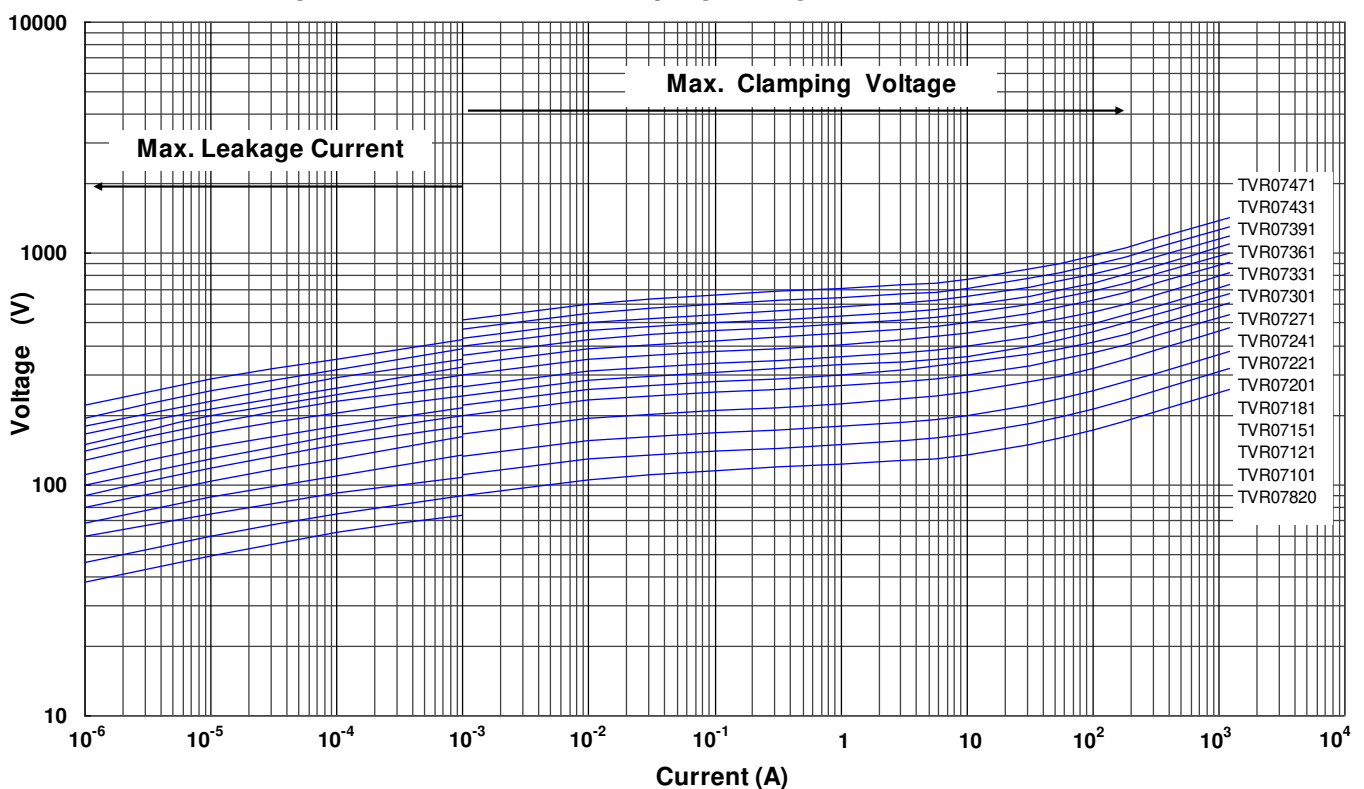

# Metal Oxide Varistor : TVR Series



## Disc Type Varistor for Surge Protection

### ■ Max. Leakage Current and Max. Clamping Voltage Curves

Max. Leakage Current and Max. Clamping Voltage Curves (TVR07511 to TVR07821)

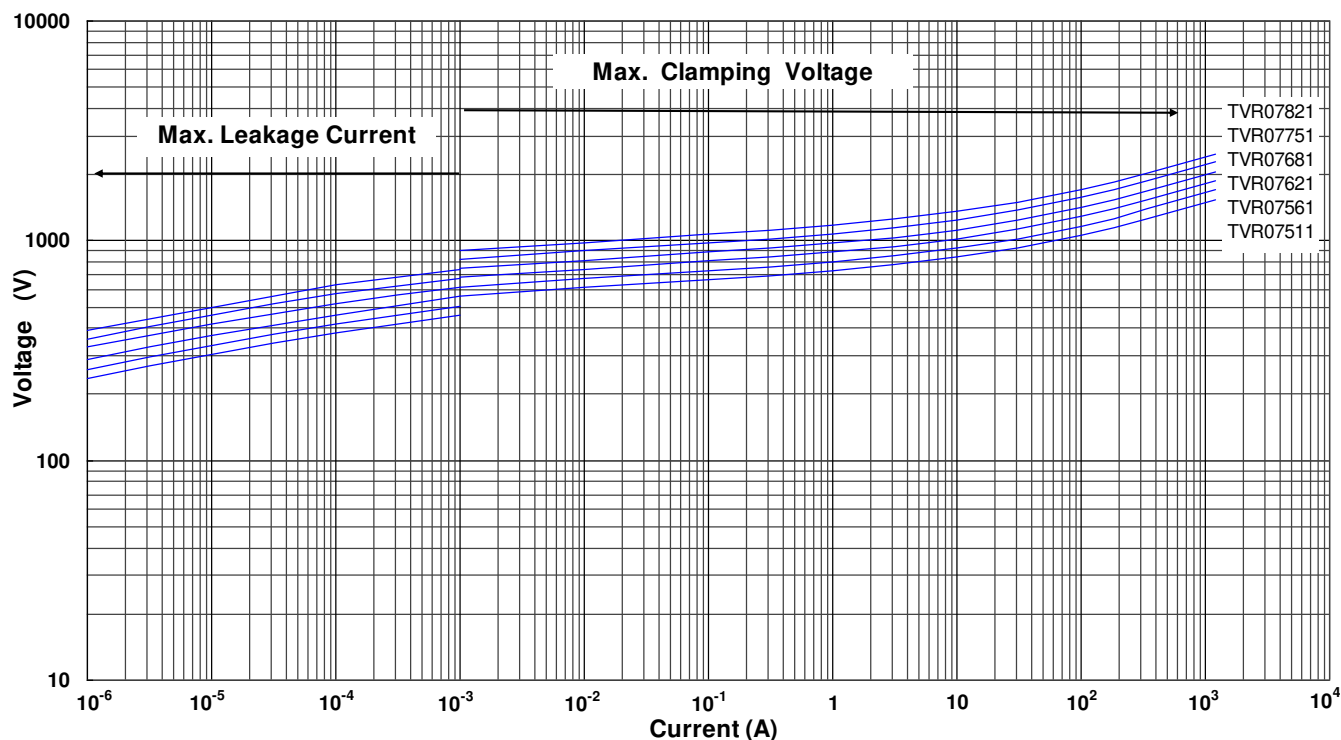

Max. Leakage Current and Max. Clamping Voltage Curves (TVR10180 to TVR10680)

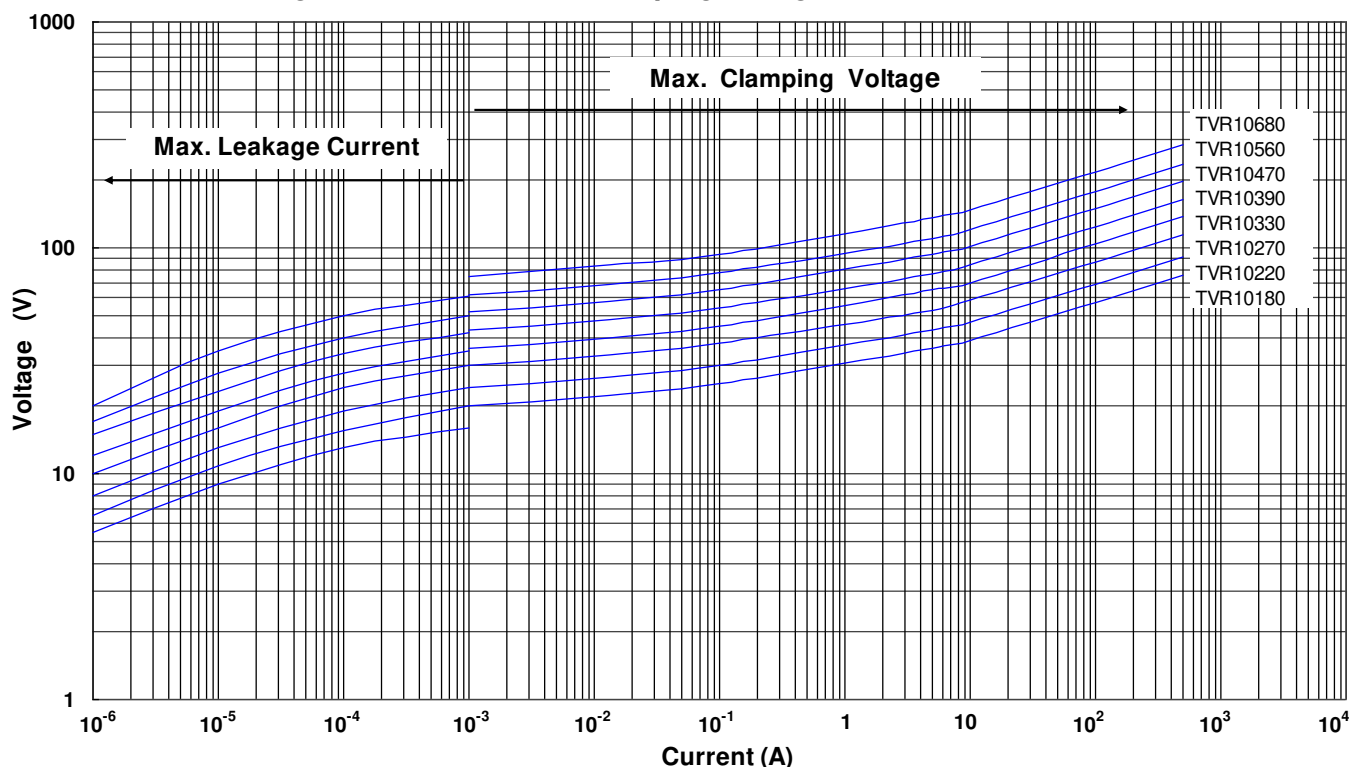

# Metal Oxide Varistor : TVR Series



## Disc Type Varistor for Surge Protection

### ■ Max. Leakage Current and Max. Clamping Voltage Curves

Max. Leakage Current and Max. Clamping Voltage Curves (TVR10820 to TVR10471)

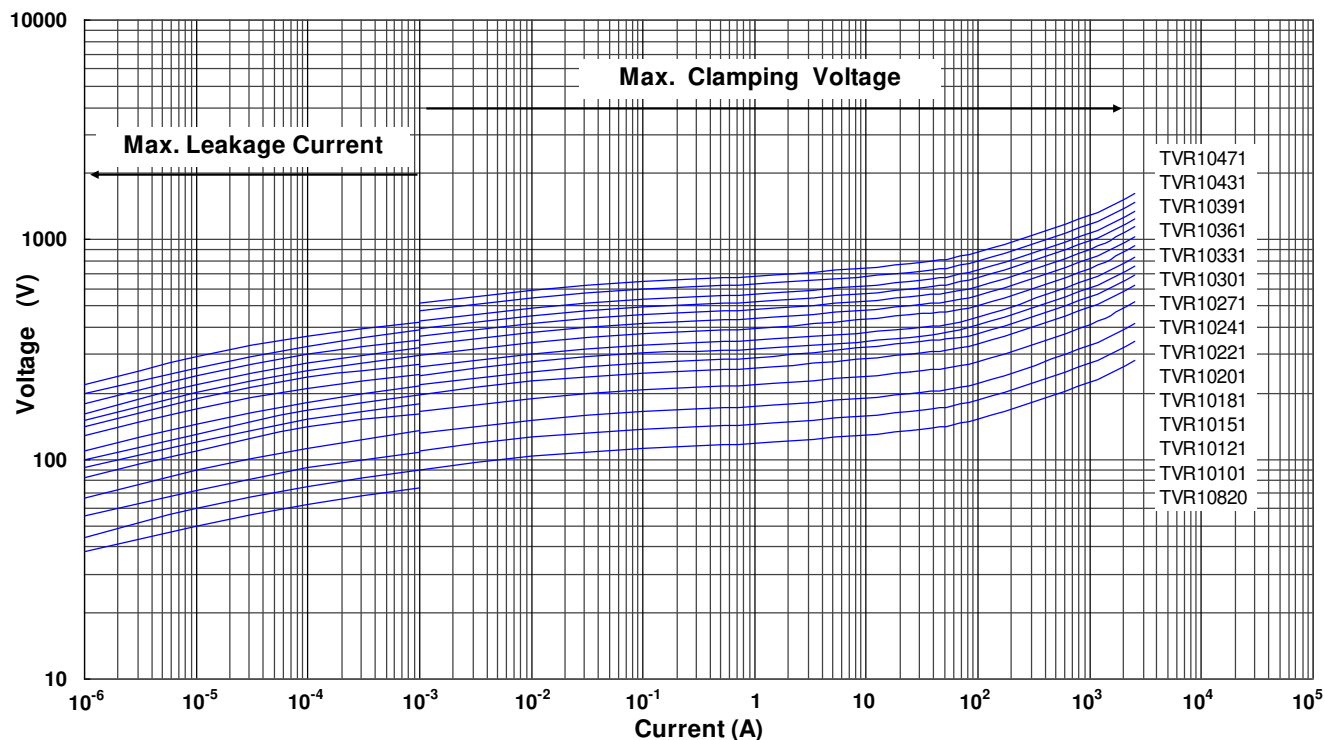

Max. Leakage Current and Max. Clamping Voltage Curves (TVR10511 to TVR10182)

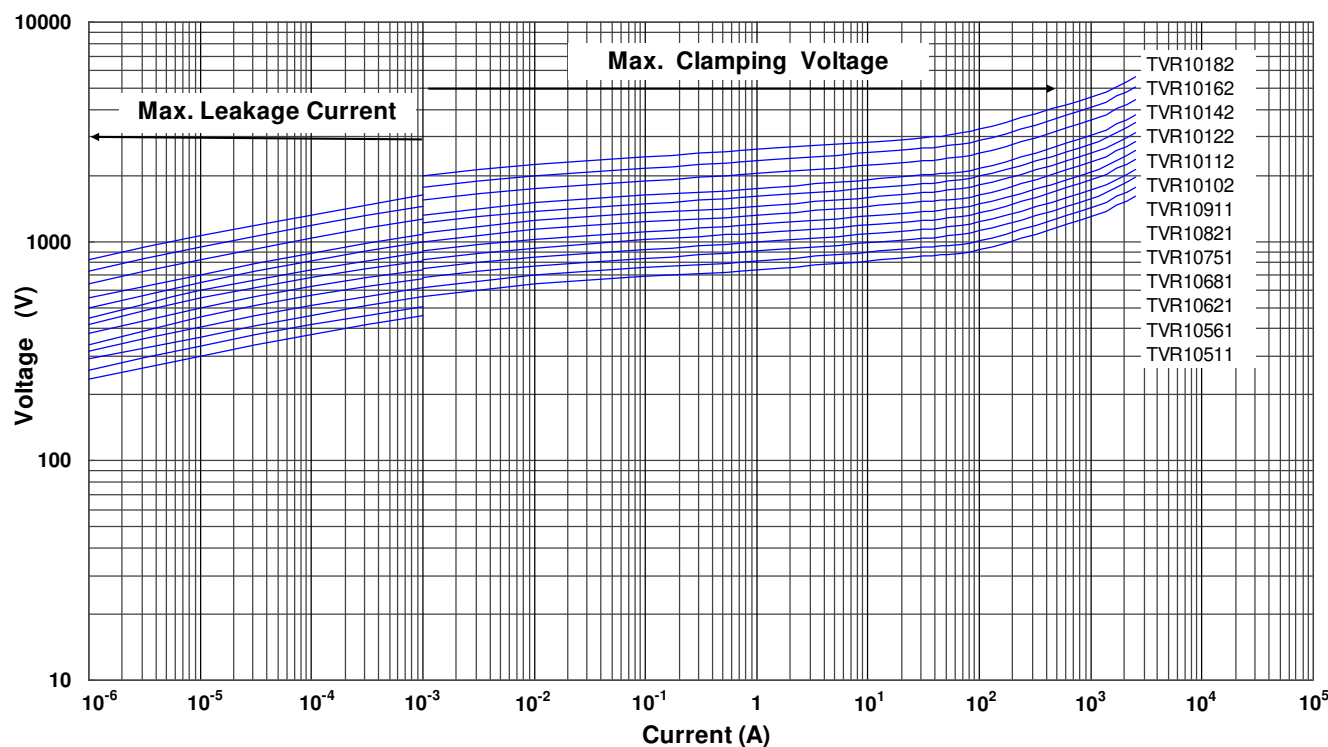

# Metal Oxide Varistor : TVR Series

## Disc Type Varistor for Surge Protection



### ■ Max. Leakage Current and Max. Clamping Voltage Curves

Max. Leakage Current and Max. Clamping Voltage Curves (TVR14180 to TVR14680)

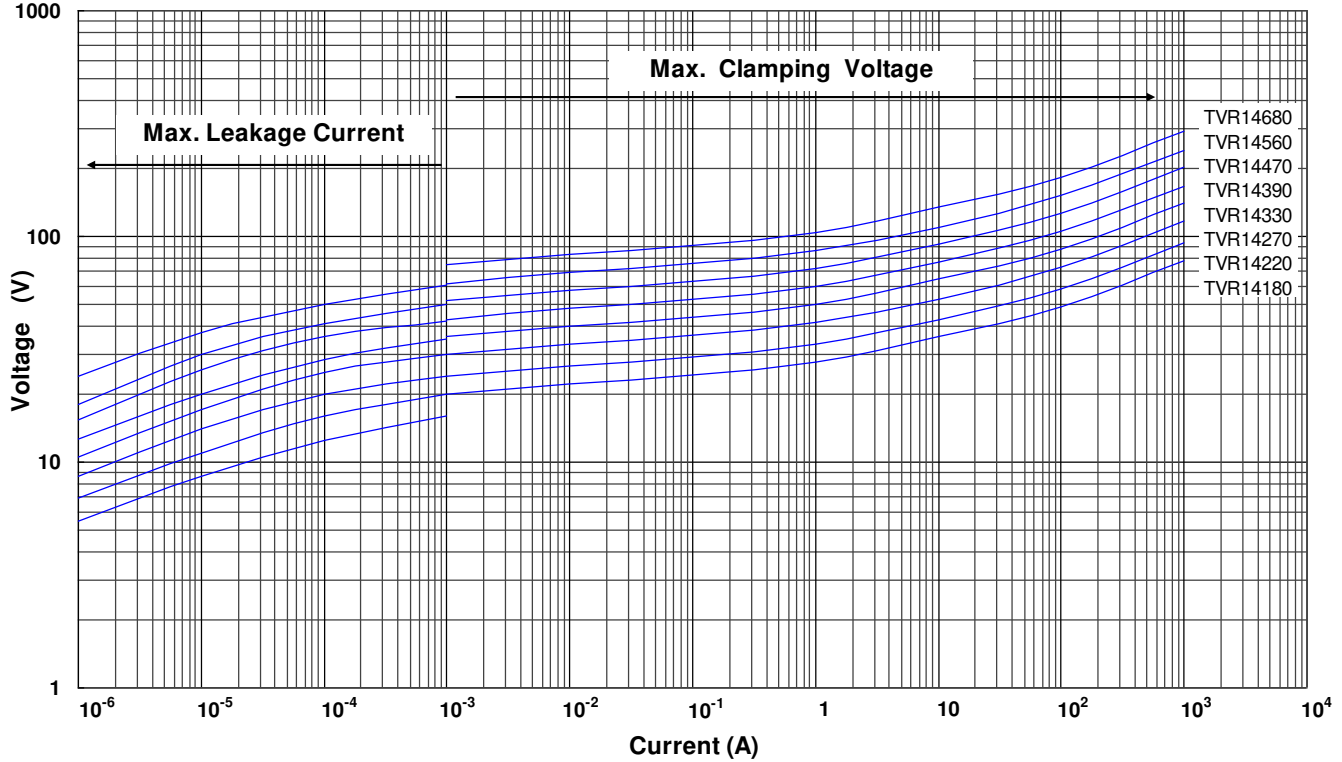

Max. Leakage Current and Max. Clamping Voltage Curves (TVR14820 to TVR14471)

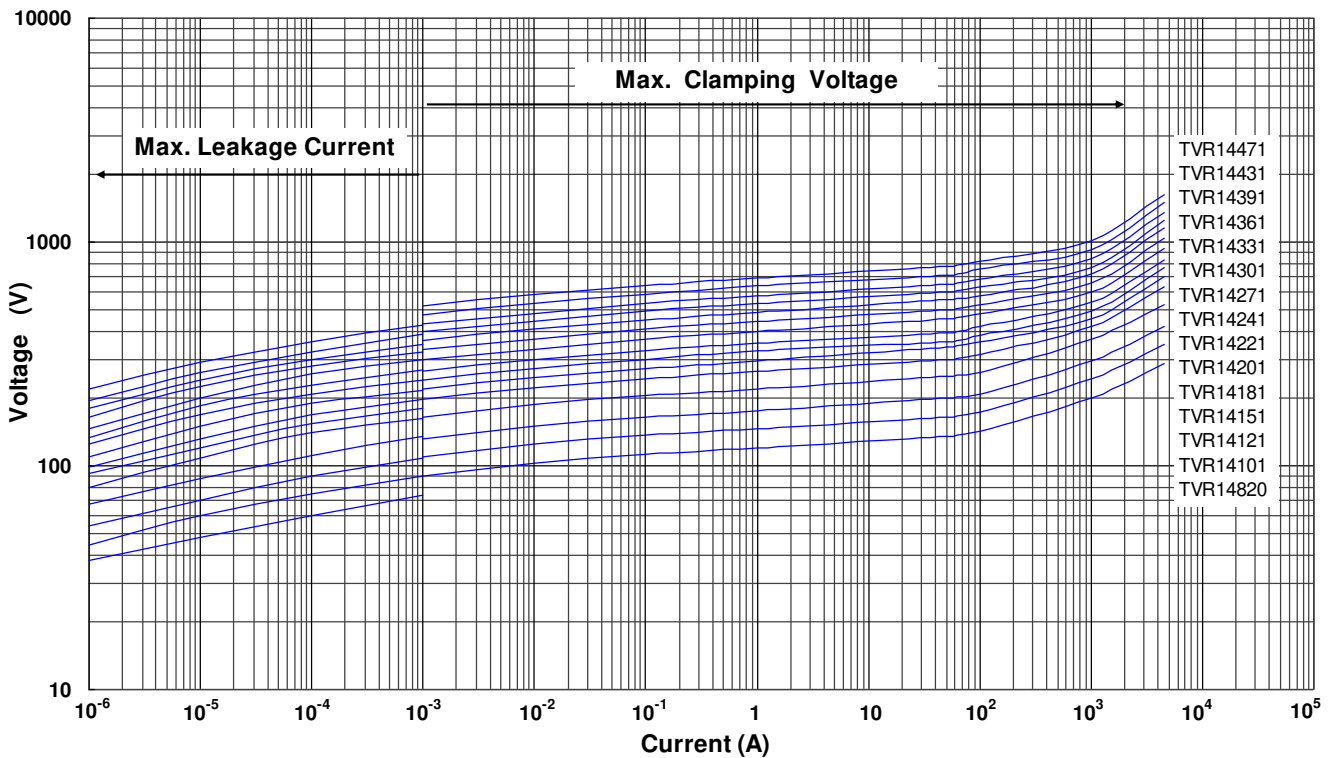

# Metal Oxide Varistor : TVR Series



## Disc Type Varistor for Surge Protection

### ■ Max. Leakage Current and Max. Clamping Voltage Curves

Max. Leakage Current and Max. Clamping Voltage Curves (TVR14511 to TVR14182)

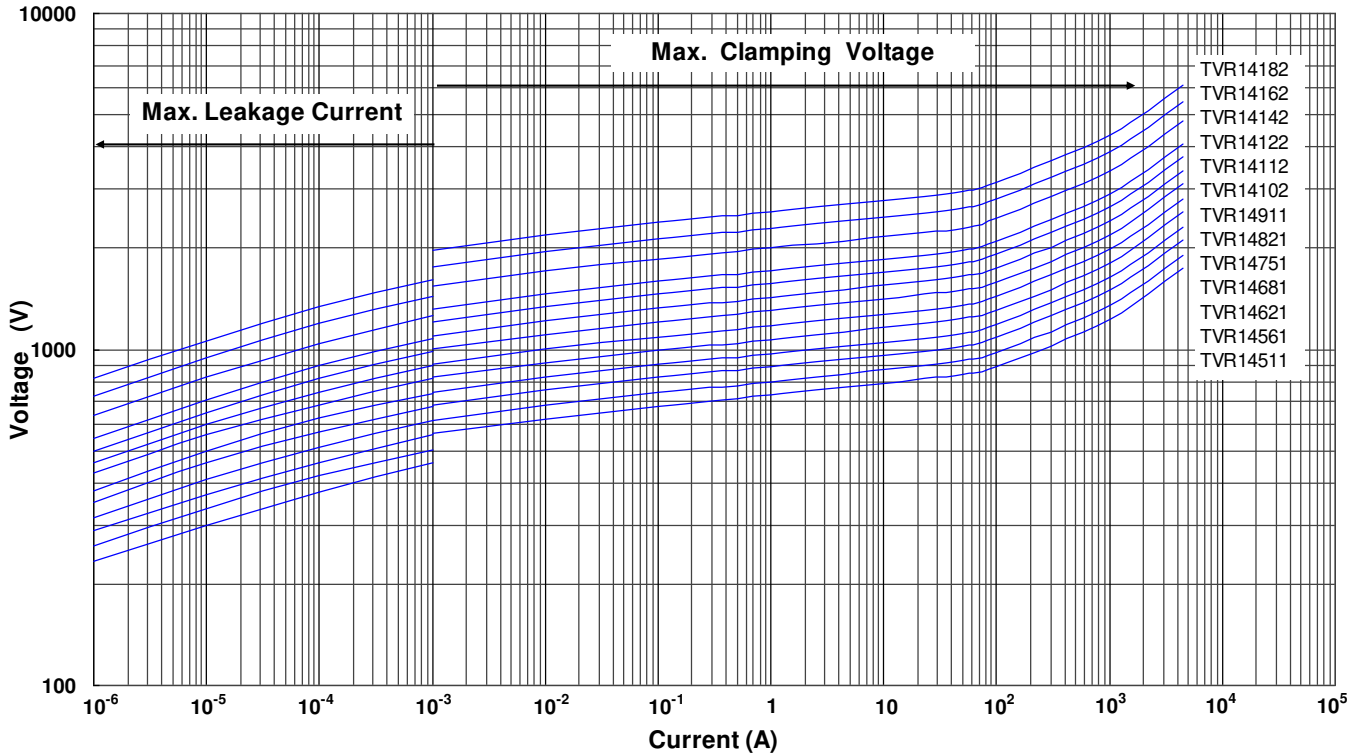

Max. Leakage Current and Max. Clamping Voltage Curves (TVR20180 to TVR20680)

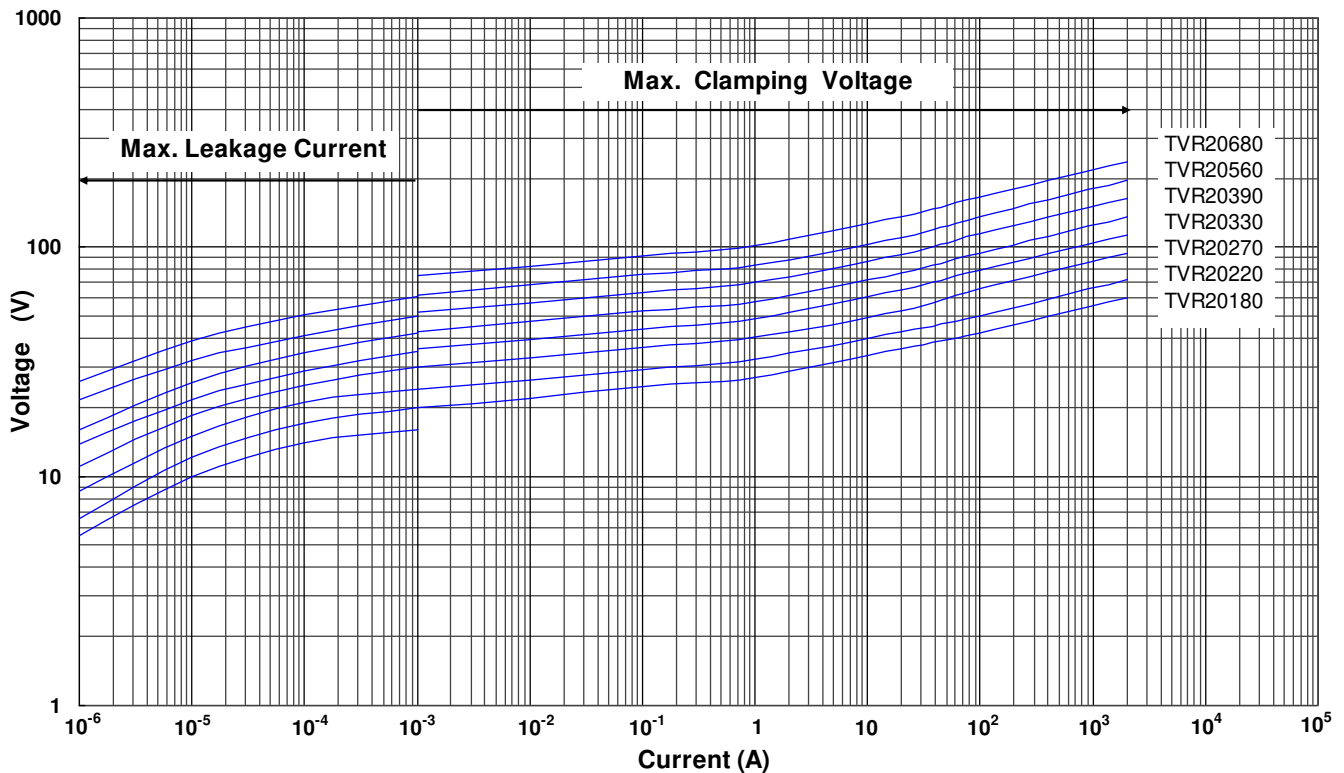

# Metal Oxide Varistor : TVR Series



## Disc Type Varistor for Surge Protection

### ■ Max. Leakage Current and Max. Clamping Voltage Curves

Max. Leakage Current and Max. Clamping Voltage Curves (TVR20820 to TVR20471)

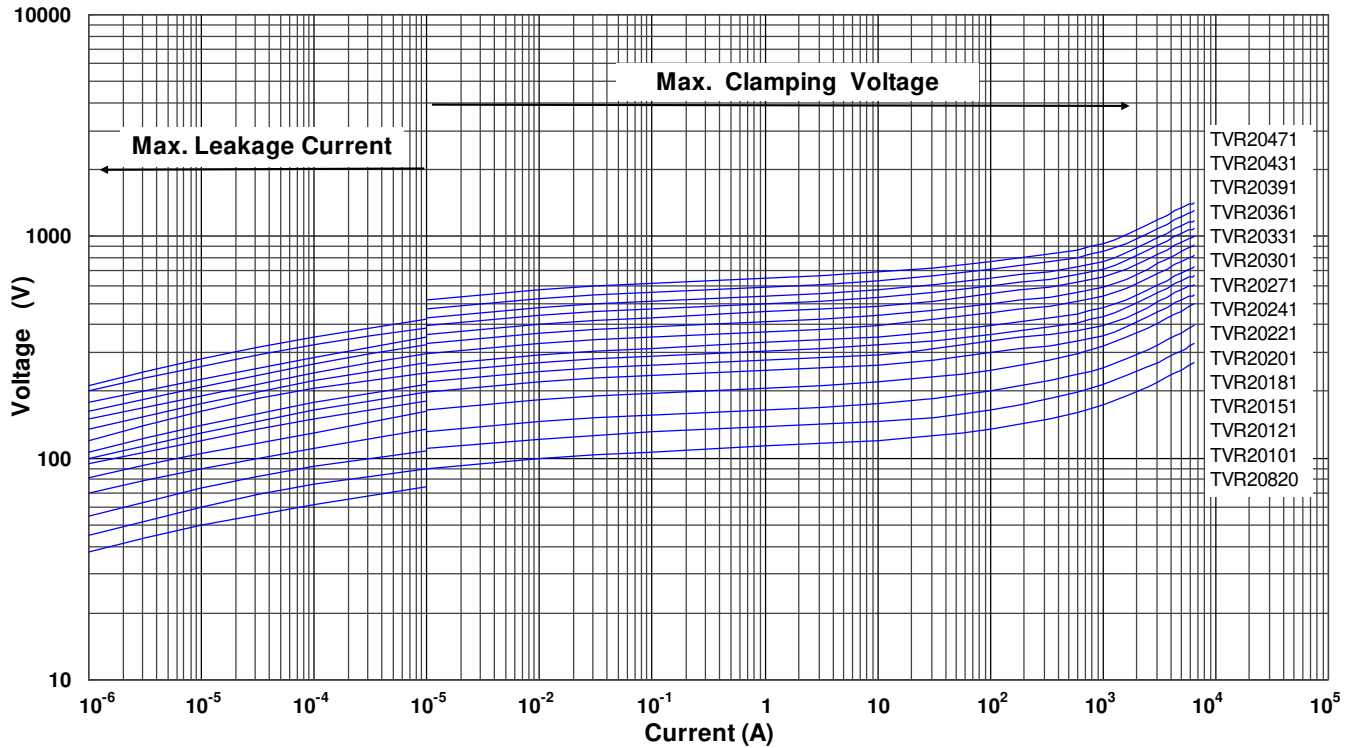

Max. Leakage Current and Max. Clamping Voltage Curves (TVR20511 to TVR20182)

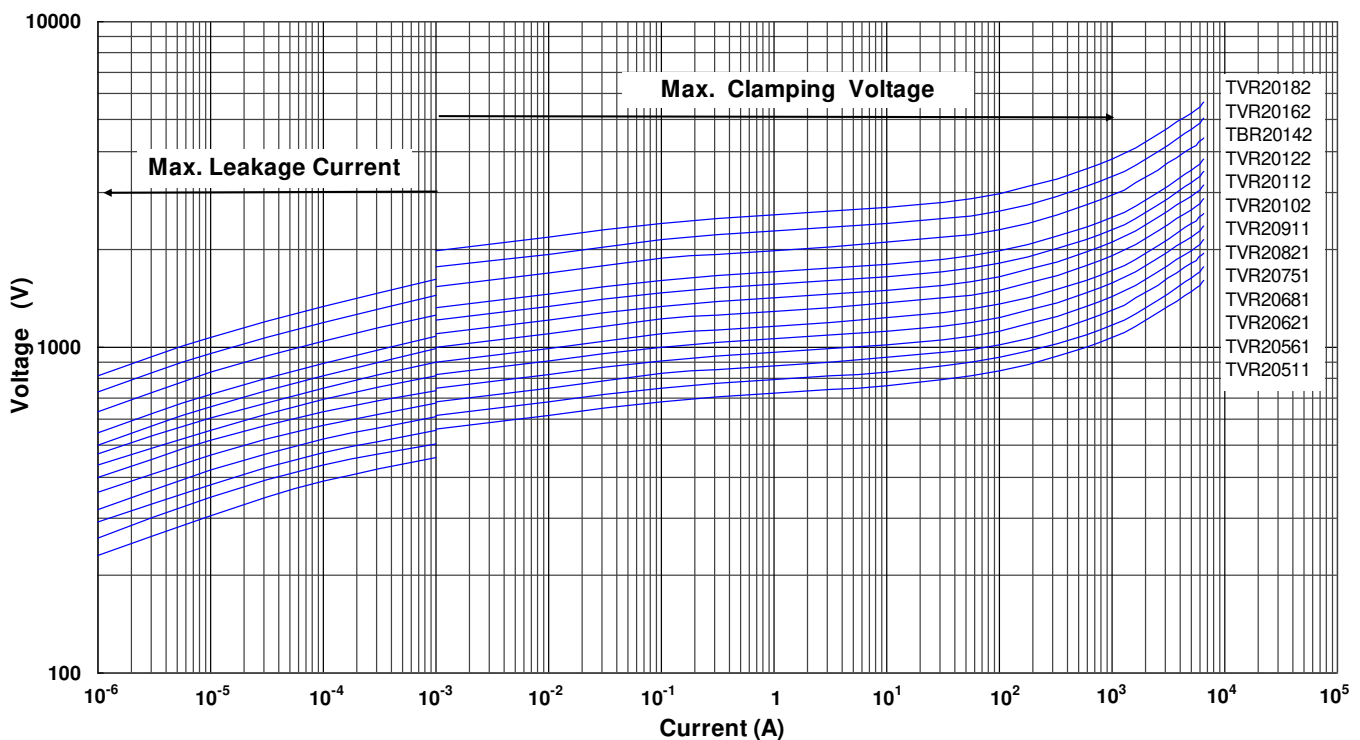



# Metal Oxide Varistor : TVR Series



## Disc Type Varistor for Surge Protection

### ■ Soldering Recommendation

#### ● Wave Soldering Profile

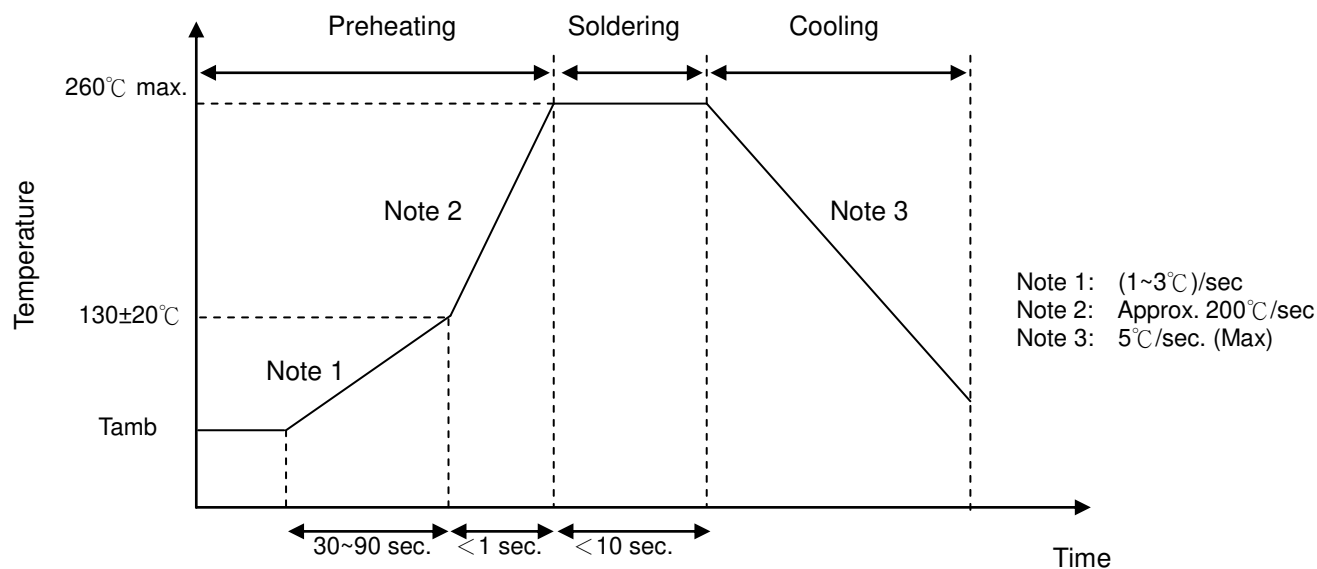

#### ● Recommended Reworking Conditions with Soldering Iron

| Item                              | Conditions                 |
|-----------------------------------|----------------------------|
| Temperature of Soldering Iron-tip | $360^\circ\text{C}$ (max.) |
| Soldering Time                    | 3 sec (max.)               |
| Distance from Varistor            | 2 mm (min.)                |



# Metal Oxide Varistor : TVR Series



## Disc Type Varistor for Surge Protection

### ■ Packaging

#### ● Taping Specification

#### S Type (Straight Lead)

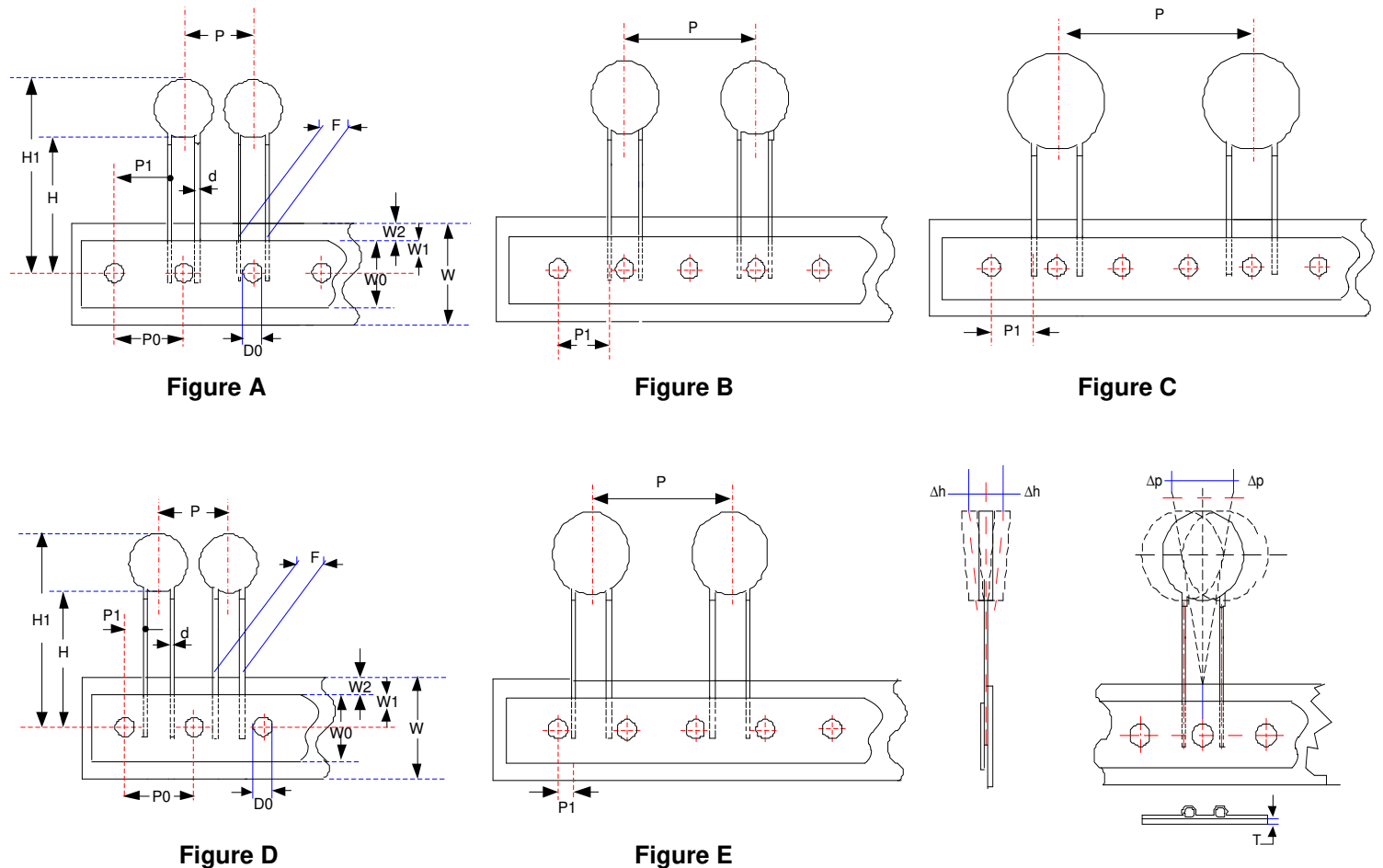

(Unit: mm)

| Taping Code                 | Body Size | P <sub>0</sub> | F    | P    | P <sub>1</sub> | H     | H <sub>1</sub> | d     | W <sub>0</sub> | W <sub>1</sub> | W <sub>2</sub> | W       | Δ P  | Δ h  | D <sub>0</sub> | T    | Figure |
|-----------------------------|-----------|----------------|------|------|----------------|-------|----------------|-------|----------------|----------------|----------------|---------|------|------|----------------|------|--------|
|                             |           | ±0.3           | ±1   | ±1   | ±1             | +2/-0 | Max.           | ±0.02 | ±1             | +0.75/-0.5     | Max            | +1/-0.5 | Max. | Max. | ±0.2           | ±0.2 |        |
| A<br>(P <sub>0</sub> :12.7) | 05        | 12.7           | 5.0  | 12.7 | 3.55           | 18    | 28.0           | 0.6   | 12             | 9              | 3              | 18      | 1    | 2    | 4              | 0.6  | D      |
|                             | 07        | 12.7           | 5.0  | 12.7 | 3.55           | 18    | 30.0           | 0.6   | 12             | 9              | 3              | 18      | 1    | 2    | 4              | 0.6  | D      |
|                             | 10        | 12.7           | 7.5  | 12.7 | 8.55           | 18    | 33.5           | 0.8   | 12             | 9              | 3              | 18      | 1    | 2    | 4              | 0.6  | A      |
|                             | 14        | 12.7           | 7.5  | 25.4 | 8.55           | 18    | 38.0           | 0.8   | 12             | 9              | 3              | 18      | 1    | 2    | 4              | 0.6  | B      |
|                             | 20        | 12.7           | 10.0 | 38.1 | 7.20           | 18    | 40.5           | 1.0   | 12             | 9              | 3              | 18      | 1    | 2    | 4              | 0.6  | C      |
| E<br>(P <sub>0</sub> :15.0) | 05        | 15             | 5.0  | 15.0 | 4.70           | 18    | 28.0           | 0.6   | 12             | 9              | 3              | 18      | 1    | 2    | 4              | 0.6  | D      |
|                             | 07        | 15             | 5.0  | 15.0 | 4.70           | 18    | 30.0           | 0.6   | 12             | 9              | 3              | 18      | 1    | 2    | 4              | 0.6  | D      |
|                             | 10        | 15             | 7.5  | 15.0 | 3.35           | 18    | 33.5           | 0.8   | 12             | 9              | 3              | 18      | 1    | 2    | 4              | 0.6  | D      |
|                             | 14        | 15             | 7.5  | 30.0 | 3.35           | 18    | 38.0           | 0.8   | 12             | 9              | 3              | 18      | 1    | 2    | 4              | 0.6  | E      |
|                             | 20        | 15             | 10.0 | 30.0 | 9.50           | 18    | 40.5           | 1.0   | 12             | 9              | 3              | 18      | 1    | 2    | 4              | 0.6  | B      |

# Metal Oxide Varistor : TVR Series

## Disc Type Varistor for Surge Protection



### F Type (Y Kink Lead)

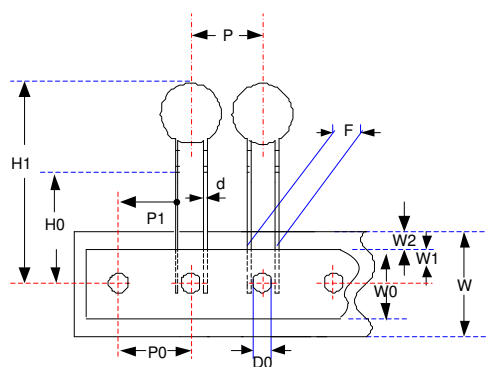

Figure A

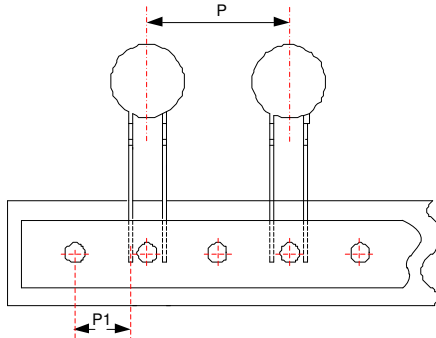

Figure B

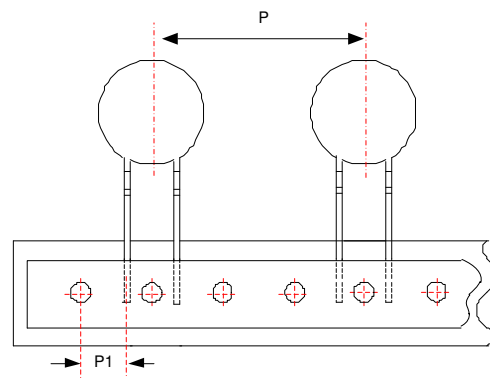

Figure C

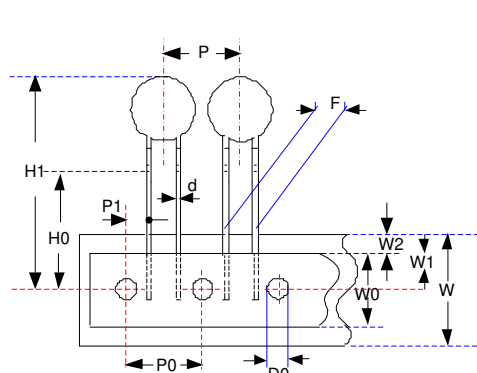

Figure D

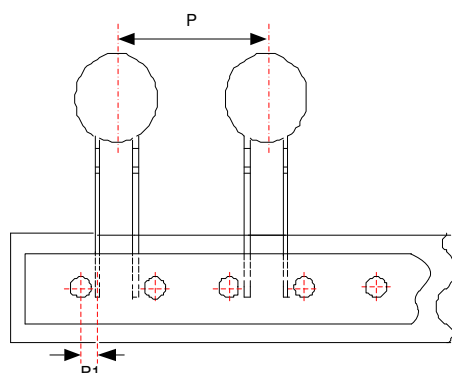
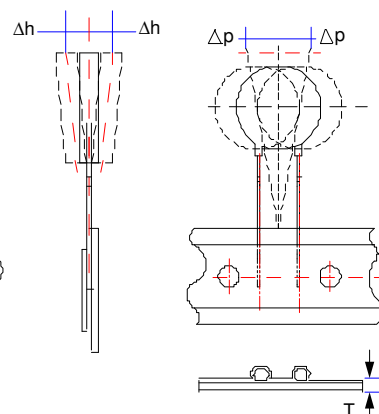

Figure E



(Unit: mm)

| Taping Code                 | Body Size | P <sub>0</sub> | F    | P    | P <sub>1</sub> | H <sub>0</sub> | H <sub>1</sub> | d     | W <sub>0</sub> | W <sub>1</sub> | W <sub>2</sub> | W       | ΔP   | Δh   | D <sub>0</sub> | T    | Figure |
|-----------------------------|-----------|----------------|------|------|----------------|----------------|----------------|-------|----------------|----------------|----------------|---------|------|------|----------------|------|--------|
|                             |           | ±0.3           | ±1   | ±1   | ±1             | ±0.5           | Max.           | ±0.02 | ±1             | +0.75/-0.5     | Max            | +1/-0.5 | Max. | Max. | ±0.2           | ±0.2 |        |
| A<br>(P <sub>0</sub> :12.7) | 05        | 12.7           | 5.0  | 12.7 | 3.55           | 16             | 28.0           | 0.6   | 12             | 9              | 3              | 18      | 1    | 2    | 4              | 0.6  | D      |
|                             | 07        | 12.7           | 5.0  | 12.7 | 3.55           | 16             | 30.0           | 0.6   | 12             | 9              | 3              | 18      | 1    | 2    | 4              | 0.6  | D      |
|                             | 10        | 12.7           | 7.5  | 12.7 | 8.55           | 16             | 33.5           | 0.8   | 12             | 9              | 3              | 18      | 1    | 2    | 4              | 0.6  | A      |
|                             | 14        | 12.7           | 7.5  | 25.4 | 8.55           | 16             | 38.0           | 0.8   | 12             | 9              | 3              | 18      | 1    | 2    | 4              | 0.6  | B      |
|                             | 20        | 12.7           | 10.0 | 38.1 | 7.20           | 16             | 44.5           | 1.0   | 12             | 9              | 3              | 18      | 1    | 2    | 4              | 0.6  | C      |
| E<br>(P <sub>0</sub> :15.0) | 05        | 15             | 5.0  | 15.0 | 4.70           | 16             | 28.0           | 0.6   | 12             | 9              | 3              | 18      | 1    | 2    | 4              | 0.6  | D      |
|                             | 07        | 15             | 5.0  | 15.0 | 4.70           | 16             | 30.0           | 0.6   | 12             | 9              | 3              | 18      | 1    | 2    | 4              | 0.6  | D      |
|                             | 10        | 15             | 7.5  | 15.0 | 3.35           | 16             | 33.5           | 0.8   | 12             | 9              | 3              | 18      | 1    | 2    | 4              | 0.6  | D      |
|                             | 14        | 15             | 7.5  | 30.0 | 3.35           | 16             | 38.0           | 0.8   | 12             | 9              | 3              | 18      | 1    | 2    | 4              | 0.6  | E      |
|                             | 20        | 15             | 10.0 | 30.0 | 9.50           | 16             | 44.5           | 1.0   | 12             | 9              | 3              | 18      | 1    | 2    | 4              | 0.6  | B      |

# Metal Oxide Varistor : TVR Series



## Disc Type Varistor for Surge Protection

### ■ Quantity

#### ● Bulk Packing

| Series          | Straight Lead Type<br>Quantity (pcs/bag) | Cut Lead Type<br>Quantity (pcs/bag) | Kink Type<br>Quantity (pcs/bag) |
|-----------------|--|-------------------------------------|---------------------------------|
| TVR05           | 250                                      | 250                                 | ---                             |
| TVR07           | 250                                      | 250                                 | 200                             |
| TVR10 (180~751) | 200                                      | 200                                 | 200                             |
| TVR10 (821~182) | 100                                      | 100                                 | 100                             |
| TVR14           | 100                                      | 100                                 | 100                             |
| TVR20           | 50                                       | 50                                  | 50                              |

#### ● Reel Packing

| Series         | A (mm) | Quantity (pcs/reel) |
|----------------|--------|---------------------|
| TVR05(180~391) | 46     | 1,500               |
| TVR05(431~751) |        | 1,000               |
| TVR07(180~391) |        | 1,500               |
| TVR07(431~821) |        | 1,000               |
| TVR10(180~911) |        | 1,000               |
| TVR10(102~112) |        | 750                 |
| TVR10(122~182) |        | 500                 |
| TVR14(180~470) |        | 800                 |
| TVR14(560~391) |        | 750                 |
| TVR14(431~182) |        | 500                 |
| TVR20(180~431) | 52     | 500                 |
| TVR20(471~681) |        | 400                 |
| TVR20(751~182) |        | 250                 |

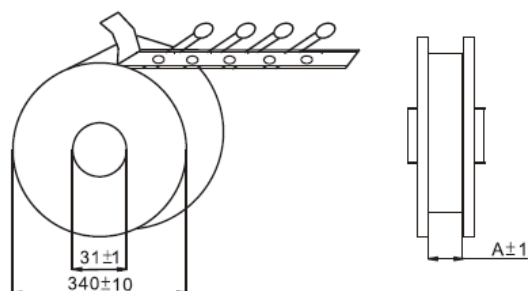

(Unit: mm)

# Metal Oxide Varistor : TVR Series



## Disc Type Varistor for Surge Protection

### ● Ammo Packing

| Series         | Quantity<br>(pcs/box)<br>P0=12.7mm | Quantity<br>(pcs/box)<br>P0=15.0mm |
|----------------|------------------------------------|------------------------------------|
| TVR05(180~391) | 1,500                              | 1,500                              |
| TVR05(431~751) | 1,200                              | 1,000                              |
| TVR07(180~391) | 1,500                              | 1,500                              |
| TVR07(431~511) | 1,200                              | 1,200                              |
| TVR07(561~821) | 1,000                              | 1,200                              |
| TVR10(180~361) | 1,200                              | 950                                |
| TVR10(391~621) | 1,200                              | 750                                |
| TVR10(681~112) | 800                                | 600                                |
| TVR10(122~182) | 700                                | 400                                |
| TVR14(180~271) | 650                                | 500                                |
| TVR14(301~561) | 500                                | 450                                |
| TVR14(621~751) | 400                                | 350                                |
| TVR14(821~112) | 300                                | 300                                |
| TVR14(122~182) | 300                                | 250                                |
| TVR20(180~751) | 300                                | 300                                |
| TVR20(821~182) | 250                                | 250                                |

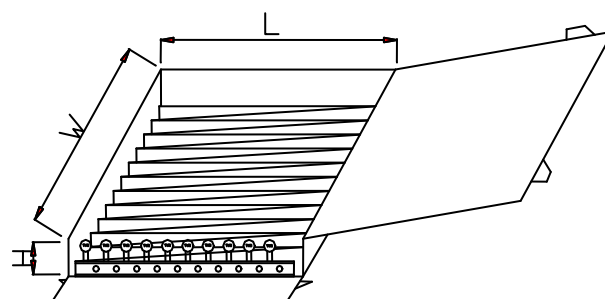

(Unit: mm)

| Series           | W±5 | L±5 | H±5 |
|------------------|-----|-----|-----|
| TVR05<br>~ TVR20 | 345 | 275 | 55  |

### ■ Warehouse Storage Conditions of Products

- Storage Conditions:
  1. Storage Temperature: -10°C~+40°C
  2. Relative Humidity: ≤75%RH
  3. Keep away from corrosive atmosphere and sunlight.
- Period of Storage: 1 year