

SIPMOS® Power Transistor

BUZ 40 B

- N channel
- Enhancement mode
- Avalanche-rated

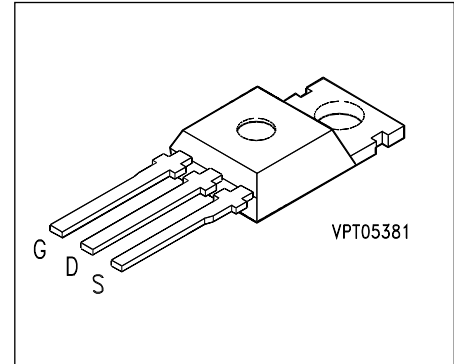

Type	V_{DS}	I_D	$R_{DS(on)}$	Package ¹⁾	Ordering Code
BUZ 40 B	500 V	8.5 A	0.8 Ω	TO-220 AB	C67078-S1305-A4

Maximum Ratings

Parameter	Symbol	Values	Unit
Continuous drain current, $T_C = 35\text{ }^\circ\text{C}$	I_D	8.5	A
Pulsed drain current, $T_C = 25\text{ }^\circ\text{C}$	$I_{D\text{ puls}}$	34	
Avalanche current, limited by $T_{j\text{ max}}$	I_{AR}	10	
Avalanche energy, periodic limited by $T_{j\text{ (max)}}$	E_{AR}	13	mJ
Avalanche energy, single pulse $I_D = 10\text{ A}$, $V_{DD} = 50\text{ V}$, $R_{GS} = 25\text{ }\Omega$ $L = 10.3\text{ mH}$, $T_j = 25\text{ }^\circ\text{C}$	E_{AS}	570	
Gate-source voltage	V_{GS}	± 20	V
Power dissipation, $T_C = 25\text{ }^\circ\text{C}$	P_{tot}	75	W
Operating and storage temperature range	T_j, T_{stg}	- 55 ... + 150	$^\circ\text{C}$
Thermal resistance, chip-case	$R_{th\text{ JC}}$	≤ 0.83	K/W
DIN humidity category, DIN 40 040		E	–
IEC climatic category, DIN IEC 68-1		55/150/56	

1) See chapter Package Outlines.

Electrical Characteristics

at $T_j = 25\text{ °C}$, unless otherwise specified.

Parameter	Symbol	Values			Unit
		min.	typ.	max.	

Static characteristics

Drain-source breakdown voltage $V_{GS} = 0\text{ V}, I_D = 0.25\text{ mA}$	$V_{(BR) DSS}$	500	–	–	V
Gate threshold voltage $V_{GS} = V_{DS}, I_D = 1\text{ mA}$	$V_{GS(th)}$	2.1	3.0	4.0	
Zero gate voltage drain current $V_{DS} = 500\text{ V}, V_{GS} = 0\text{ V}$ $T_j = 25\text{ °C}$ $T_j = 125\text{ °C}$	I_{DSS}	–	0.1 10	1.0 100	μA
Gate-source leakage current $V_{GS} = 20\text{ V}, V_{DS} = 0\text{ V}$	I_{GSS}	–	10	100	nA
Drain-source on-resistance $V_{GS} = 10\text{ V}, I_D = 5.5\text{ A}$	$R_{DS(on)}$	–	0.6	0.8	W

Dynamic characteristics

Forward transconductance $V_{DS} \geq 2 \times I_D \times R_{DS(on)max}, I_D = 5.5\text{ A}$	g_{fs}	5.0	8.0	–	S
Input capacitance $V_{GS} = 0\text{ V}, V_{DS} = 25\text{ V}, f = 1\text{ MHz}$	C_{iss}	–	1500	2300	μF
Output capacitance $V_{GS} = 0\text{ V}, V_{DS} = 25\text{ V}, f = 1\text{ MHz}$	C_{oss}	–	180	270	
Reverse transfer capacitance $V_{GS} = 0\text{ V}, V_{DS} = 25\text{ V}, f = 1\text{ MHz}$	C_{rss}	–	65	100	
Turn-on time t_{on} , ($t_{on} = t_{d(on)} + t_r$) $V_{DD} = 30\text{ V}, V_{GS} = 10\text{ V}, I_D = 3\text{ A}, R_{GS} = 50\ \Omega$	$t_{d(on)}$	–	20	30	ns
	t_r	–	70	110	
Turn-off time t_{off} , ($t_{off} = t_{d(off)} + t_f$) $V_{DD} = 30\text{ V}, V_{GS} = 10\text{ V}, I_D = 3\text{ A}, R_{GS} = 50\ \Omega$	$t_{d(off)}$	–	260	340	
	t_f	–	80	100	

Electrical Characteristics (cont'd)

at $T_j = 25\text{ °C}$, unless otherwise specified.

Parameter	Symbol	Values			Unit
		min.	typ.	max.	

Reverse diode

Continuous reverse drain current $T_C = 25\text{ °C}$	I_S	–	–	8.5	A
Pulsed reverse drain current $T_C = 25\text{ °C}$	I_{SM}	–	–	34	
Diode forward on-voltage $I_S = 20\text{ A}$, $V_{GS} = 0\text{ V}$	V_{SD}	–	1.1	1.3	V
Reverse recovery time $V_R = 100\text{ V}$, $I_F = I_S$, $di_F / dt = 100\text{ A}/\mu\text{s}$	t_{rr}	–	380	–	ns
Reverse recovery charge $V_R = 100\text{ V}$, $I_F = I_S$, $di_F / dt = 100\text{ A}/\mu\text{s}$	Q_{rr}	–	4	–	μC

Characteristics at $T_j = 25\text{ }^\circ\text{C}$, unless otherwise specified.

Total power dissipation

$P_{\text{tot}} = f(T_C)$

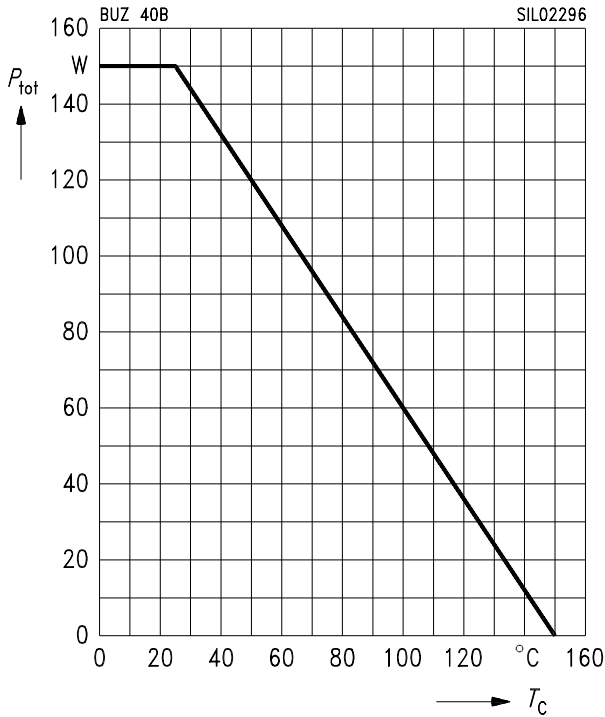

Typ. output characteristics

$I_D = f(V_{\text{DS}})$

parameter: $t_p = 80\text{ }\mu\text{s}$

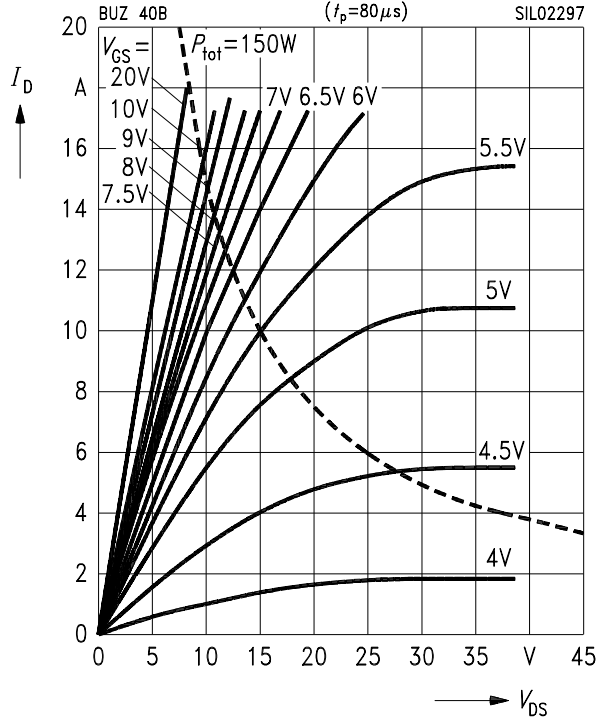

Safe operating area

$I_D = f(V_{\text{DS}})$

parameter: $D = 0.01$, $T_C = 25\text{ }^\circ\text{C}$

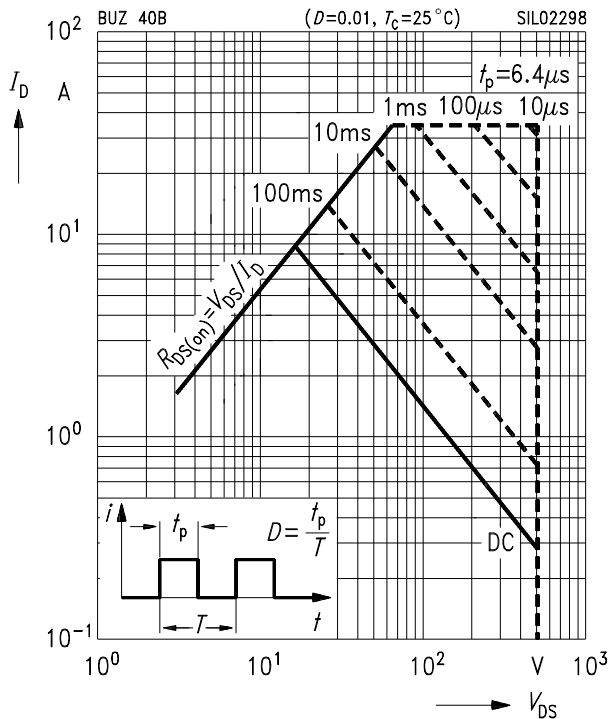

Typ. transfer characteristics

$I_D = f(V_{\text{GS}})$

parameter: $t_p = 80\text{ }\mu\text{s}$, $V_{\text{DS}} = 25\text{ V}$

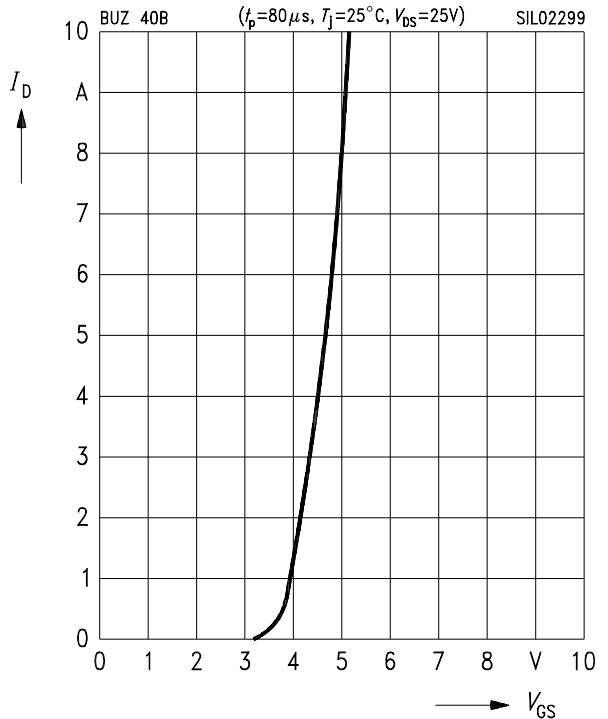

Typ. drain-source on-resistance

$$R_{DS(on)} = f(I_D)$$

parameter: V_{GS}

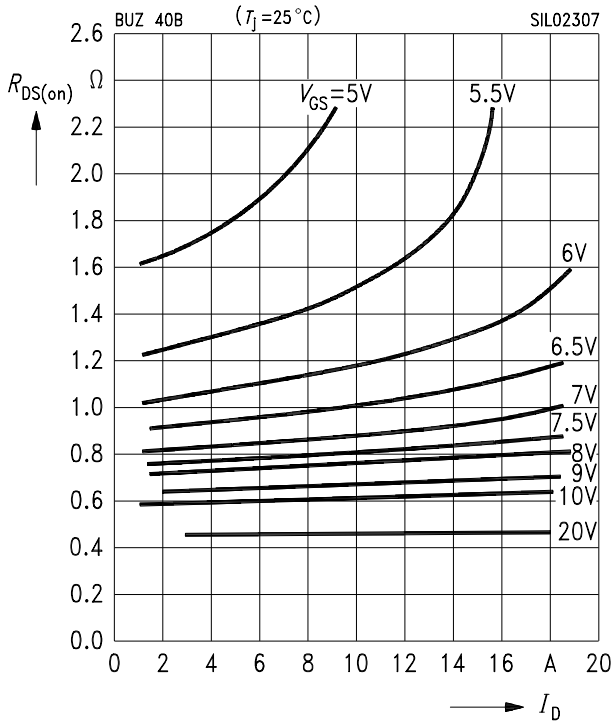

Drain-source on-resistance

$$R_{DS(on)} = f(T_j)$$

parameter: $I_D = 5.5\text{ A}$, $V_{GS} = 10\text{ V}$, (spread)

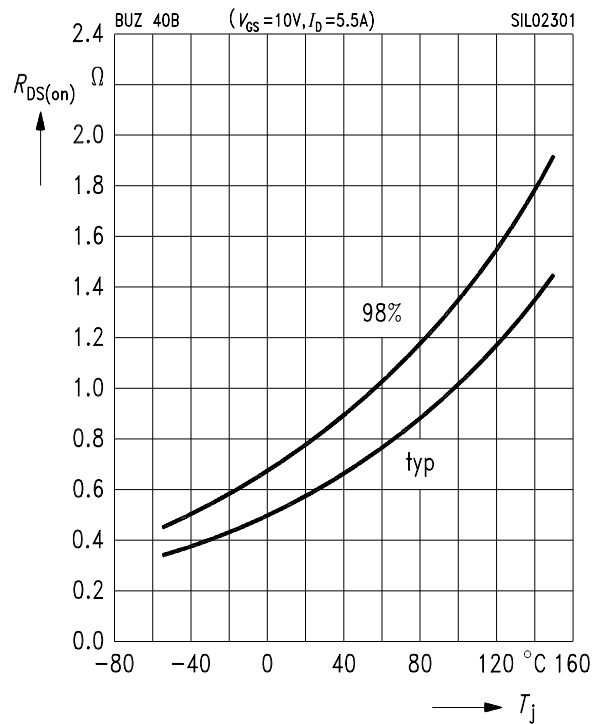

Typ. forward transconductance

$$g_{fs} = f(I_D)$$

parameter: $t_p = 80\ \mu\text{s}$

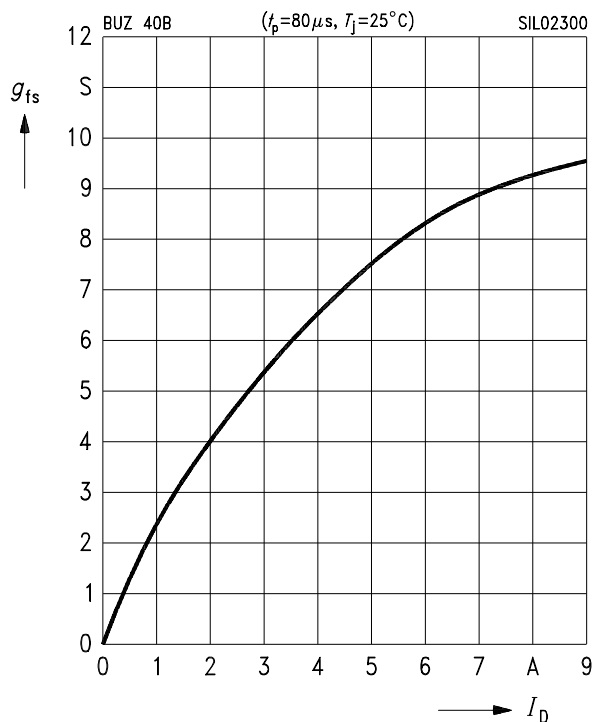

Gate threshold voltage

$$V_{GS(th)} = f(T_j)$$

parameter: $V_{GS} = V_{DS}$, $I_D = 1\text{ mA}$, (spread)

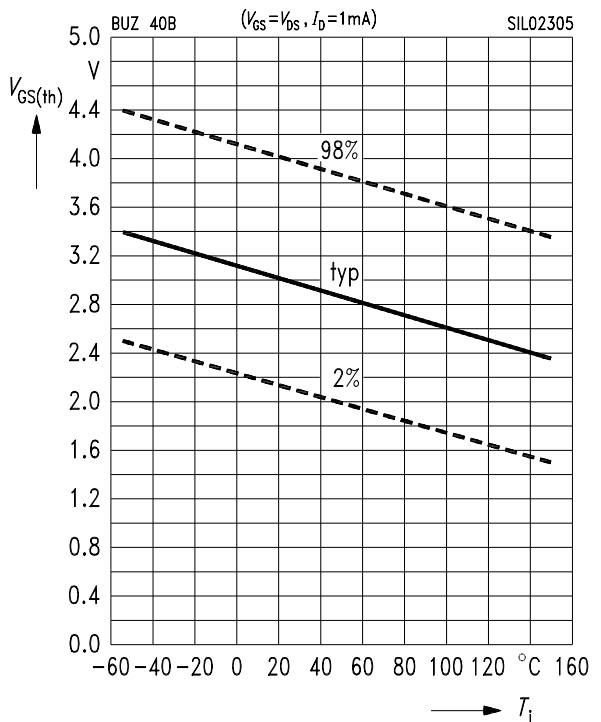

Typ. capacitances

$C = f(V_{DS})$

parameter: $V_{GS} = 0\text{ V}$, $f = 1\text{ MHz}$

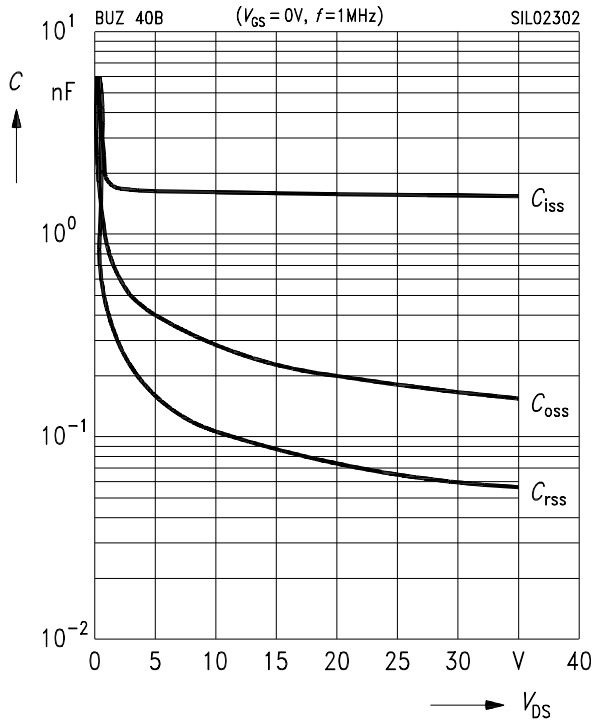

Drain current

$I_D = f(T_C)$

parameter: $V_{GS} \geq 10\text{ V}$

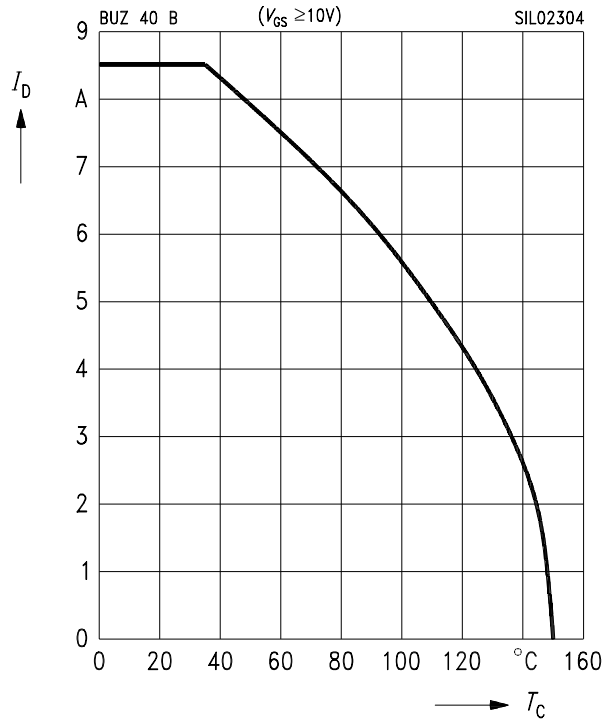

Forward characteristics of reverse diode

$I_F = f(V_{SD})$

parameter: T_j , $t_p = 80\ \mu\text{s}$, (spread)

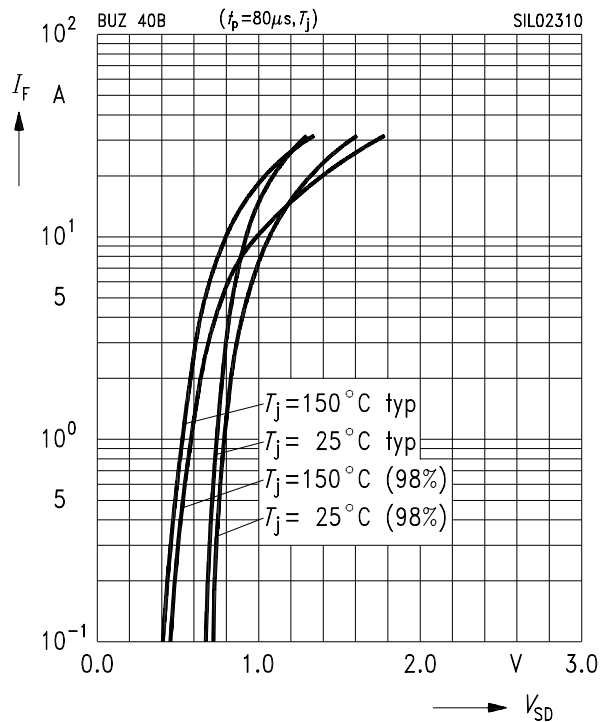

Avalanche energy $E_{AS} = f(T_j)$

parameter: $I_D = 10\text{ A}$, $V_{DD} = 50\text{ V}$

$R_{GS} = 25\ \Omega$, $L = 10.3\text{ mH}$

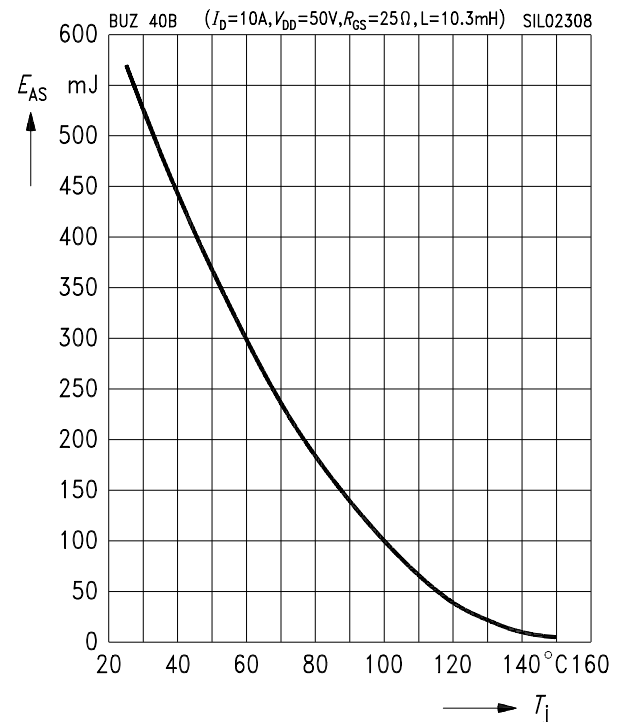

Transient thermal impedance

$$Z_{thJC} = f(t_p)$$

parameter: $D = t_p / T$

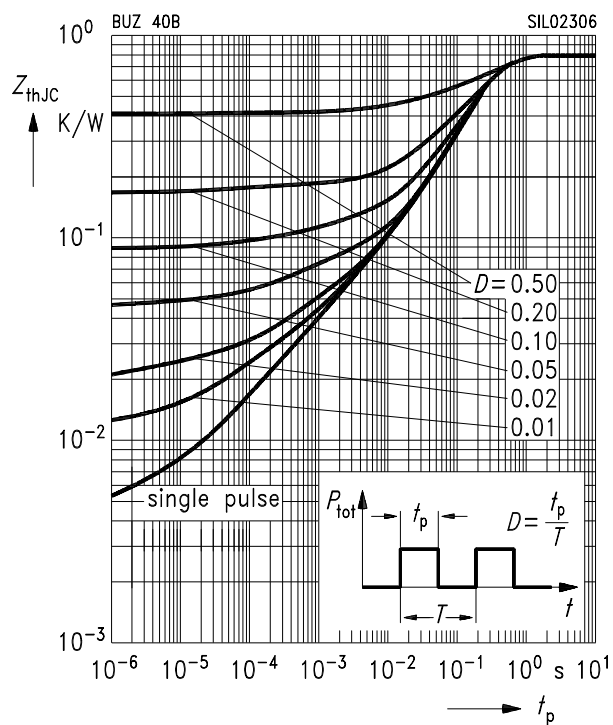

Typ. gate charge

$$V_{GS} = f(Q_{Gate})$$

parameter: $I_{D\ puls} = 12.0\ A$

