

HC-101

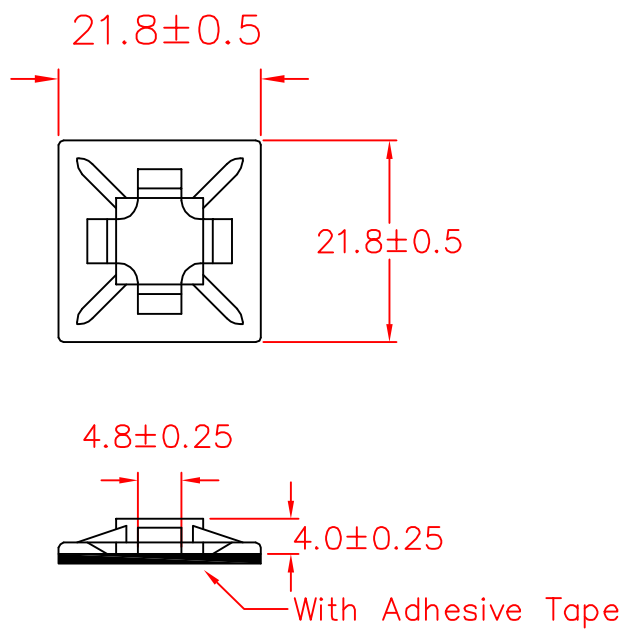

承認
KSS
109.05.04
邱平裕

審查

製圖
KSS
109.05.04
謝文通

設計

中文名 黏式配線固定座		MATERIAL UL 94V-2 NYLON 66	ITEM NO. HC-101
SCALE mm		FINISH	NAME SELF ADHESIVE TIE MOUNT
△ ()	TOLERANCE AS FIGURE	△ 05-04-2020 DATE	REVISIONS K002
使用機種			R.NO.

