

0.5mm Pitch

SERIES

# 6240

0.5mmピッチ RA SMT 下接点 ワンタッチロック 小極

0.5mmPitch RA SMT Bottom contact One-touch lock Low-pin count

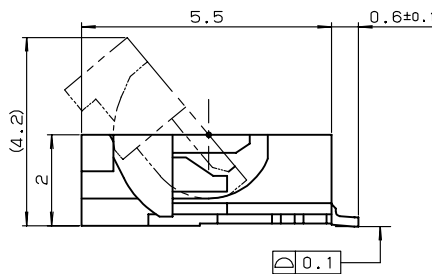
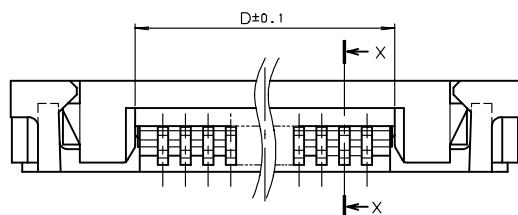
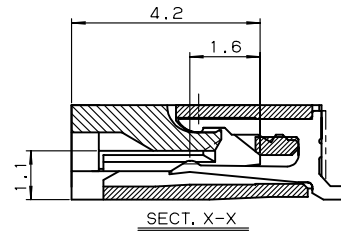
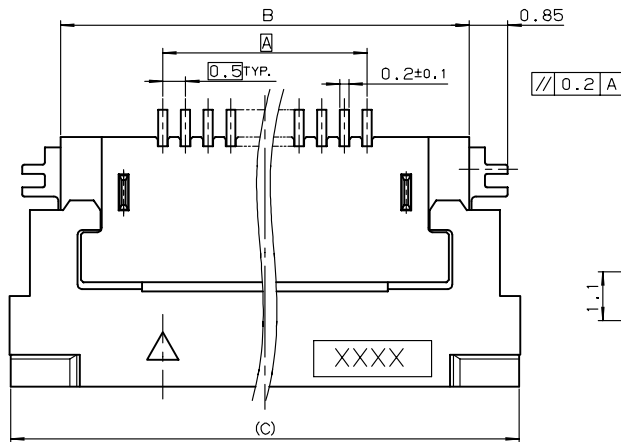

極数 NO. OF POS.	A	B	C	D
5	2.0	6.5	8.7	3.1
6	2.5	7.0	9.2	3.6
7	3.0	7.5	9.7	4.1
8	3.5	8.0	10.2	4.6
9	4.0	8.5	10.7	5.1
10	4.5	9.0	11.2	5.6
11	5.0	9.5	11.7	6.1
12	5.5	10.0	12.2	6.6
13	6.0	10.5	12.7	7.1
14	6.5	11.0	13.2	7.6
15	7.0	11.5	13.7	8.1
16	7.5	12.0	14.2	8.6
17	8.0	12.5	14.7	9.1
18	8.5	13.0	15.2	9.6
19	9.0	13.5	15.7	10.1
20	9.5	14.0	16.2	10.6
21	10.0	14.5	16.7	11.1
22	10.5	15.0	17.2	11.6
23	11.0	15.5	17.7	12.1
24	11.5	16.0	18.2	12.6
25	12.0	16.5	18.7	13.1
26	12.5	17.0	19.2	13.6
27	13.0	17.5	19.7	14.1
28	13.5	18.0	20.2	14.6
29	14.0	18.5	20.7	15.1
30	14.5	19.0	21.2	15.6

生産対応可能極数については、営業部にご確認願います。

Feel free to contact our sales department for available numbers of positions.

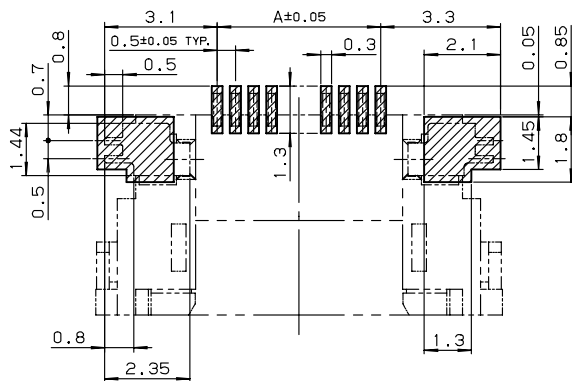

基板取付け寸法  
MOUNTING LAYOUT

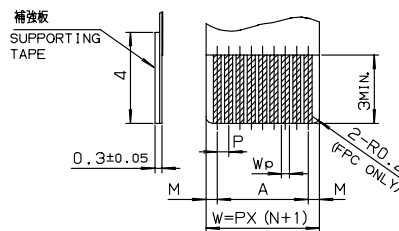

	FPC		FFC	
	1	2	1	2
M	0.5±0.12	0.5±0.1	0.5±0.1	0.5±0.08
P	0.5±0.02	0.5±0.05	0.5±0.03	0.5±0.05
A	A±0.03	A±0.05	A±0.03	A±0.05
W	W±0.07	W±0.07	W±0.07	W±0.07
Wp	0.35 <sup>+0.04</sup> <sub>-0.03</sub>	0.35±0.05	0.3 <sup>+0.05</sup> <sub>-0.02</sub>	0.3 <sup>+0.05</sup> <sub>-0.02</sub>

適用FPC, FFC寸法  
APPLICABLE FPC, FFC

注文コード ORDERING CODE

04 6240 OXX 0X6 XXX X

006 800+ : スズ銅めっき Sn-Cu Plated (RoHS対応品 RoHS Compliant Product)

006 800 : スズ鉛めっき Sn-Pb Plated

026 846+ : 金めっき Au Plated (RoHS対応品 RoHS Compliant Product)

極数 NUMBER OF POSITIONS

0.5mm Pitch

SERIES

# 6240

0.5mmピッチ RA SMT 下接点 ワンタッチロック 中極

0.5mmPitch RA SMT Bottom contact One-touch lock Medium-pin count

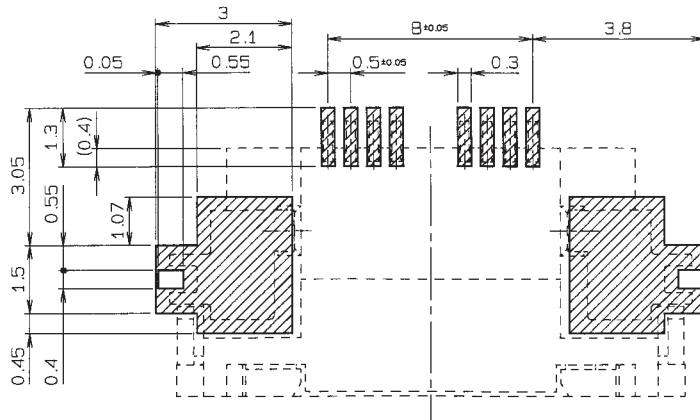
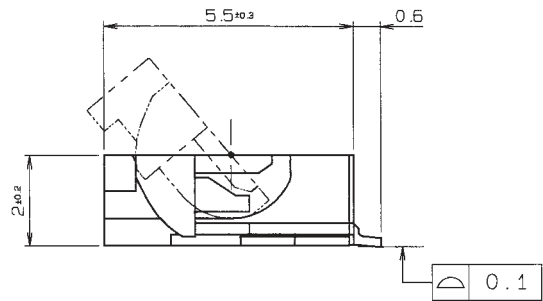
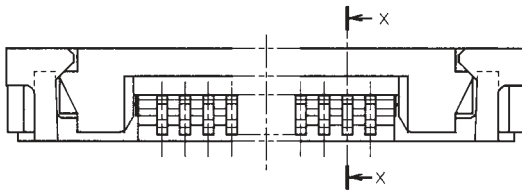
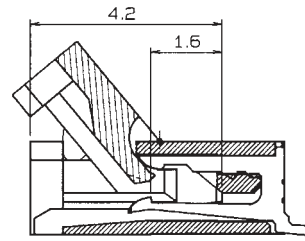
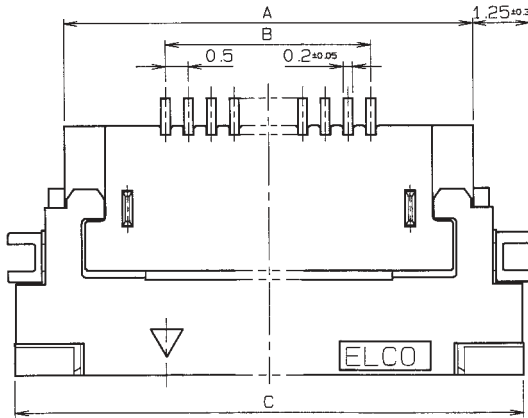

	FPC		FFC	
	1	2	1	2
M	0.5 <sup>±0.12</sup>	0.5 <sup>±0.1</sup>	0.5 <sup>±0.1</sup>	0.5 <sup>±0.08</sup>
P	0.5 <sup>±0.02</sup>	0.5 <sup>±0.05</sup>	0.5 <sup>±0.03</sup>	0.5 <sup>±0.05</sup>
B	B <sup>±0.03</sup>	B <sup>±0.05</sup>	B <sup>±0.03</sup>	B <sup>±0.05</sup>
W	W <sup>±0.07</sup>	W <sup>±0.07</sup>	W <sup>±0.07</sup>	W <sup>±0.07</sup>
WD	0.35 <sup>±0.04</sup>	0.35 <sup>±0.05</sup>	0.3 <sup>±0.02</sup>	0.3 <sup>±0.02</sup>

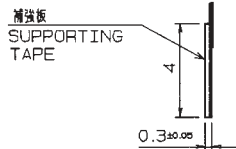

極数 NO. OF POS.	A	B	C
30	19.0	14.5	21.2
31	19.5	15.0	21.7
32	20.0	15.5	22.2
33	20.5	16.0	22.7
34	21.0	16.5	23.2
35	21.5	17.0	23.7
36	22.0	17.5	24.2
37	22.5	18.0	24.7
38	23.0	18.5	25.2
39	23.5	19.0	25.7
40	24.0	19.5	26.2
41	24.5	20.0	26.7
42	25.0	20.5	27.2
43	25.5	21.0	27.7
44	26.0	21.5	28.2
45	26.5	22.0	28.7
46	27.0	22.5	29.2
47	27.5	23.0	29.7
48	28.0	23.5	30.2
49	28.5	24.0	30.7
50	29.0	24.5	31.2

適用FPC, FFC寸法

APPLICABLE FPC, FFC

注文コード ORDERING CODE

04 6240 0XX 0X1 XXX X

- 001 800+ : スズ銅めっき Sn-Cu Plated (RoHS対応品 RoHS Compliant Product)
- 001 800 : スズ鉛めっき Sn-Pb Plated
- 021 846+ : 金めっき Au Plated (RoHS対応品 RoHS Compliant Product)

極数 NUMBER OF POSITIONS

生産対応可能極数については、営業部にご確認願います。  
Feel free to contact our sales department for available numbers of positions.

0.5mm Pitch

SERIES

# 6240

0.5mmピッチ RA SMT 下接点 ワンタッチロック 大極

0.5mmPitch RA SMT Bottom contact One-touch lock High-pin count

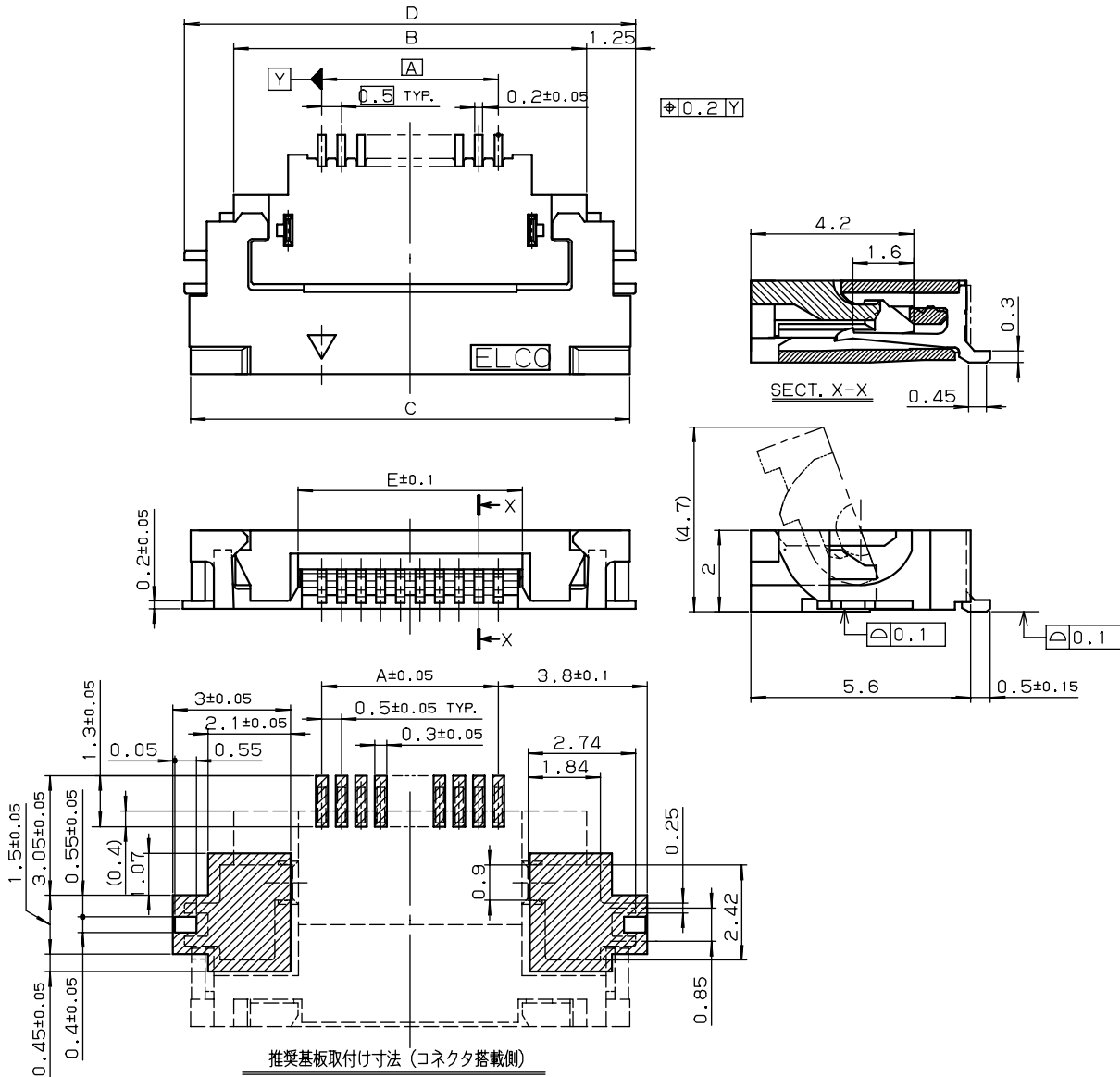

MOUNTING LAYOUT (CONN. MOUNTING SIDE)

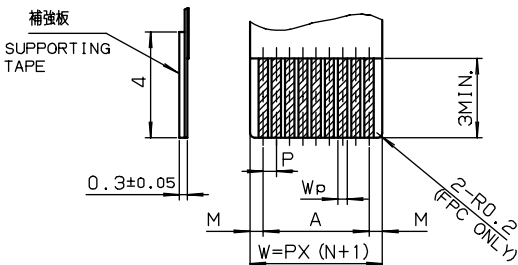

	FPC		FFC	
	1	2	1	2
M	0.5±0.12	0.5±0.1	0.5±0.1	0.5±0.08
P	0.5±0.02	0.5±0.05	0.5±0.03	0.5±0.05
A	A±0.03	A±0.05	A±0.03	A±0.05
W	W±0.07	W±0.07	W±0.07	W±0.07
Wp	0.35 <sup>+0.04</sup> <sub>-0.03</sub>	0.35±0.05	0.3 <sup>+0.05</sup> <sub>-0.02</sub>	0.3 <sup>+0.05</sup> <sub>-0.02</sub>

適用FPC, FFC寸法  
APPLICABLE FPC, FFC

極数 NO. OF POS.	寸法 DIMENSION				
	A	B	C	D	E
51	25.0	29.5	31.7	32.0	26.17
52	25.5	30.0	32.2	32.5	26.67
53	26.0	30.5	32.7	33.0	27.17
54	26.5	31.0	33.2	33.5	27.67
55	27.0	31.5	33.7	34.0	28.17
56	27.5	32.0	34.2	34.5	28.67
57	28.0	32.5	34.7	35.0	29.17
58	28.5	33.0	35.2	35.5	29.67
59	29.0	33.5	35.7	36.0	30.17
60	29.5	34.0	36.2	36.5	30.67

注文コード ORDERING CODE  
04 6240 0XX 0X5 XXX X

- 005 800+: スズ銅めっき Sn-Cu Plated (RoHS対応品 RoHS Compliant Product)
- 005 800: スズ鉛めっき Sn-Pb Plated
- 025 846+: 金めっき Au Plated (RoHS対応品 RoHS Compliant Product)

極数 NUMBER OF POSITIONS

生産対応可能極数については、営業部にご確認  
願います。  
Feel free to contact our sales department for available numbers of positions.

0.5mm Pitch

SERIES

# 6240

エンボス梱包品  
Tape and Reel Package

## ●5~50 POSITIONS

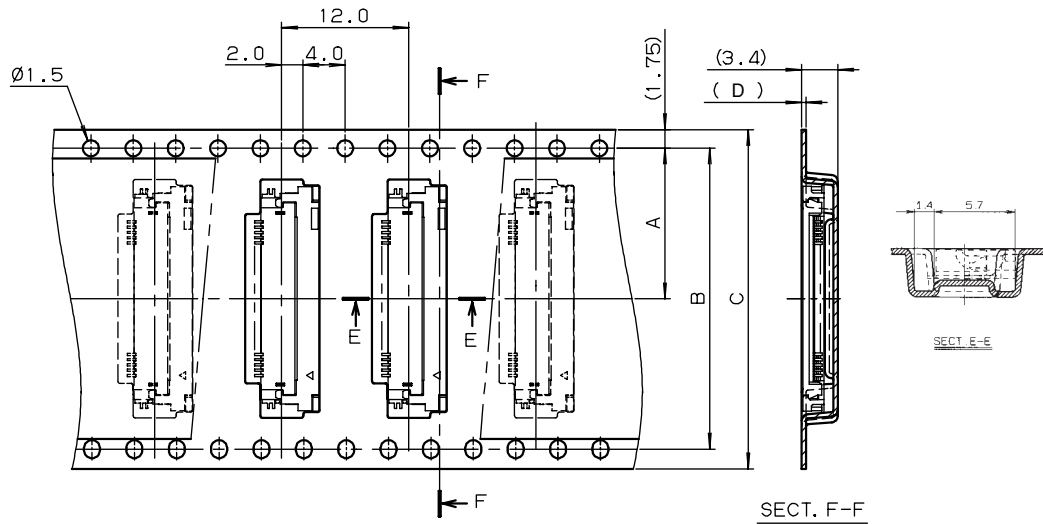

極数 NO. OF POS.	A	B	C	D
5	11.5	—	24	0.4
6	11.5	—	24	0.4
7	11.5	—	24	0.4
8	11.5	—	24	0.4
9	11.5	—	24	0.4
10	11.5	—	24	0.4
11	11.5	—	24	0.4
12	11.5	—	24	0.4
13	11.5	—	24	0.4
14	11.5	—	24	0.4
15	11.5	—	24	0.4
16	11.5	—	24	0.4
17	11.5	—	24	0.4
18	11.5	—	24	0.4
19	11.5	—	24	0.4
20	14.2	26.4	32	0.4
21	14.2	26.4	32	0.4
22	14.2	26.4	32	0.4
23	14.2	26.4	32	0.4
24	14.2	26.4	32	0.4
25	14.2	26.4	32	0.4
26	14.2	26.4	32	0.4
27	14.2	26.4	32	0.4
28	14.2	26.4	32	0.4
29	14.2	26.4	32	0.4
30	14.2	26.4	32	0.4

注文コード ORDERING CODE  
**04 6240 0XX 0X6 XXX X**

- 006 800+ : スズ銅めっき Sn-Cu Plated (RoHS対応品 RoHS Compliant Product)
- 006 800 : スズ鉛めっき Sn-Pb Plated
- 026 846+ : 金めっき Au Plated (RoHS対応品 RoHS Compliant Product)

極数 NUMBER OF POSITIONS

注文コード ORDERING CODE  
**04 6240 0XX 0X1 XXX X**

- 001 800+ : スズ銅めっき Sn-Cu Plated (RoHS対応品 RoHS Compliant Product)
- 001 800 : スズ鉛めっき Sn-Pb Plated
- 021 846+ : 金めっき Au Plated (RoHS対応品 RoHS Compliant Product)

極数 NUMBER OF POSITIONS

極数 NO. OF POS.	A	B	C	D
31	20.2	40.4	44	0.3
32	20.2	40.4	44	0.3
33	20.2	40.4	44	0.3
34	20.2	40.4	44	0.3
35	20.2	40.4	44	0.3
36	20.2	40.4	44	0.3
37	20.2	40.4	44	0.3
38	20.2	40.4	44	0.3
39	20.2	40.4	44	0.3
40	20.2	40.4	44	0.3
41	20.2	40.4	44	0.3
42	20.2	40.4	44	0.3
43	20.2	40.4	44	0.3
44	20.2	40.4	44	0.3
45	20.2	40.4	44	0.3
46	20.2	40.4	44	0.3
47	20.2	40.4	44	0.3
48	20.2	40.4	44	0.3
49	20.2	40.4	44	0.3
50	20.2	40.4	44	0.3

## ●51~60 POSITIONS

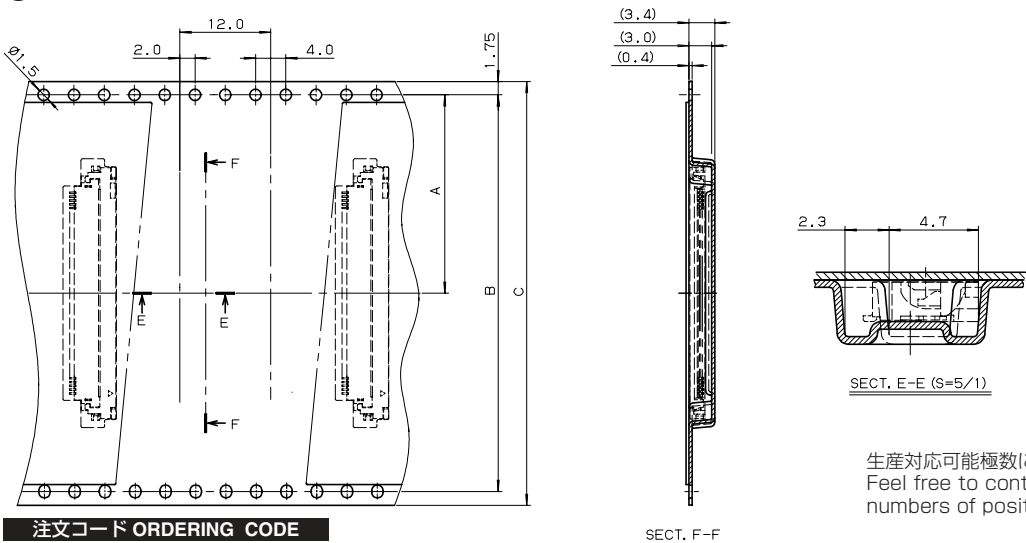

極数 NO. OF POS.	A	B	C
51	26.5	52.4	56.0
52	26.5	52.4	56.0
53	26.5	52.4	56.0
54	26.5	52.4	56.0
55	26.5	52.4	56.0
56	26.5	52.4	56.0
57	26.5	52.4	56.0
58	26.5	52.4	56.0
59	26.5	52.4	56.0
60	26.5	52.4	56.0

注文コード ORDERING CODE  
**04 6240 0XX 0X5 XXX X**

- 005 800+ : スズ銅めっき Sn-Cu Plated (RoHS対応品 RoHS Compliant Product)
- 005 800 : スズ鉛めっき Sn-Pb Plated
- 025 846+ : 金めっき Au Plated (RoHS対応品 RoHS Compliant Product)

極数 NUMBER OF POSITIONS

生産対応可能極数については、営業部にご確認願います。  
Feel free to contact our sales department for available numbers of positions.

梱包数量 2000個/リール  
PACKING QUANTITY : 2000/Reel