



## ■ Features

- Universal AC input / Full range
- Compact size
- Protections: Short circuit / Overload / Over voltage
- Cooling by free air convection
- Isolation Class II
- No load power consumption < 0.1W
- Pass LPS
- 100% full load burn-in test
- High reliability
- 3 years warranty

## ■ Applications

- Industrial electrical equipment
- Mechanical equipment
- Factory automation equipment
- Hand-held electronic device

## ■ Description

IRM-30 is a 30W miniature (69.5\*39\*24mm) AC-DC module-type power supply, ready to be soldered onto the PCB boards of various kinds of electronic instruments or industrial automation equipments. This product allows the universal input voltage range of 85~264VAC. The 94V-0 flame retardant plastic case and the fully-potted silicone enhance the heat dissipation and meet the anti-vibration demand up to 5G; moreover, it provides the fundamental resistance to dust and moisture.

With the high efficiency up to 90% and the extremely low no-load power consumption below 0.1W, IRM-30 series fulfills the worldwide regulation for the low power consumption requirement for electronics. The entire series is a Class II design (no FG pin), incorporating the built-in EMI filtering components, enabling the compliance with EN55022 Class B; the supreme EMC features keep the end electronic units from electromagnetic interference. In addition to module-type model, IRM-30 series also offers the screw terminal style model (ST).

## ■ Model Encoding

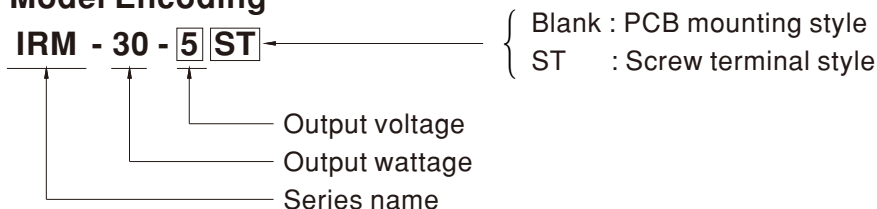



## SPECIFICATION

MODEL	IRM-30-5	IRM-30-12	IRM-30-15	IRM-30-24	IRM-30-48	
OUTPUT	DC VOLTAGE	5V	12V	15V	24V	48V
	RATED CURRENT	6A	2.5A	2A	1.3A	0.63A
	CURRENT RANGE	0 ~ 6A	0 ~ 2.5A	0 ~ 2A	0 ~ 1.3A	0 ~ 0.63A
	RATED POWER	30W	30W	30W	31.2W	30.2W
	RIPPLE & NOISE (max.) Note.2	120mVp-p	150mVp-p	200mVp-p	240mVp-p	300mVp-p
	VOLTAGE TOLERANCE Note.3	±2.5%	±2.5%	±2.5%	±2.5%	±2.5%
	LINE REGULATION	±0.5%	±0.5%	±0.5%	±0.5%	±0.5%
	LOAD REGULATION	±1.0%	±0.5%	±0.5%	±0.5%	±0.5%
	SETUP, RISE TIME	1000ms, 30ms/230VAC    1500ms, 30ms/115VAC at full load				
	HOLD UP TIME (Typ.)	40ms/230VAC    12ms/115VAC at full load				
INPUT	VOLTAGE RANGE	85 ~ 264VAC				
	FREQUENCY RANGE	47 ~ 440Hz				
	EFFICIENCY (Typ.)	83%	88%	88%	88.5%	90%
	AC CURRENT (Typ.)	0.75A/115VAC    0.5A/230VAC				
	INRUSH CURRENT (Typ.)	COLD START 25A/115VAC    45A/230VAC				
	LEAKAGE CURRENT	< 0.25mA/240VAC				
PROTECTION	OVERLOAD	105% ~ 160% rated output power Protection type : Hiccup mode, recovers automatically after fault condition is removed				
	OVER VOLTAGE	5.25 ~ 6.75V	12.6 ~ 16.2V	15.75 ~ 20.25V	25.2 ~ 32.4V	50.4 ~ 64V
		Protection type : Shut off o/p voltage, clamping by zener diode				
ENVIRONMENT	WORKING TEMP.	-30 ~ +70°C (Refer to "Derating Curve")				
	WORKING HUMIDITY	20 ~ 90% RH non-condensing				
	STORAGE TEMP., HUMIDITY	-40 ~ +85°C, 10 ~ 95% RH				
	TEMP. COEFFICIENT	±0.03%/°C (0 ~ 50°C)				
	VIBRATION	10 ~ 500Hz, 5G 10min./1cycle, period for 60min. each along X, Y, Z axes				
SAFETY & EMC	SAFETY STANDARDS	UL60950-1, TUV EN60950-1 approved				
	WITHSTAND VOLTAGE	I/P-O/P:3KVAC				
	ISOLATION RESISTANCE	I/P-O/P:100M Ohms / 500VDC / 25°C / 70% RH				
	EMC EMISSION	Compliance to EN55022 (CISPR22) Class B, EN61000-3-2,-3				
	EMC IMMUNITY	Compliance to EN61000-4-2,3,4,5,6,8,11, EN55024, heavy industry level (surge L-N : 1KV), criteria A				
OTHERS	MTBF	593.3Khrs min.    MIL-HDBK-217F (25°C)				
	DIMENSION	PCB mounting style : 69.5*39*24mm (L*W*H)    Screw terminal style : 91*39.5*28.5mm (L*W*H)				
	PACKING	PCB mounting style : 0.109Kg;144pcs/16.7Kg/0.97CUFT    Screw terminal style : 0.12Kg;120pcs/15.4Kg/0.74CUFT				
NOTE	<ol style="list-style-type: none"><li>All parameters NOT specially mentioned are measured at 230VAC input, rated load and 25°C of ambient temperature.</li><li>Ripple &amp; noise are measured at 20MHz of bandwidth by using a 12" twisted pair-wire terminated with a 0.1uf &amp; 47uf parallel capacitor.</li><li>Tolerance : includes set up tolerance, line regulation and load regulation.</li><li>The power supply is considered a component which will be installed into a final equipment. The final equipment must be re-confirmed that it still meets EMC directives.</li></ol>					

■ Block Diagram

fosc : 65KHz

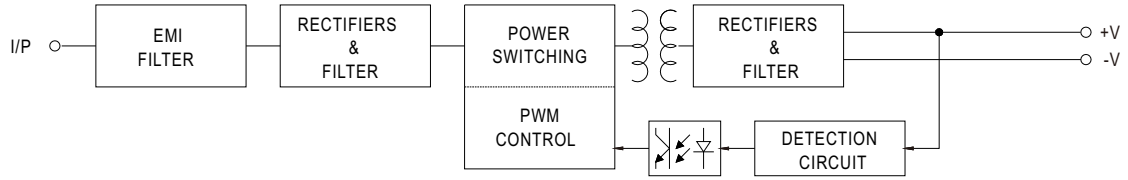

■ Derating Curve

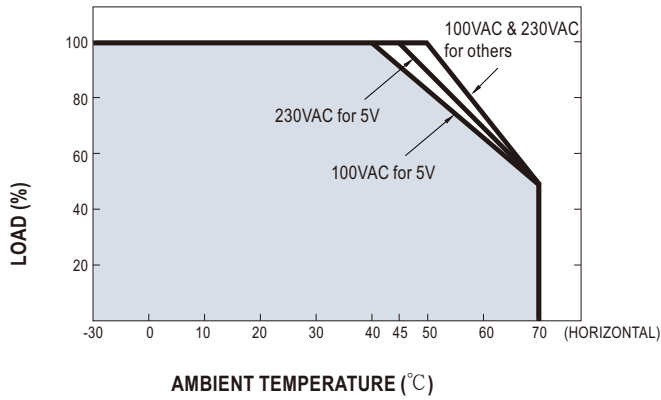

■ Output Derating VS Input Voltage

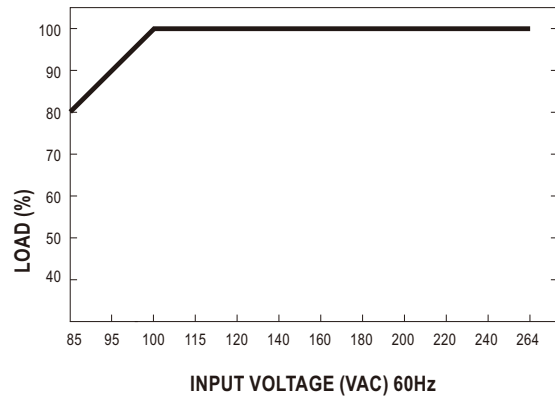

■ Mechanical Specification

Case No. Unit:mm

• PCB mounting style

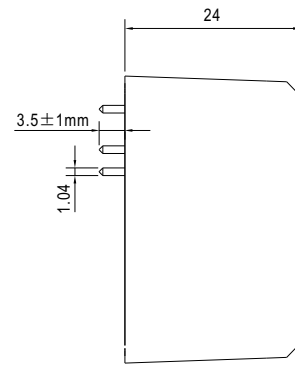
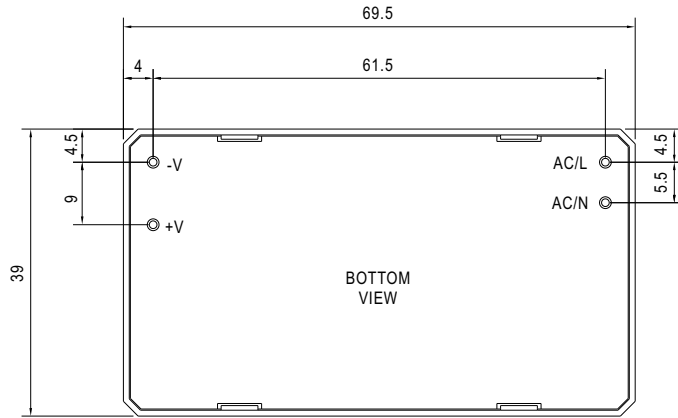

P/N diameter:1.04

• Screw terminal style

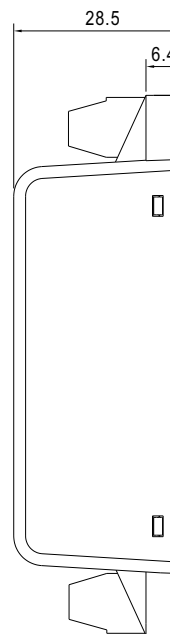
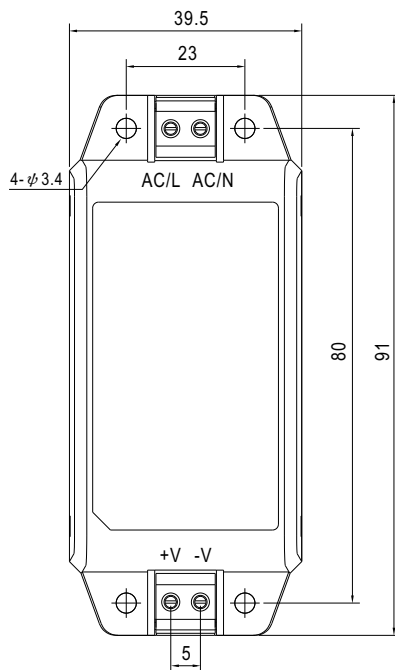

■ Installation Manual

Please refer to : <http://www.meanwell.com/manual.html>