



## LMW78\_0.5 Series

Wide Input Non-Isolated & Regulated, Single Output

### Switching Regulator

- ⊕ Efficiency up to 95%
- ⊕ Ultra wide input voltage range can up to 8:1
- ⊕ Operating temperature: -40°C ~ +85°C
- ⊕ Pin-out compatible with LM78XX Linear
- ⊕ Short circuit protection (SCP), thermal shutdown
- ⊕ Low ripple and noise
- ⊕ Micro miniature SIP package, meet UL94-V0 requirement
- ⊕ No heatsink required
- ⊕ Industry standard pinout
- ⊕ MTBF>2,000,000Hours

The LMW78\_0.5 series high efficiency switching regulators are ideally suited to replace LM78xx linear regulators and are pin compatible. It has ultra wide input voltage range, the efficiency of up to 95% means that very little energy is wasted as heat so there is no need for any heatsinks with their additional space and mounting costs.



RoHS



#### Model selection:

LMW78\_yy-pp

LM=Series; W=case; ##=Vout; pp=output current

Example:

LMW78\_05-0.5

LM=Series; W=wide input; ##= 5Vout; pp=0.5A

Common specifications	
Temperature rise at full load:	25°C MAX, 15°C TYP
Cooling:	Free air convection
Operating temperature range (power derating above 71°C):	-40°C~+85°C
Storage temperature range:	-55°C ~+125°C
Lead temperature:	300°C MAX, 1.5mm from case for 10 sec
Operating case temperature:	100°C MAX, 65°C TYP
Storage humidity range:	< 95%
Case material:	Plastic [UL94-V0]
MTBF:	>3,500,000 hours: 25°C, MIL-HDBK-217F >1,500,000 hours: 71°C, MIL-HDBK-217F
Hop swap:	Not supported
Thermal resistance:	60 °C/W
EMI conducted (Refer to figure 7):	EN55022, CLASS B
RFI conducted:	EN55022, CLASS B
Electrostatic discharge:	IEC/EN 61000-4-2 level 4
Safety approvals:	EN-60950-1 standards
Weight:	4g

Output specifications					
Item	Test conditions	Min	Typ	Max	Units
Output voltage accuracy	100% load		±2	±3	%
Line regulation	Vin= min. to max. at full load		±0.4	±1.0	%
Load regulation	From 10% to 100% load		±0.3	±0.6	%
Ripple + Noise	20MHz bandwidth, from 10% to 100% Load (refer to figure 2)		20	60	mVp-p
Short circuit input power	Vin=Nominal		0.72	1.2	W
Short circuit protection	Continuous, automatic recovery				
Switching frequency	100% full load	120		800	KHz
Output current limit	Vin=Nominal		700	1200	mA
Quiescent current	Vin=Nominal , Min. Load		1	5	mA
Thermal shutdown			160		°C
Temperature coefficient	-40 °C to +85 °C ambient			±0.015	%/°C
Tendencies load	From 10% to 100% Load		1.0	±100 1.5	mV ms
Max capacitance load				100	µF

#### Note:

1. The load shouldn't be less than 10%, and the output external capacitor should not be too large (recommend <10µF), otherwise ripple will increase dramatically.
2. Operation under 10% load will not damage the converter; However, they may not meet all specification listed
3. All specifications measured at Ta=25°C, humidity<75%, nominal input voltage and rated output load unless otherwise specified.
4. In this datasheet, all the test methods of indications are based on corporate

Note: "GND" Pin can not vacant, or it will damage the module.

Part Number	Input Voltage Range [VDC]	Output Voltage [VDC]	Output Current [mA, Max]	Efficiency [Vin. min]	Efficiency [Vin. max]
LMW78_03-0.5	9.0-72.0	3.3	500	82	75
LMW78_05-0.5	9.0-72.0	5.0	500	87	81
LMW78_6.5-0.5	9.0-72.0	6.5	500	91	84
LMW78_09-0.5	14.0-72.0	9.0	500	92	86
LMW78_12-0.5	17.0-72.0	12.0	500	93	89
LMW78_15-0.5	20.0-72.0	15.0	500	94	90
LMW78_24-0.3	36.0-72.0	24.0	500	95	91

Add suffix "L" for 90° bend pins, for example: LMW78\_05-1.0L.

# LMW78\_0.5 Series

Wide Input Non-Isolated & Regulated, Single Positive/Negative Output

## Typical characteristics

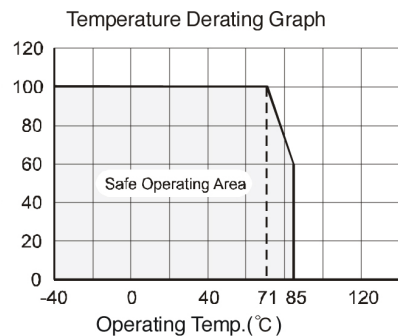
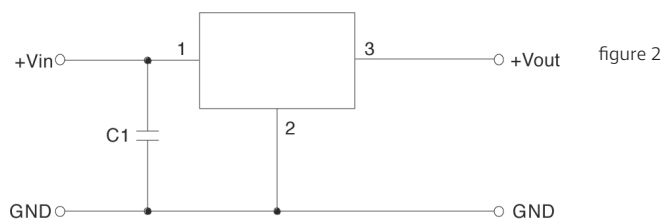

figure 1

## Typical application circuit



- Note:
1. The regulator proposed to establish the input voltage by soft-start, no plug and play, if the input voltage changes from low voltage to high voltage abruptly, the regulator might be damaged.
  2. If the applications is high-voltage input, the regulator must add an external capacitor C1( $\leq 47\mu\text{F}/100\text{V}$ ),to prevent voltage spikes caused by damage to the module.
  3. No parallel connection.

## Application example

High voltage input, multiple outputs, with greater load (figure 3)

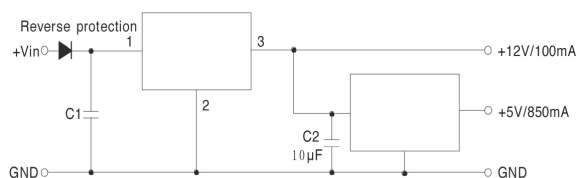

- Note:
1. The input current amount of the back-grade regulator and the pre-class load should be less than or equal the max load current of the pre-class regulator.
  2. If further filtering is required, please add components as per the above circuit (We recommend not to add components), if request, please make sure the capacitors C1  $\leq 47\mu\text{F}$ , C2  $\leq 10\mu\text{F}$  more close to the back-grade regulator.

## Modules protect recommended cir-

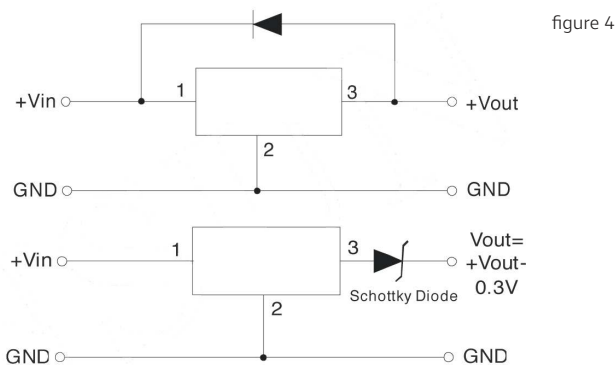

## Test configurations (TA=25°C)

1 Full load output ripple & noise measured graph

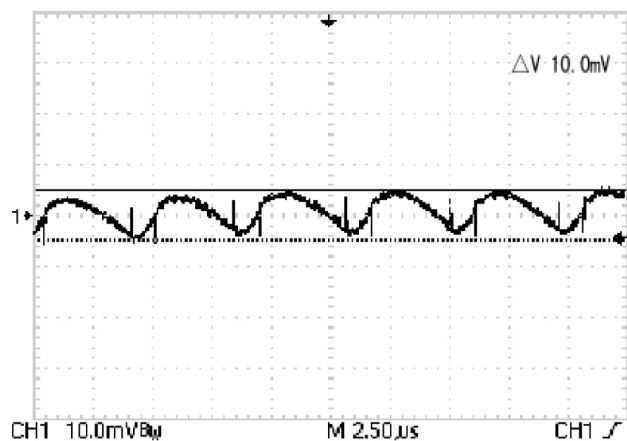

figure 5

2 Load transient response waveform

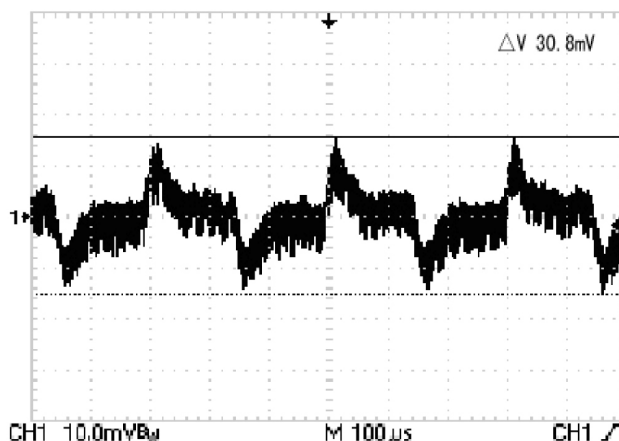

figure 6

# LMW78\_0.5 Series

Wide Input Non-Isolated & Regulated, Single Positive/Negative Output

## EMC recommended circuit

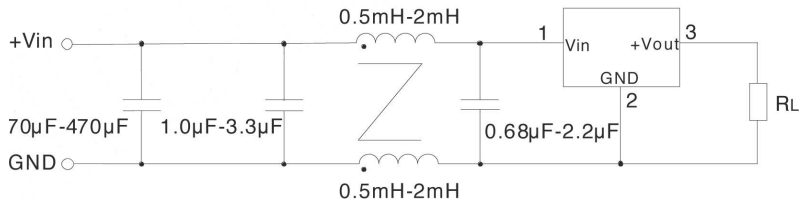
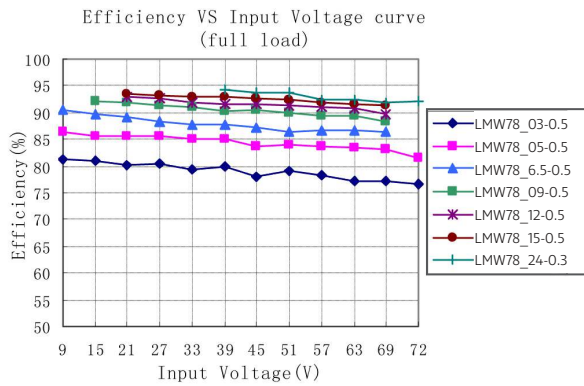

figure 7

## Characteristics curve

### Efficiency



### Ripple

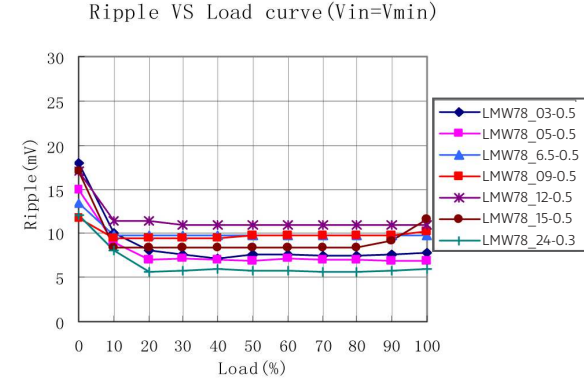
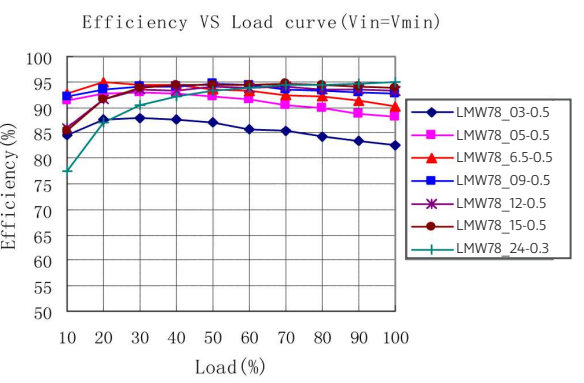
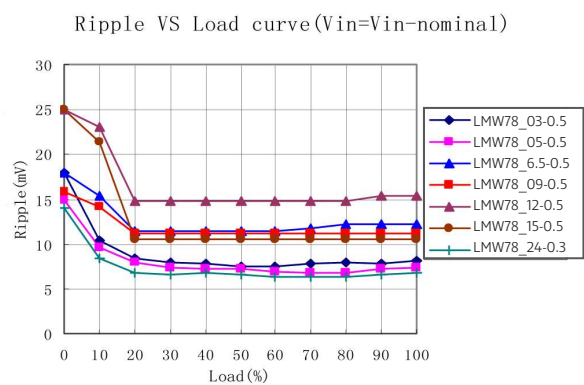
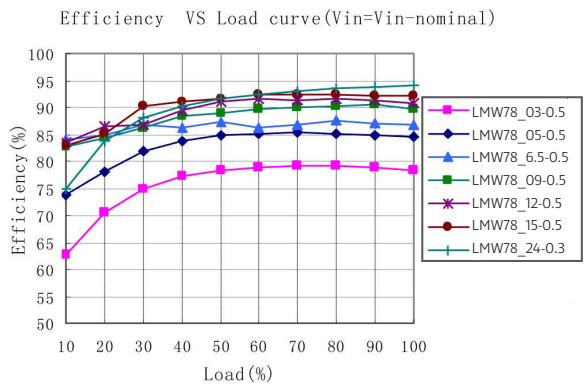
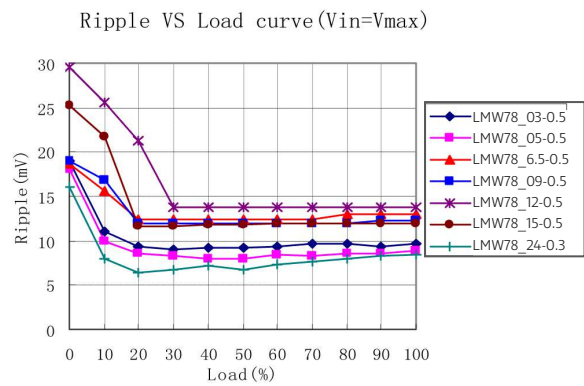

## LMW78\_0.5 Series

Wide Input Non-Isolated & Regulated, Single Positive/Negative Output

### Mechanical dimensions

### Recommended footprint

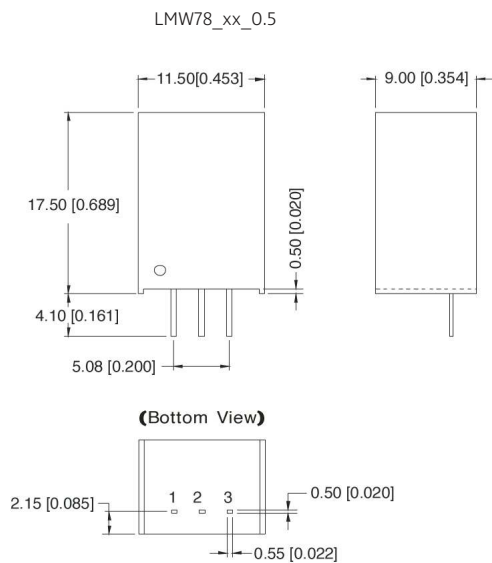

**Note:**

Unit: mm[inch]

Pin selection tolerances:  $\pm 0.10\text{mm}$  [ $\pm 0.004\text{inch}$ ]

General tolerances:  $\pm 0.25\text{mm}$  [ $\pm 0.010\text{inch}$ ]

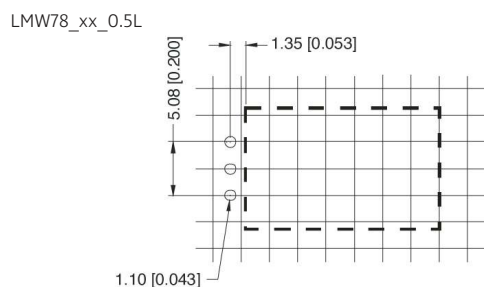
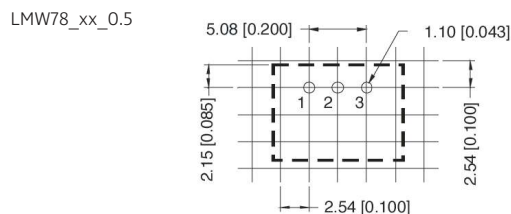

FOOTPRINT DETAILS	
pin	Function
1	+Vin
2	GND
3	+Vout

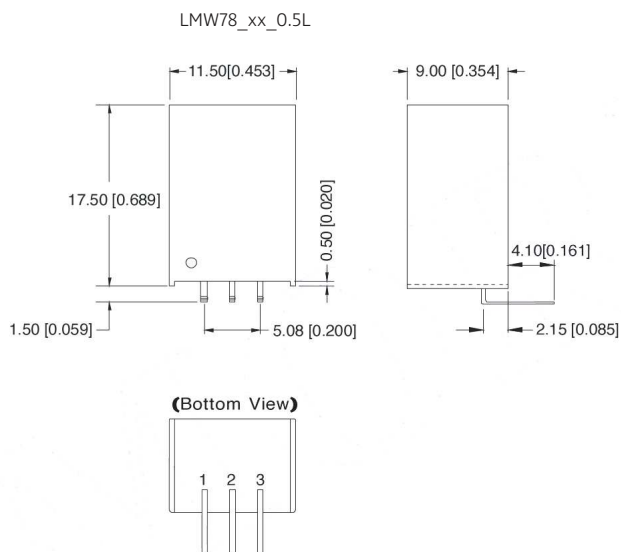

**Note:**

Unit: mm[inch]

Pin selection tolerances:  $\pm 0.10\text{mm}$  [ $\pm 0.004\text{inch}$ ]

General tolerances:  $\pm 0.50\text{mm}$  [ $\pm 0.020\text{inch}$ ]

### Tube outline dimensions

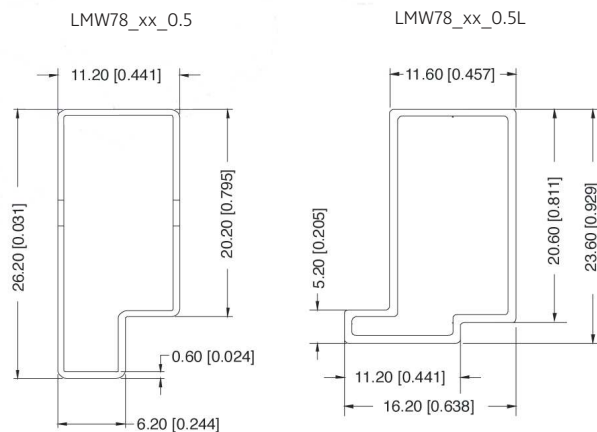

**Note:**

Unit: mm[inch]

General tolerances:  $\pm 0.50\text{mm}$  [ $\pm 0.020\text{inch}$ ]

L=530mm [20.866inch]

Devices per tube quantity: 44pcs

L=220mm [8.661inch]

Devices per tube quantity: 17pcs

Short tube inner packaging dimensions: L\*W\*H=255\*170\*80mm

Short tube outer packaging dimensions: L\*W\*H=375\*280\*270mm

Long tube inner packaging dimensions L\*W\*H=580\*200\*100mm

Long tube outer packaging dimensions (with two inner packaging boxes):

L\*W\*H=600\*215\*220mm

Long tube outer packaging dimensions (with two inner packaging boxes):

L\*W\*H=600\*215\*325mm