

# IRL540NPbF

HEXFET® Power MOSFET

- Lead-Free
- Logic-Level Gate Drive
- Advanced Process Technology
- Dynamic dv/dt Rating
- 175°C Operating Temperature
- Fast Switching
- Fully Avalanche Rated

## Description

Fifth Generation HEXFETs from International Rectifier utilize advanced processing techniques to achieve extremely low on-resistance per silicon area. This benefit, combined with the fast switching speed and ruggedized device design that HEXFET Power MOSFETs are well known for, provides the designer with an extremely efficient and reliable device for use in a wide variety of applications.

The TO-220 package is universally preferred for all commercial-industrial applications at power dissipation levels to approximately 50 watts. The low thermal resistance and low package cost of the TO-220 contribute to its wide acceptance throughout the industry.

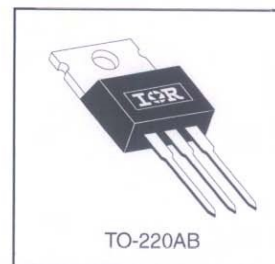
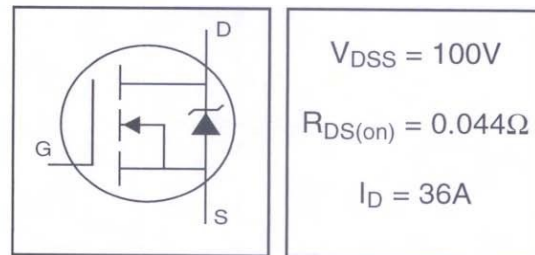

## Absolute Maximum Ratings

	Parameter	Max.	Units
$I_D @ T_C = 25^\circ C$	Continuous Drain Current, $V_{GS} @ 10V$	36	A
$I_D @ T_C = 100^\circ C$	Continuous Drain Current, $V_{GS} @ 10V$	26	
$I_{DM}$	Pulsed Drain Current ①	120	
$P_D @ T_C = 25^\circ C$	Power Dissipation	140	W
	Linear Derating Factor	0.91	W/°C
$V_{GS}$	Gate-to-Source Voltage	$\pm 16$	V
$E_{AS}$	Single Pulse Avalanche Energy②	310	mJ
$I_{AR}$	Avalanche Current①	18	A
$E_{AR}$	Repetitive Avalanche Energy①	14	mJ
dv/dt	Peak Diode Recovery dv/dt ③	5.0	V/ns
$T_J$	Operating Junction and Storage Temperature Range	-55 to + 175	°C
$T_{STG}$			
	Mounting torque, 6-32 or M3 srew	10 lbf•in (1.1N•m)	

## Thermal Resistance

	Parameter	Typ.	Max.	Units
$R_{\theta JC}$	Junction-to-Case	—	1.1	°C/W
$R_{\theta CS}$	Case-to-Sink, Flat, Greased Surface	0.50	—	
$R_{\theta JA}$	Junction-to-Ambient	—	62	

## Electrical Characteristics @ T<sub>J</sub> = 25°C (unless otherwise specified)

	Parameter	Min.	Typ.	Max.	Units	Conditions
V <sub>(BR)DSS</sub>	Drain-to-Source Breakdown Voltage	100	—	—	V	V <sub>GS</sub> = 0V, I <sub>D</sub> = 250μA
ΔV <sub>(BR)DSS/ΔT<sub>J</sub></sub>	Breakdown Voltage Temp. Coefficient	—	0.11	—	V/°C	Reference to 25°C, I <sub>D</sub> = 1mA
R <sub>DS(on)</sub>	Static Drain-to-Source On-Resistance	—	—	0.044	Ω	V <sub>GS</sub> = 10V, I <sub>D</sub> = 18A ④
		—	—	0.053		V <sub>GS</sub> = 5.0V, I <sub>D</sub> = 18A ④
		—	—	0.063		V <sub>GS</sub> = 4.0V, I <sub>D</sub> = 15A ④
V <sub>GS(th)</sub>	Gate Threshold Voltage	1.0	—	2.0	V	V <sub>DS</sub> = V <sub>GS</sub> , I <sub>D</sub> = 250μA
g <sub>fs</sub>	Forward Transconductance	14	—	—	S	V <sub>DS</sub> = 25V, I <sub>D</sub> = 18A
I <sub>DSS</sub>	Drain-to-Source Leakage Current	—	—	25	μA	V <sub>DS</sub> = 100V, V <sub>GS</sub> = 0V
		—	—	250		V <sub>DS</sub> = 80V, V <sub>GS</sub> = 0V, T <sub>J</sub> = 150°C
I <sub>GSS</sub>	Gate-to-Source Forward Leakage	—	—	100	nA	V <sub>GS</sub> = 16V
	Gate-to-Source Reverse Leakage	—	—	-100		V <sub>GS</sub> = -16V
Q <sub>g</sub>	Total Gate Charge	—	—	74	nC	I <sub>D</sub> = 18A
Q <sub>gs</sub>	Gate-to-Source Charge	—	—	9.4		V <sub>DS</sub> = 5.0V
Q <sub>gd</sub>	Gate-to-Drain ("Miller") Charge	—	—	38		V <sub>GS</sub> = 5.0V, See Fig. 6 and 13 ④
t <sub>d(on)</sub>	Turn-On Delay Time	—	11	—	ns	V <sub>DD</sub> = 50V
t <sub>r</sub>	Rise Time	—	81	—		I <sub>D</sub> = 18A
t <sub>d(off)</sub>	Turn-Off Delay Time	—	39	—		R <sub>G</sub> = 5.0Ω, V <sub>GS</sub> = 5.0V
t <sub>f</sub>	Fall Time	—	62	—		R <sub>D</sub> = 2.7Ω, See Fig. 10 ④
L <sub>D</sub>	Internal Drain Inductance	—	4.5	—	nH	Between lead, 6mm (0.25in.) from package and center of die contact
L <sub>S</sub>	Internal Source Inductance	—	7.5	—		
C <sub>iss</sub>	Input Capacitance	—	1800	—	pF	V <sub>GS</sub> = 0V
C <sub>oss</sub>	Output Capacitance	—	350	—		V <sub>DS</sub> = 25V
C <sub>riss</sub>	Reverse Transfer Capacitance	—	170	—		f = 1.0MHz, See Fig. 5

## Source-Drain Ratings and Characteristics

	Parameter	Min.	Typ.	Max.	Units	Conditions
I <sub>S</sub>	Continuous Source Current (Body Diode)	—	—	36	A	MOSFET symbol showing the integral reverse p-n junction diode.
I <sub>SM</sub>	Pulsed Source Current (Body Diode) ① ②	—	—	120		
V <sub>SD</sub>	Diode Forward Voltage	—	—	1.3	V	T <sub>J</sub> = 25°C, I <sub>S</sub> = 18A, V <sub>GS</sub> = 0V ④
t <sub>rr</sub>	Reverse Recovery Time	—	190	290	ns	T <sub>J</sub> = 25°C, I <sub>F</sub> = 18A
Q <sub>rr</sub>	Reverse Recovery Charge	—	1.1	1.7	μC	di/dt = 100A/μs ④
t <sub>on</sub>	Forward Turn-On Time	Intrinsic turn-on time is negligible (turn-on is dominated by L <sub>S</sub> +L <sub>D</sub> )				

### Notes:

- ① Repetitive rating; pulse width limited by max. junction temperature. ( See fig. 11 )  
 ② Starting T<sub>J</sub> = 25°C, L = 1.9mH  
 R<sub>G</sub> = 25Ω, I<sub>AS</sub> = 18A. (See Figure 12)

- ③ I<sub>SD</sub> ≤ 18A, di/dt ≤ 180A/μs, V<sub>DD</sub> ≤ V<sub>(BR)DSS</sub>,  
 T<sub>J</sub> ≤ 175°C  
 ④ Pulse width ≤ 300μs; duty cycle ≤ 2%

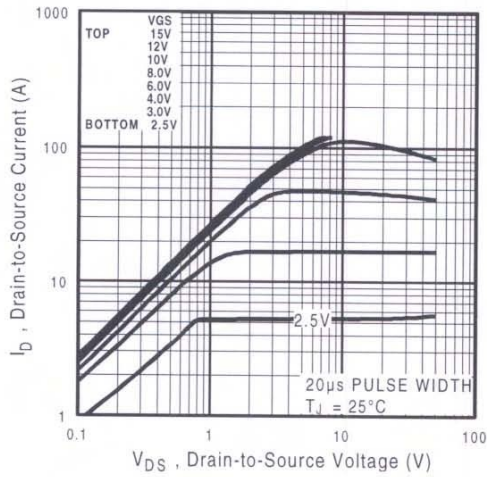

Fig 1. Typical Output Characteristics

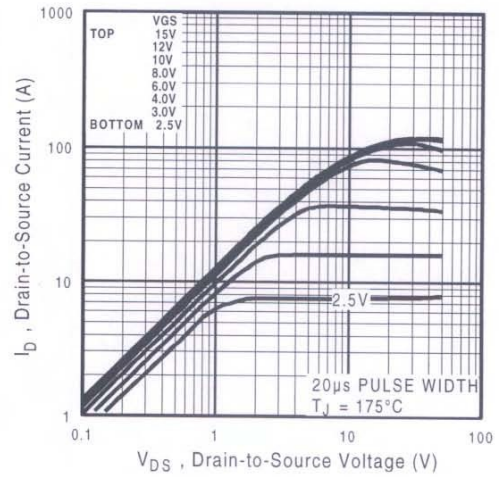

Fig 2. Typical Output Characteristics

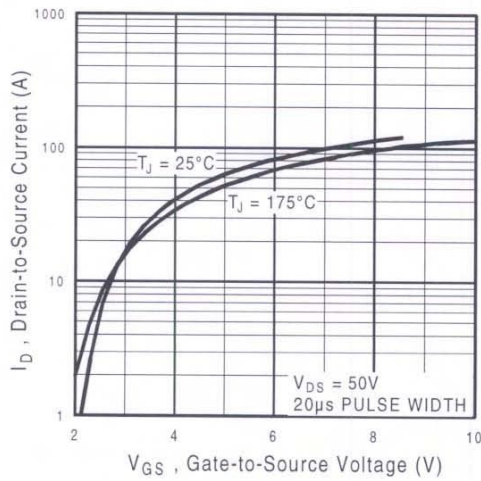

Fig 3. Typical Transfer Characteristics

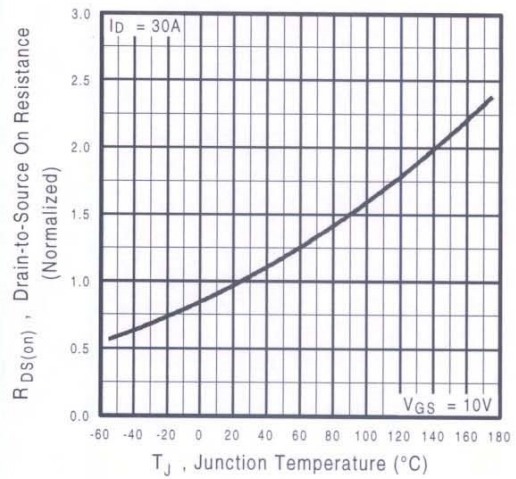
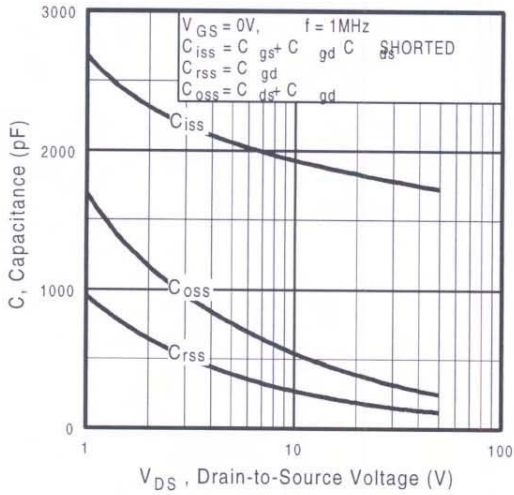

Fig 4. Normalized On-Resistance Vs. Temperature

# IRL540NPbF

International  
**IRF** Rectifier



**Fig 5.** Typical Capacitance Vs. Drain-to-Source Voltage

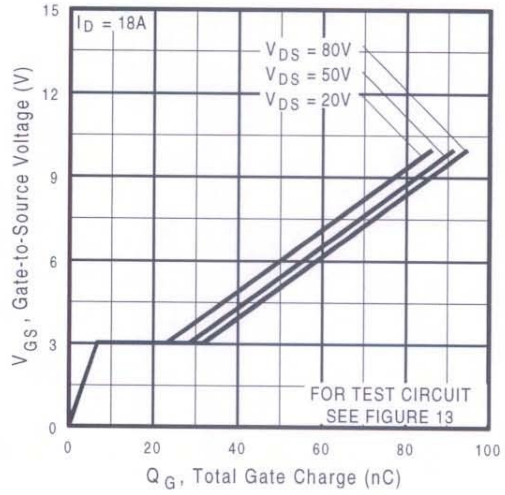

**Fig 6.** Typical Gate Charge Vs. Gate-to-Source Voltage

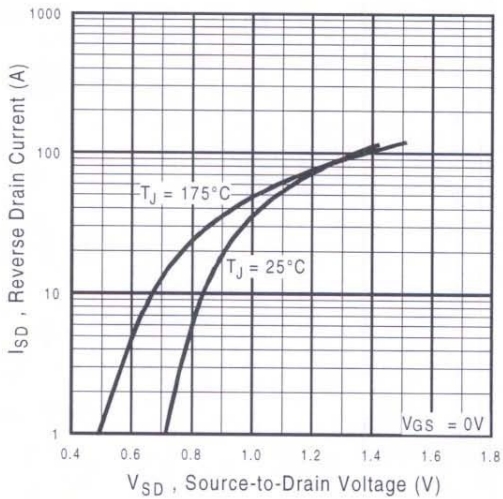

**Fig 7.** Typical Source-Drain Diode Forward Voltage

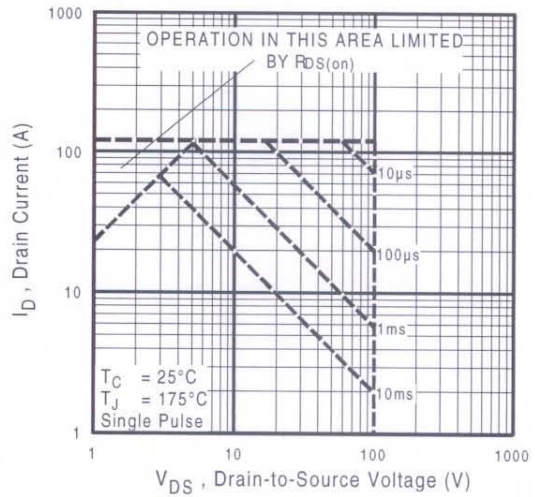

**Fig 8.** Maximum Safe Operating Area

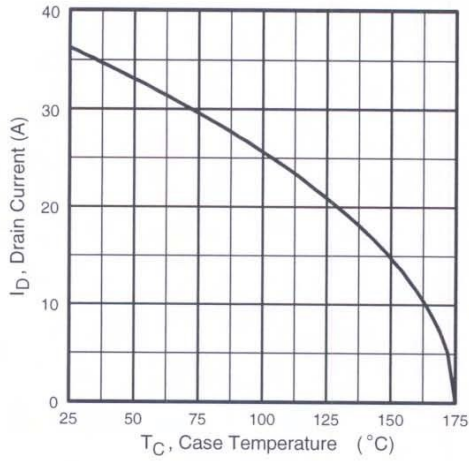

**Fig 9.** Maximum Drain Current Vs. Case Temperature

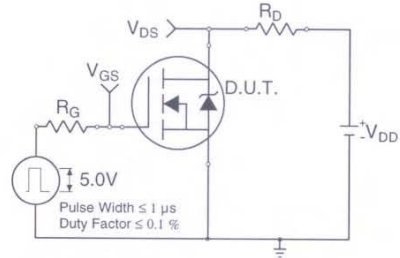

**Fig 10a.** Switching Time Test Circuit

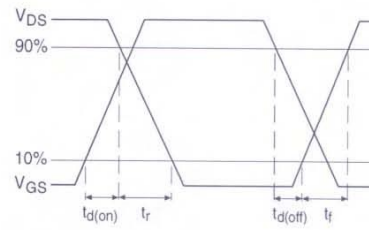

**Fig 10b.** Switching Time Waveforms

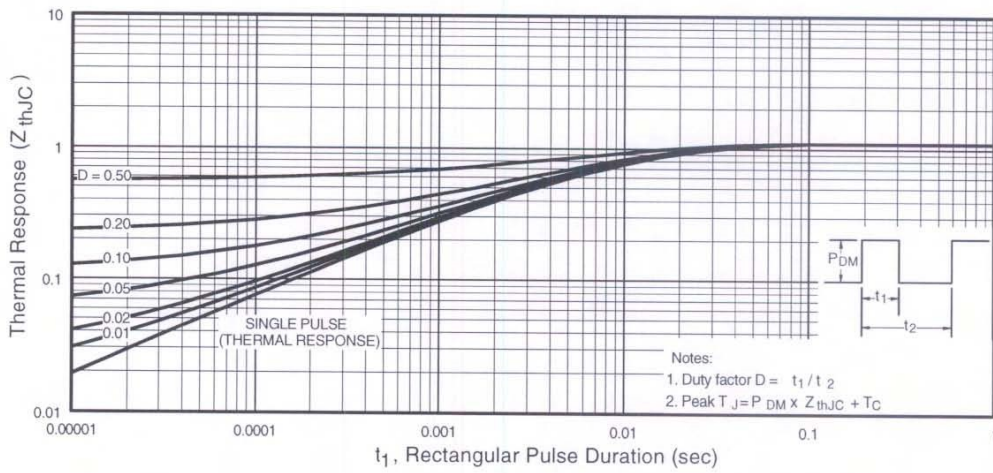

**Fig 11.** Maximum Effective Transient Thermal Impedance, Junction-to-Case

# IRL540NPbF

International  
**IR** Rectifier

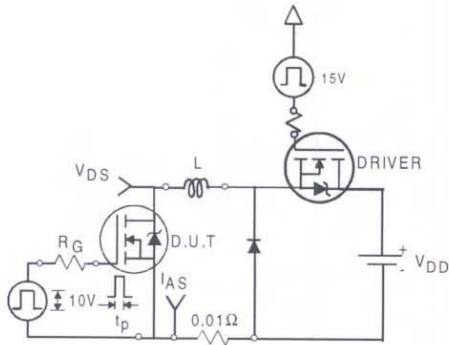

**Fig 12a.** Unclamped Inductive Test Circuit

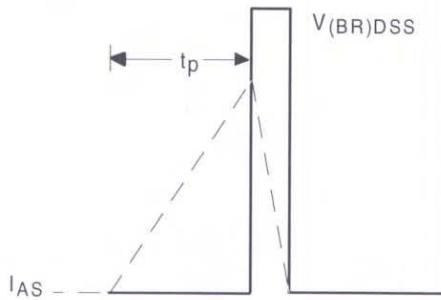

**Fig 12b.** Unclamped Inductive Waveforms

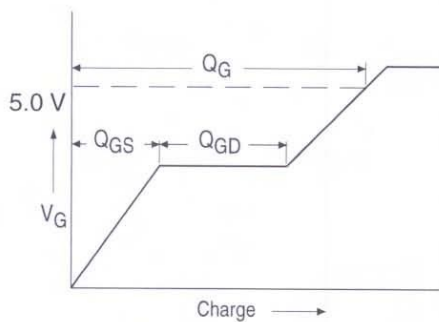

**Fig 13a.** Basic Gate Charge Waveform

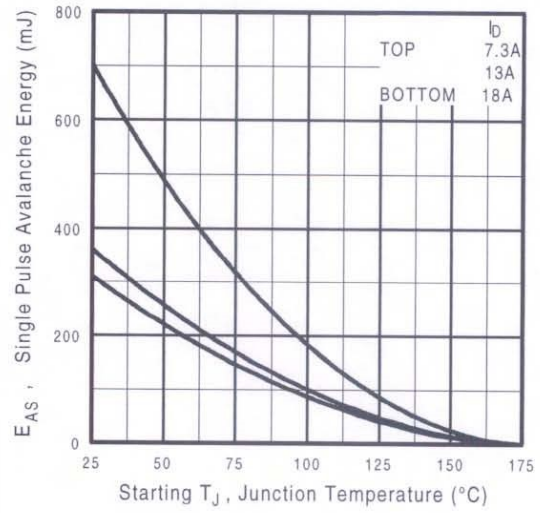

**Fig 12c.** Maximum Avalanche Energy Vs. Drain Current

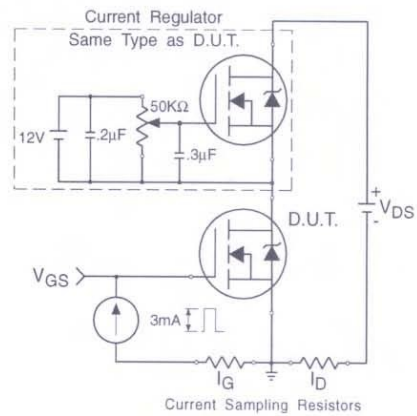

**Fig 13b.** Gate Charge Test Circuit

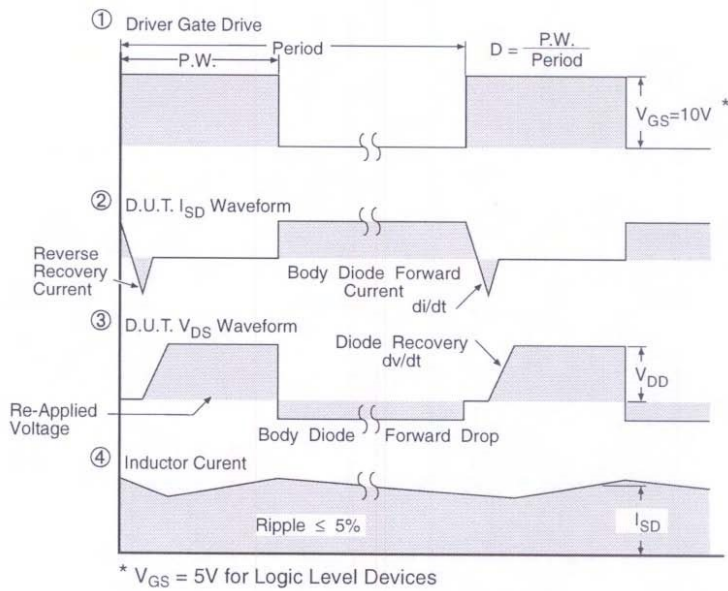
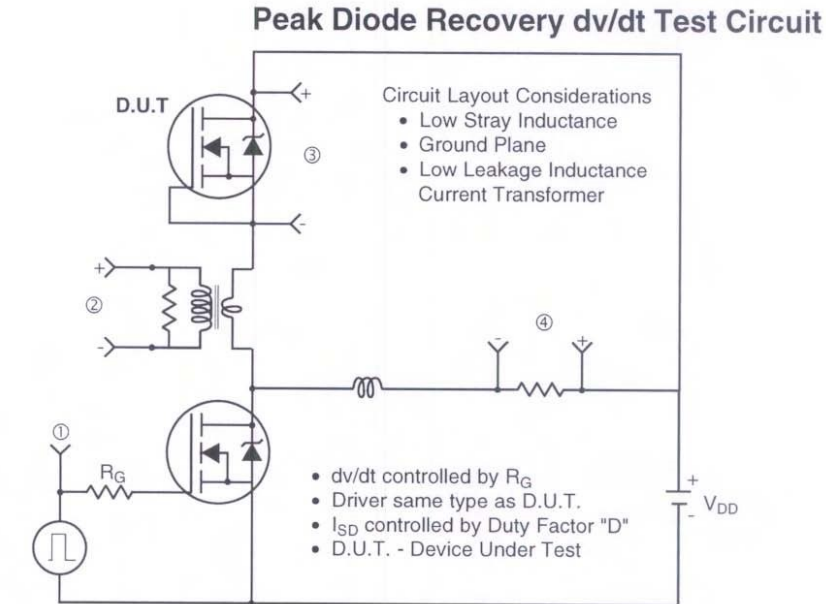

**Fig 14.** For N-Channel HEXFETS

# IRL540NPbF

International  
**IR** Rectifier

## TO-220AB Package Outline

Dimensions are shown in millimeters (inches)

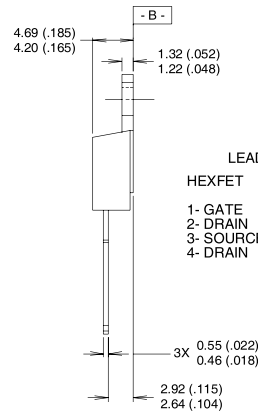
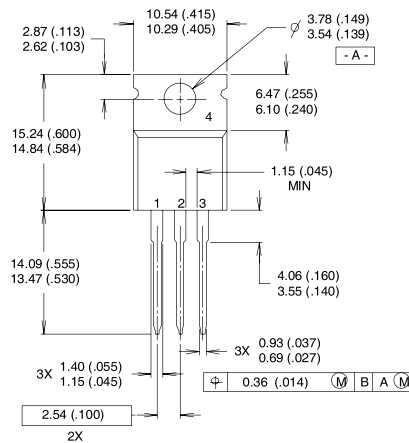

LEAD ASSIGNMENTS

HEXFET	IGBTs, CoPACK
1- GATE	1- GATE
2- DRAIN	2- COLLECTOR
3- SOURCE	3- EMITTER
4- DRAIN	4- COLLECTOR

NOTES:

- 1 DIMENSIONING & TOLERANCING PER ANSI Y14.5M, 1982.
- 2 CONTROLLING DIMENSION : INCH

- 3 OUTLINE CONFORMS TO JEDEC OUTLINE TO-220AB.
- 4 HEATSINK & LEAD MEASUREMENTS DO NOT INCLUDE BURRS.

## TO-220AB Part Marking Information

EXAMPLE: THIS IS AN IRF1010  
 LOT CODE 1789  
 ASSEMBLED ON WW 19, 1997  
 IN THE ASSEMBLY LINE "C"  
**Note:** "P" in assembly line  
 position indicates "Lead-Free"

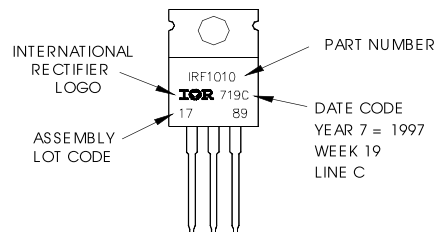

Data and specifications subject to change without notice.

International  
**IR** Rectifier

IR WORLD HEADQUARTERS: 233 Kansas St., El Segundo, California 90245, USA Tel: (310) 252-7105  
 TAC Fax: (310) 252-7903

Visit us at [www.irf.com](http://www.irf.com) for sales contact information.02/04

[www.irf.com](http://www.irf.com)



Note: For the most current drawings please refer to the IR website at:  
<http://www.irf.com/package/>