

T-41-73

GP1S58 Compact Potointerrupter

■ Features

1. Compact type
2. High sensing accuracy (Slit width : 0.5mm)
3. PWB mounting type
4. With positioning pin

■ Applications

1. OA equipment, such as FDDs, printers, facsimiles
2. VCRs

■ Outline Dimensions (Unit : mm)

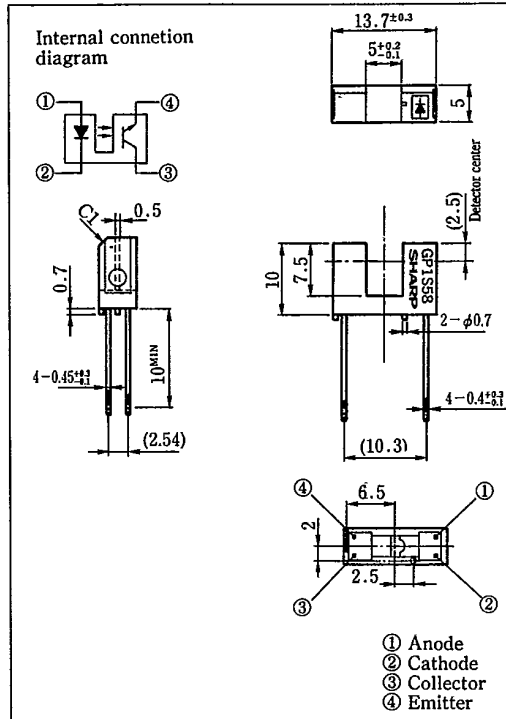

■ Absolute Maximum Ratings

(Ta=25°C)

	Parameter	Symbol	Rating	Unit
Input	Forward current	I_F	50	mA
	*1 Peak forward current	I_{FM}	1	A
	Reverse voltage	V_R	6	V
	Power dissipation	P	75	mW
Output	Collector-emitter voltage	V_{CEO}	35	V
	Emitter-collector voltage	V_{ECO}	6	V
	Collector current	I_C	20	mA
	Collector power dissipation	P_C	75	mW
	Operating temperature	T_{opr}	-25 ~ +85	°C
	Storage temperature	T_{stg}	-40 ~ +100	°C
	*2 Soldering temperature	T_{sol}	260	°C

*1 Pulse width ≤ 100μs, Duty ratio = 0.01

*2 For 5 seconds



T-41-73

Electro-optical Characteristics

(Ta=25°C)

	Parameter	Symbol	Conditions	MIN.	TYP.	MAX.	Unit
Input	Forward voltage	V_F	$I_F=20\text{mA}$	—	1.2	1.4	V
	Peak forward voltage	V_{FM}	$I_{FM}=0.5\text{A}$	—	3	4	V
	Reverse current	I_R	$V_R=3\text{V}$	—	—	10	μA
Output	Collector dark current	I_{CEO}	$V_{CE}=20\text{V}$	—	10^{-9}	10^{-7}	A
Transfer characteristics	Current transfer ratio	CTR	$I_F=20\text{mA}, V_{CE}=5\text{V}$	2.5	—	75	%
	Collector-emitter saturation voltage	$V_{CE(sat)}$	$I_F=40\text{mA}, I_C=0.5\text{mA}$	—	—	0.4	V
	Response time (Rise)	t_r	$V_{CE}=2\text{V}, I_C=2\text{mA}$	—	3	15	μs
	Response time (Fall)	t_f	$R_L=100\Omega$	—	4	20	μs

Fig. 1 Forward Current vs. Ambient Temperature

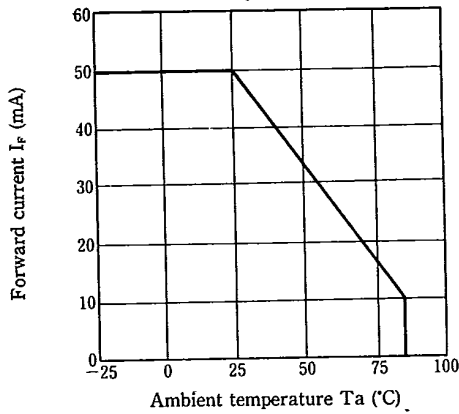

Fig. 2 Collector Power Dissipation vs. Ambient Temperature

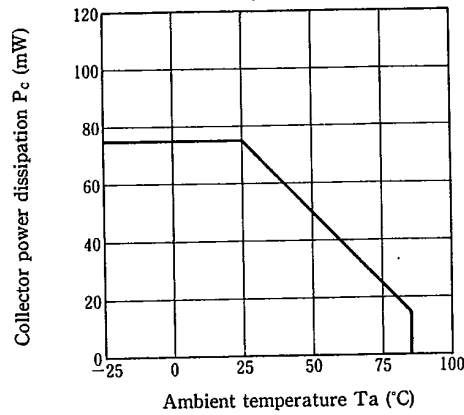

Fig. 3 Peak Forward Current vs. Duty Ratio

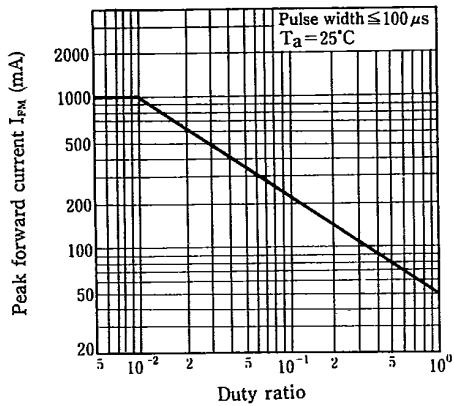
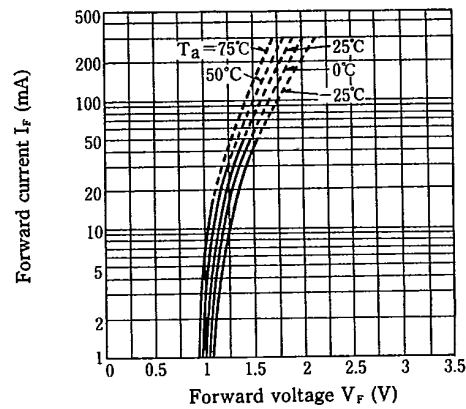

Fig. 4 Forward Current vs. Forward Voltage



T-41-73

Fig. 5 Collector Current vs. Forward Current

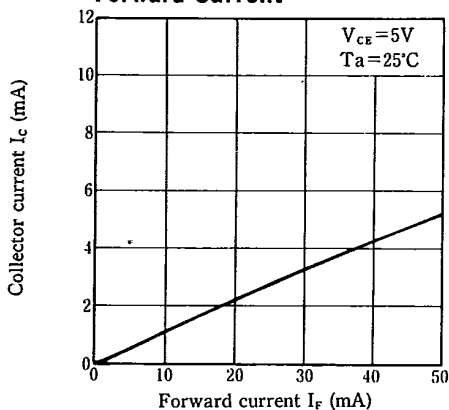

Fig. 6 Collector Current vs. Collector-emitter Voltage

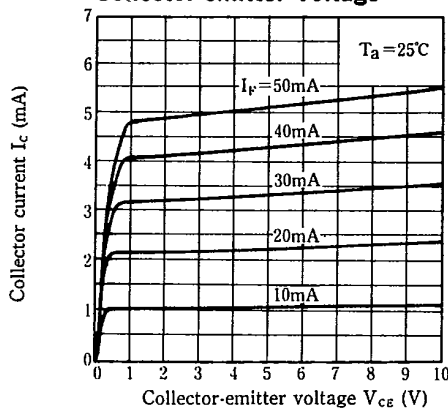

Fig. 7 Collector Current vs. Ambient Temperature

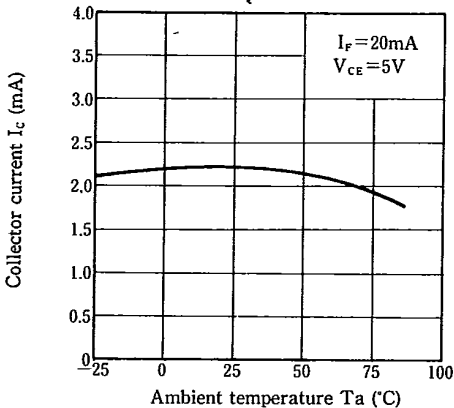

Fig. 8 Collector-emitter Saturation Voltage vs. Ambient Temperature

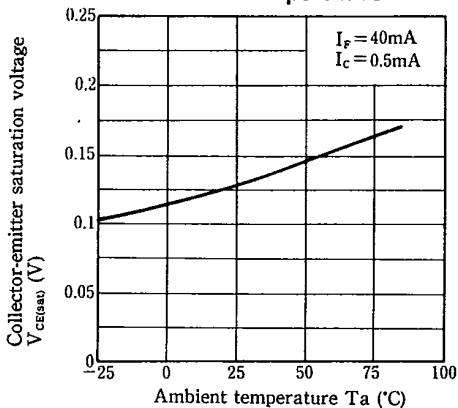
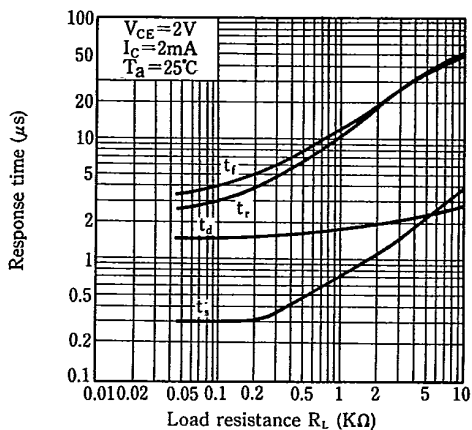
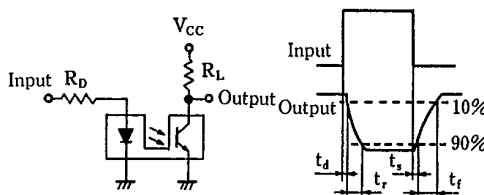

Fig. 9 Response Time vs. Load Resistance



Test Circuit for Response Time



T-41-73

Fig. 10 Frequency Response

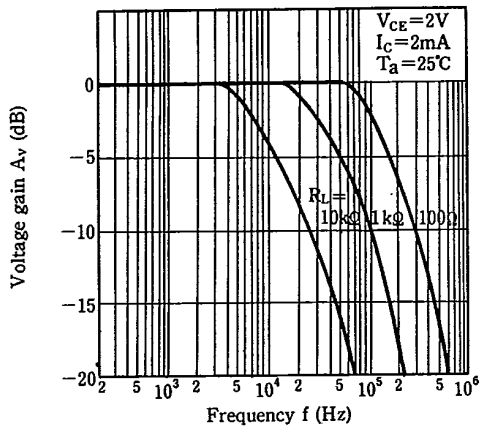

Fig. 11 Collector Dark Current vs. Ambient Temperature

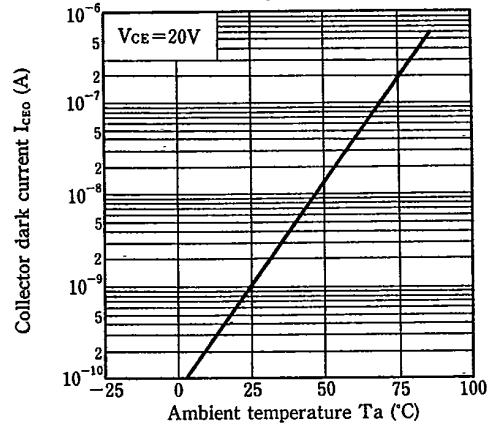

Fig. 12 Relative Collector Current vs. Shield Distance (1)

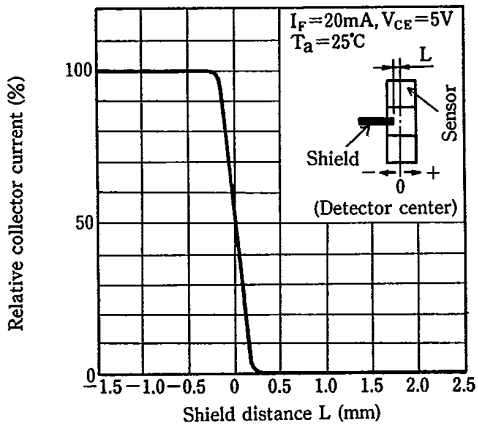

Fig. 13 Relative Collector Current vs. Shield Distance (2)

