

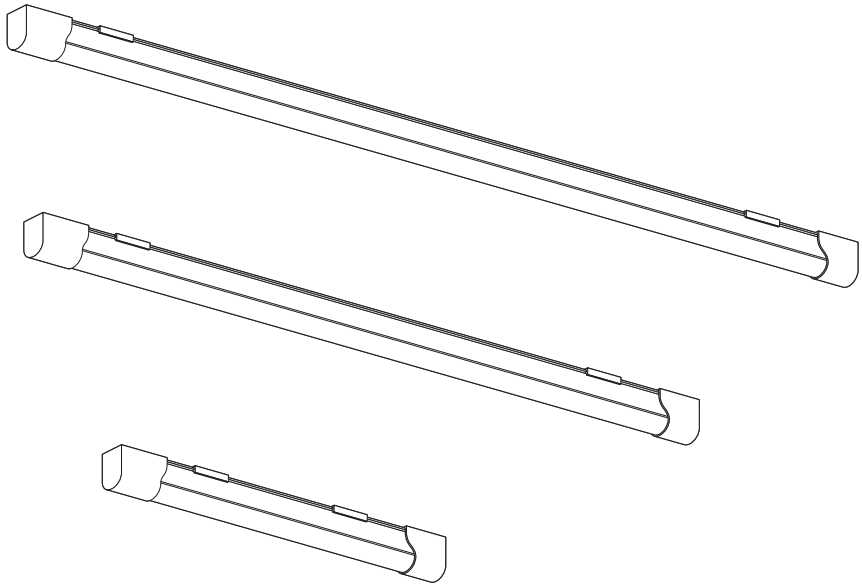







# LED VALUE BATTEN

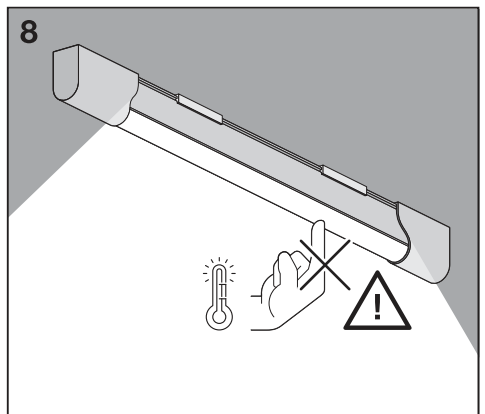
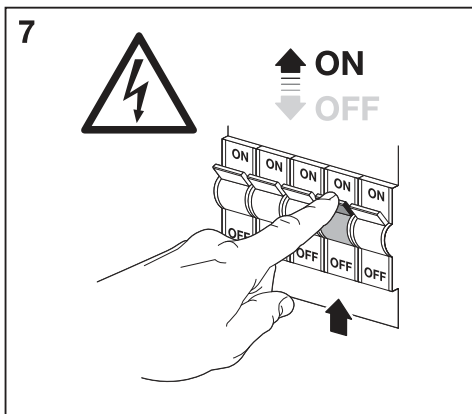
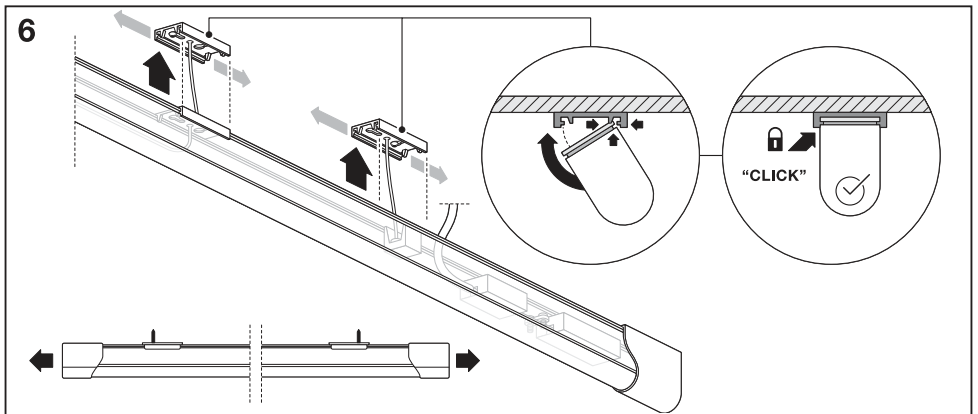
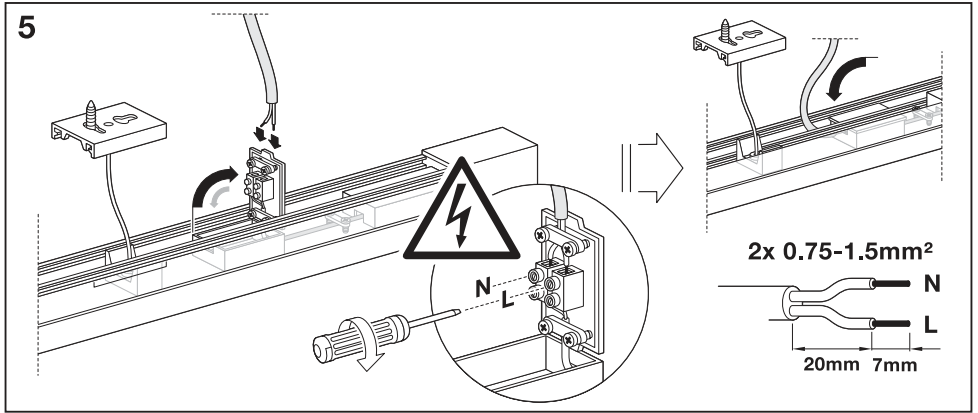

































	EAN	W	lm light source	lm output	K	⊖ (°C)	V~	mA	Hz	DF	▽ (°)	
<b>LED VALUE BATTEN 0.6M 10W/840</b>	4099854532832	10	1300	1000	4000	-20...+40	220-240	75	50/60	>0.7	150	100000
<b>LED VALUE BATTEN 1.2M 20W/840</b>	4099854532894	20	2500	2000	4000	-20...+40	220-240	150	50/60	>0.7	150	100000
<b>LED VALUE BATTEN 1.5M 24W/840</b>	4099854532955	24	3000	2400	4000	-20...+40	220-240	180	50/60	>0.7	150	100000



















				
	EAN	n		 <b>ENERGY</b> * X =
<b>LED VALUE BATTEN 0.6M 10W/840</b>	4099854532832	1	AC34729	 E
<b>LED VALUE BATTEN 1.2M 20W/840</b>	4099854532894	1	AC34730	 E
<b>LED VALUE BATTEN 1.5M 24W/840</b>	4099854532955	1	AC34731	 E

\*  Dieses Produkt enthält eine Lichtquelle der Energieeffizienzklasse <X>.  This product contains a light source of energy efficiency class <X>.  Ce produit contient une source lumineuse de classe d'efficacité énergétique <X>.  Questo prodotto contiene una sorgente luminosa di classe di efficienza energetica <X>.  Este producto contiene una fuente luminosa de la clase de eficiencia energética <X>.  Este produto contém uma fonte de luz da classe de eficiência energética <X>.  Το προϊόν αυτό περιέχει φωτεινή πηγή της τάξης ενεργειακής απόδοσης <X>.  Dit product bevat een lichtbron van energie-efficiëntieklasse <X>.  Denna produkt innehåller en ljuskälla med energieeffektivitetsklass <X>.  Tämä tuote sisältää valonlähteen, jonka energiatehokkuusluokka on <X>.  Dette produktet inneholder en lyskilde med energieffektivitetsklasse <X>.  Dette produkt indeholder en lyskilde i energieffektivitetsklasse <X>.  Tento výrobek obsahuje světelný zdroj s třídou energetické účinnosti <X>.  Данный продукт содержит энергосберегающий источник света (класса <X>).  Ez a termék egy <X> energiatékonysági osztályú fényforrást tartalmaz.  Ten produkt zawiera źródło światła o klasie efektywności energetycznej <X>.  Tento výrobek obsahuje svetelný zdroj triedy energetickej účinnosti <X>.  Ta izdelek vsebuje svetlobni vir razreda enerjske učinkovitosti <X>.  Bu ürün, enerji verimliliği sınıfında bir ışık kaynağı içerir <X>.  Ovaj proizvod sadrži izvora svetlosti klase energetske učinkovitosti <X>.  Acest produs conține o sursă de lumină cu clasă de eficiență energetică <X>.  Тоzi продукт включва светлинен източник с клас на енергийна ефективност <X>.  Toode sisaldab energiatõhususe klassi <X> valgusallikat.  Šiame gaminyje yra šviesos šaltinis, kurio energijos vartojimo efektyvumo klasė <X>.  Ši s ražojums satur gaismas avotu, kura energoefektivitātes klase ir <X>.  Ovaj proizvod sadrži izvor svetlosti klase energetske efikasnosti <X>.  Цей виріб містить джерело світла класу енергоефективності <X>.  Бұл өнімде <X> энергия тиімділігі класының жарық көзі бар.









**Cet appareil et ses accessoires se recyclent**

**À DÉPOSER EN MAGASIN**

**À DÉPOSER EN DÉCHÈTERIE**

**OU**

Points de collecte sur [www.quefairedemesdechets.fr](http://www.quefairedemesdechets.fr)



**LEDVANCE SASU**  
 CQM, 5 rue d'Altorf  
 67120 Molsheim France  
[www.ledvance.com](http://www.ledvance.com)

 **LEDVANCE Ltd**, Sterling House,  
 810 Mandarin Court, Warrington,  
 Cheshire, WA1 1GG, United Kingdom

G11225460  
 18.02.2025