

**HDSP-AX11/-AX13 Series, HDSP-FX11/-FX13 Series
 HDSP-HX11/-HX13 Series, HDSP-KX11/-KX13 Series**
 Black Surface Seven Segment Displays



Data Sheet



Description

These devices use industry-standard size package and pinout. Available with black surface finish. All devices are available as either common anode or common cathode.

Typical applications include appliances, channel indicators of TV, CATV converters, game machines, and point of sale terminals.

Features

- Black surface and color tinted epoxy
- Industry standard size
- Industry standard pinout
- Choice of character size
7.6 mm (0.30 in.), 10 mm (0.40 in.),
14.2 mm (0.56 in.)
- Choice of colors
AlGaAs Red, High Efficiency Red (HER), Green,
Orange
- Excellent appearance
Evenly lighted segments
± 50° Viewing angle
- Design flexibility
Common anode or common cathode
Single and two digit
- Categorized for luminous intensity
Categorized for color: Green
Use of like categories yields a uniform display
- Excellent for long digit string multiplexing

Devices

| Orange HDSP- | AlGaAs Red HDSP- | HER HDSP- | Green HDSP- | Description | Package Drawing |
|-----------------|------------------------|--------------|----------------|---|--------------------|
| | A111 | A211 | A511 | 7.6 mm Common Anode Right Hand Decimal | A |
| A413 | A113 | A213 | A513 | 7.6 mm Common Cathode Right Hand Decimal | B |
| | F111 | F211 | F511 | 10 mm Common Anode Right Hand Decimal | C |
| F413 | F113 | F213 | F513 | 10 mm Common Cathode Right Hand Decimal | D |
| | H111 | H211 | H511 | 14.2 mm Common Anode Right Hand Decimal | G |
| H413 | H113 | H213 | H513 | 14.2 mm Common Cathode Right Hand Decimal | H |
| | K111 | K211 | K511 | 14.2 mm Two Digit Common Anode Right Hand Decimal | I |
| | K113 | K213 | K513 | 14.2 mm Two Digit Common Cathode Right Hand Decimal | J |

Part Numbering System

5082-X X X X-X X X X X

HDSP-X X X X-X X X X X

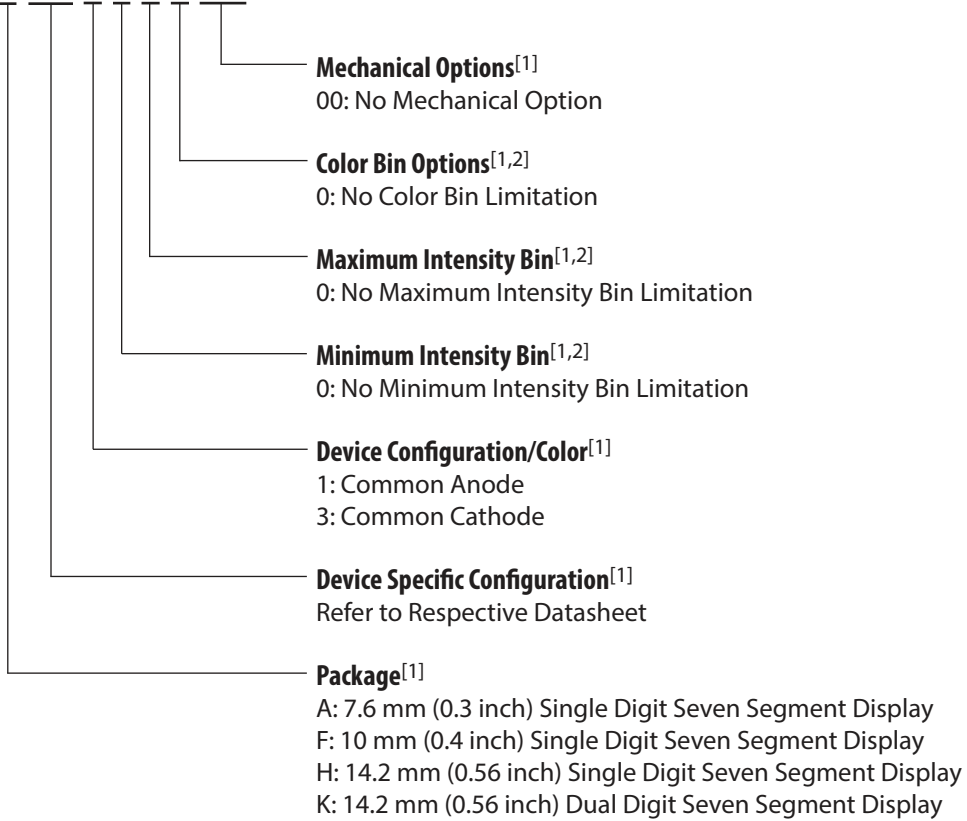

Notes:

1. For codes not listed in the figure above, please refer to the respective datasheet or contact your nearest Avago representative for details.
2. Bin options refer to shippable bins for a part number. Color and Intensity Bins are typically restricted to 1 bin per tube (exceptions may apply). Please refer to respective datasheet for specific bin limit information.

Package Dimensions (7.6 mm Series)

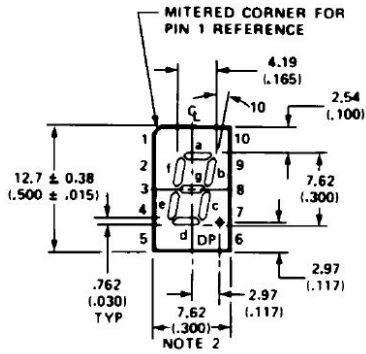

A, B

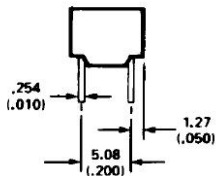

A, B

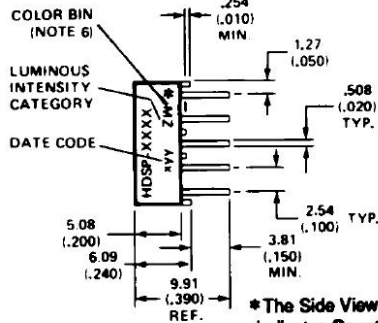

| PIN | FUNCTION | |
|-----|----------------------|------------------------|
| | A | B |
| 1 | ANODE ^[4] | CATHODE ^[5] |
| 2 | CATHODE f | ANODE f |
| 3 | CATHODE g | ANODE g |
| 4 | CATHODE e | ANODE e |
| 5 | CATHODE d | ANODE d |
| 6 | ANODE ^[4] | CATHODE ^[5] |
| 7 | CATHODE DP | ANODE DP |
| 8 | CATHODE c | ANODE c |
| 9 | CATHODE b | ANODE b |
| 10 | CATHODE a | ANODE a |

- NOTES:
1. ALL DIMENSIONS IN MILLIMETERS (INCHES).
 2. MAXIMUM.
 3. ALL UNTOLERANCED DIMENSIONS ARE FOR REFERENCE ONLY.
 4. REDUNDANT ANODES.
 5. REDUNDANT CATHODES.
 6. FOR HDSP-A511/-A513 ONLY.

Internal Circuit Diagram

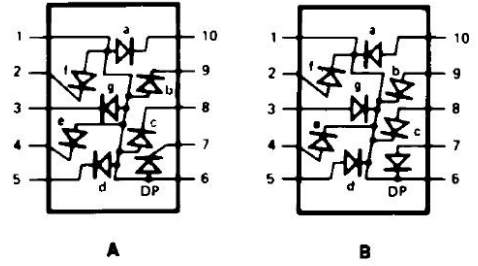

A

B

Package Dimensions (10 mm Series: Single)

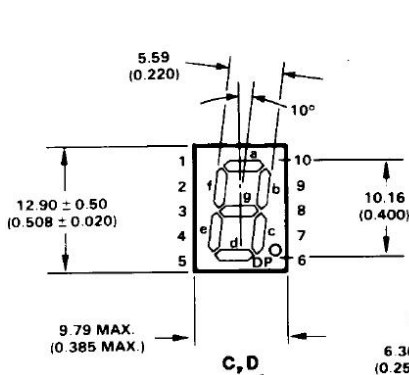

C, D

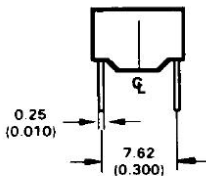

C, D

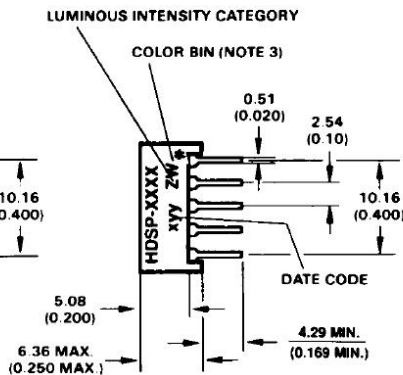

C, D

| PIN | FUNCTION | |
|-----|----------------------|------------------------|
| | C | D |
| 1 | ANODE ^[4] | CATHODE ^[5] |
| 2 | CATHODE f | ANODE f |
| 3 | CATHODE g | ANODE g |
| 4 | CATHODE e | ANODE e |
| 5 | CATHODE d | ANODE d |
| 6 | ANODE ^[4] | CATHODE ^[5] |
| 7 | CATHODE DP | ANODE DP |
| 8 | CATHODE c | ANODE c |
| 9 | CATHODE b | ANODE b |
| 10 | CATHODE a | ANODE a |

- NOTES:
1. ALL DIMENSIONS IN MILLIMETERS (INCHES).
 2. ALL UNTOLERANCED DIMENSIONS ARE FOR REFERENCE ONLY.
 3. FOR HDSP-F511/-F513 ONLY.
 4. REDUNDANT ANODES.
 5. REDUNDANT CATHODES.

Internal Circuit Diagram

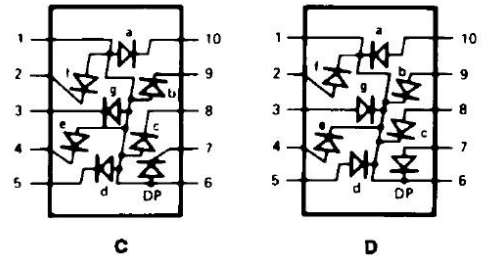

C

D

Package Dimensions (14.2 mm Series: Single)

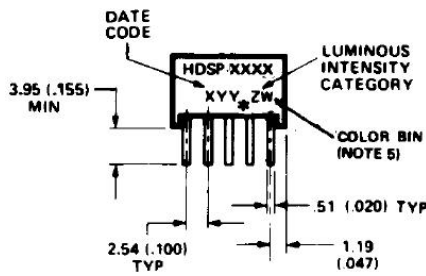
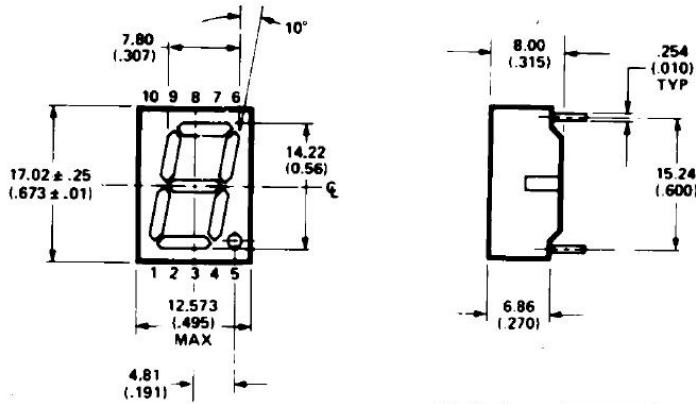

G, H

* The End View of package indicates Country of Origin.

| PIN | FUNCTION | |
|-----|------------|-------------|
| | G | H |
| 1 | CATHODE e | ANODE e |
| 2 | CATHODE d | ANODE d |
| 3 | ANODE [3] | CATHODE [4] |
| 4 | CATHODE c | ANODE c |
| 5 | CATHODE DP | ANODE DP |
| 6 | CATHODE b | ANODE b |
| 7 | CATHODE a | ANODE a |
| 8 | ANODE [3] | CATHODE [4] |
| 9 | CATHODE f | ANODE f |
| 10 | CATHODE g | ANODE g |

- NOTES:
 1. ALL DIMENSIONS IN MILLIMETERS (INCHES).
 2. ALL UNTOLERANCED DIMENSIONS ARE FOR REFERENCE ONLY.
 3. REDUNDANT ANODES.
 4. REDUNDANT CATHODES.
 5. FOR HDSP-HS11/HS13 ONLY.

Internal Circuit Diagram

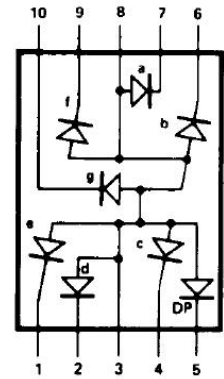

G

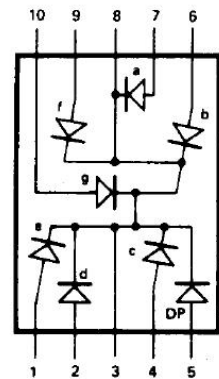

H

Package Dimensions (14.2 mm Series: Two Digit) Diagram

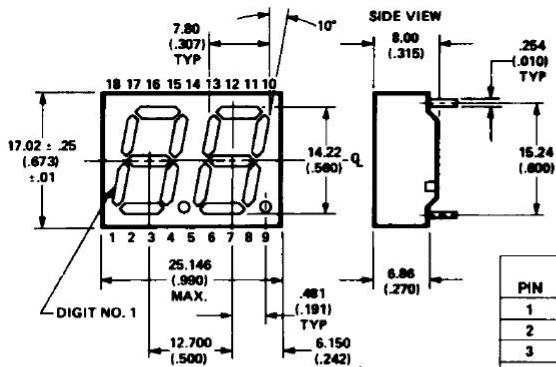

I, J

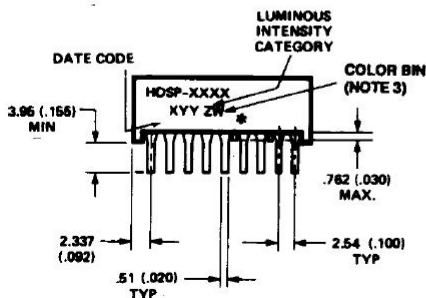

* The Side View of package indicates Country of Origin.

| PIN | FUNCTION | |
|-----|---------------------|----------------|
| | I | J |
| 1 | E CATHODE NO. 1 | E ANODE NO. 1 |
| 2 | D CATHODE NO. 1 | D ANODE NO. 1 |
| 3 | C CATHODE NO. 1 | C ANODE NO. 1 |
| 4 | DP CATHODE NO. 1 | DP ANODE NO. 1 |
| 5 | E CATHODE NO. 2 | E ANODE NO. 2 |
| 6 | D CATHODE NO. 2 | D ANODE NO. 2 |
| 7 | G CATHODE NO. 2 | G ANODE NO. 2 |
| 8 | C CATHODE NO. 2 | C ANODE NO. 2 |
| 9 | DP CATHODE NO. 2 | DP ANODE NO. 2 |
| 10 | B CATHODE NO. 2 | B ANODE NO. 2 |
| 11 | A CATHODE NO. 2 | A ANODE NO. 2 |
| 12 | F CATHODE NO. 2 | F ANODE NO. 2 |
| 13 | DIGIT NO. 2 ANODE | |
| 14 | DIGIT NO. 2 CATHODE | |
| 15 | B CATHODE NO. 1 | B ANODE NO. 1 |
| 16 | A CATHODE NO. 1 | A ANODE NO. 1 |
| 17 | G CATHODE NO. 1 | G ANODE NO. 1 |
| 18 | F CATHODE NO. 1 | F ANODE NO. 1 |

- NOTES:
 1. ALL DIMENSIONS IN MILLIMETERS (INCHES).
 2. ALL UNTOLERANCED DIMENSIONS ARE FOR REFERENCE ONLY.
 3. FOR HDSP-KS11/KS13 ONLY.

Internal Circuit Diagram

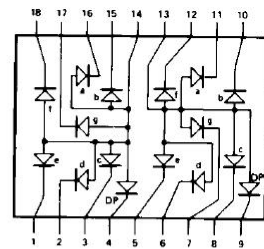

I

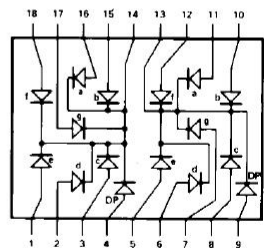

J

Absolute Maximum Ratings

| Description | AlGaAs Red HDSP-X11X Series | HER/Orange HDSP-X21X/X41X Series | Green HDSP-X51X Series | Units |
|--|-----------------------------------|--|------------------------------|-------|
| Average Power per Segment or DP | 37 | 105 | 105 | mW |
| Peak Forward Current per Segment or DP | 45 | 90 ^[1] | 90 ^[3] | mA |
| DC Forward Current per Segment or DP | 15 ^[5] | 30 ^[2] | 30 ^[4] | mA |
| Operating Temperature Range | -20 to +100 | -40 to +100 | | °C |
| Storage Temperature Range | | -55 to +100 | | °C |
| Reverse Voltage per Segment or DP | | 3.0 | | V |
| Wave Soldering Temperature for 3 Seconds (1.60 mm [0.063 in.] below Body) | | 250 | | °C |

Notes:

1. See Figure 5 to establish pulsed conditions.
2. Derate above 53°C at 0.45 mA/°C (see Figure 7).
3. See Figure 6 to establish pulsed conditions.
4. Derate above 39°C at 0.37 mA/°C (see Figure 7).
5. Derate above 91°C at 0.53 mA/°C (see Figure 1).

Electrical/Optical Characteristics at T_A = 25°C

AlGaAs Red

| Device Series HDSP- | Parameter | Symbol | Min. | Typ. | Max. | Units | Test Conditions |
|------------------------|--|---------------------|------|------|------|---------------|-----------------------------|
| A11X | Luminous Intensity/Segment ^[1,2] (Digit Average) | I _V | 315 | 600 | | μcd | I _F = 1 mA |
| | | | | 3600 | | | I _F = 5 mA |
| F11X, | | | 330 | 650 | | | I _F = 1 mA |
| | | | | 3900 | | | I _F = 5 mA |
| H11X, K11X | | | 400 | 700 | | | I _F = 1 mA |
| | | | | 4200 | | | I _F = 5 mA |
| All Devices | Forward Voltage/Segment or DP | V _F | | 1.6 | 2.0 | V | I _F = 1 mA |
| | | | | 1.7 | | | I _F = 5 mA |
| | | | | 1.8 | 2.2 | | I _F = 20 mA Peak |
| | Peak Wavelength | λ _{PEAK} | | 645 | | nm | |
| | Dominant Wavelength ^[3] | λ _d | | 637 | | nm | |
| | Reverse Voltage/Segment or DP ^[4] | V _R | 3.0 | 15 | | V | I _R = 100 μA |
| | Temperature Coefficient of V _F /Segment or DP | ΔV _F /°C | | -2 | | mV/°C | |
| A11X | Thermal Resistance LED Junction-to-Pin | R _{θJ-PIN} | | 255 | | °C/W/ Seg. | |
| F11X | | | | 320 | | | |
| H11X, K12X | | | | 400 | | | |

Orange

| Device Series HDSP- | Parameter | Symbol | Min. | Typ. | Max. | Units | Test Conditions |
|------------------------|--|-----------------------------|------|------|------|-----------------------------|-------------------------|
| A413 | Luminous Intensity/Segment (Segment Average) ^[1,2] | I_V | | 0.70 | | mcd | $I_F = 5 \text{ mA}$ |
| F413 | | | | 1.0 | | | $I_F = 5 \text{ mA}$ |
| H413 | | | | 2.37 | | | $I_F = 10 \text{ mA}$ |
| All Devices | Forward Voltage/Segment or DP | V_F | | 2.0 | 2.5 | V | $I_F = 20 \text{ mA}$ |
| | Peak Wavelength | λ_{PEAK} | | 600 | | nm | |
| | Dominant Wavelength ^[3] | λ_d | | 603 | | nm | |
| | Reverse Voltage/Segment or DP ^[4] | V_R | 3.0 | 30 | | V | $I_R = 100 \mu\text{A}$ |
| | Temperature Coefficient of V_F /Segment or DP | $\Delta V_F/^\circ\text{C}$ | | -2 | | | mV/ $^\circ\text{C}$ |
| A413 | Thermal Resistance LED Junction-to-Pin | $R\theta_{J-PIN}$ | | 200 | | $^\circ\text{C/W/}$ Seg. | |
| F413 | | | | 320 | | | |
| H413 | | | | 345 | | | |

High Efficiency Red

| Device Series HDSP- | Parameter | Symbol | Min. | Typ. | Max. | Units | Test Conditions | |
|------------------------|--|-----------------------------|------|------|------|-----------------------------|--|-----------------------|
| A21X | Luminous Intensity/Segment ^[1,2] (Digit Average) | I_V | | 360 | 980 | μcd | $I_F = 5 \text{ mA}$ | |
| | | | | | 5390 | | | $I_F = 20 \text{ mA}$ |
| F21X | | | | 420 | 1200 | | $I_F = 5 \text{ mA}$ | |
| H21X, K21X | | | | 900 | 2800 | | $I_F = 10 \text{ mA}$ | |
| | | | | 3700 | | | $I_F = 60 \text{ mA Peak:}$ 1/6 Duty Factor | |
| All Devices | Forward Voltage/Segment or DP | V_F | | 2.0 | 2.5 | V | $I_F = 20 \text{ mA}$ | |
| | Peak Wavelength | λ_{PEAK} | | 635 | | nm | | |
| | Dominant Wavelength ^[3] | λ_d | | 626 | | nm | | |
| | Reverse Voltage/Segment or DP ^[4] | V_R | 3.0 | 30 | | V | $I_R = 100 \mu\text{A}$ | |
| | Temperature Coefficient of V_F /Segment or DP | $\Delta V_F/^\circ\text{C}$ | | -2 | | | mV/ $^\circ\text{C}$ | |
| A21X | Thermal Resistance LED Junction-to-Pin | $R\theta_{J-PIN}$ | | 200 | | $^\circ\text{C/W/}$ Seg. | | |
| F21X | | | | 320 | | | | |
| H21X, K21X | | | | 345 | | | | |

High Performance Green

| Device Series | Parameter | Symbol | Min. | Typ. | Max. | Units | Test Conditions | |
|---------------|--|-------------------------------|------|------|------|------------------------------------|---|-----------------------|
| A51X | Luminous Intensity/Segment ^[1,2] (Digit Average) | I_V | 860 | 3000 | | μcd | $I_F = 10 \text{ mA}$ | |
| | | | | 6800 | | | $I_F = 20 \text{ mA}$ | |
| F51X | | | | 1030 | | | 3500 | $I_F = 10 \text{ mA}$ |
| H51X, K51X | | | | 900 | | | 2500 | $I_F = 10 \text{ mA}$ |
| | | | | 3100 | | | $I_F = 60 \text{ mA Peak}$ 1/6 Duty Factor | |
| All Devices | Forward Voltage/Segment or DP | V_F | | 2.1 | 2.5 | V | $I_F = 10 \text{ mA}$ | |
| | Peak Wavelength | λ_{PEAK} | | 566 | | nm | | |
| | Dominant Wavelength ^[3,5] | λ_d | | 571 | 577 | nm | | |
| | Reverse Voltage/Segment or DP ^[4] | V_R | 3.0 | 50 | | V | $I_R = 100 \mu\text{A}$ | |
| | Temperature Coefficient of V_F /Segment or DP | $\Delta V_F / ^\circ\text{C}$ | | -2 | | $\text{mV}/^\circ\text{C}$ | | |
| A51X | Thermal Resistance LED Junction-to-Pin | $R\theta_{\text{J-PIN}}$ | | 200 | | $^\circ\text{C}/\text{W}/$ Seg. | | |
| F51X | | | | 320 | | | | |
| H51X, K51X | | | | 345 | | | | |

Notes:

1. Case temperature of device immediately prior to the intensity measurement is 25°C.
2. The digits are categorized for luminous intensity. The intensity category is designated by a letter on the side of the package.
3. The dominant wavelength, λ_d , is derived from the CIE chromaticity diagram and is that single wavelength which defines the color of the device.
4. Typical specification for reference only. Do not exceed absolute maximum ratings.
5. Green (HDSP-A51X/F51X/H512X/K51X) series displays are categorized for dominant wavelength. The category is designated by a number adjacent to the luminous intensity category letter.

AlGaAs Red

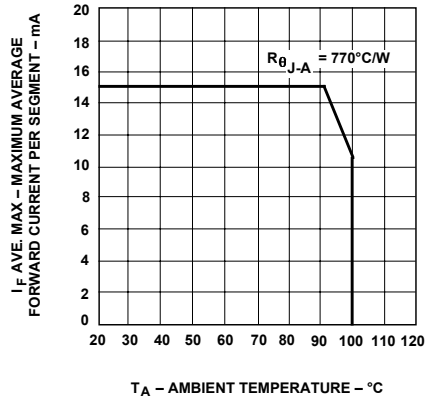

Figure 1. Maximum allowable average or dc current vs. ambient temperature.

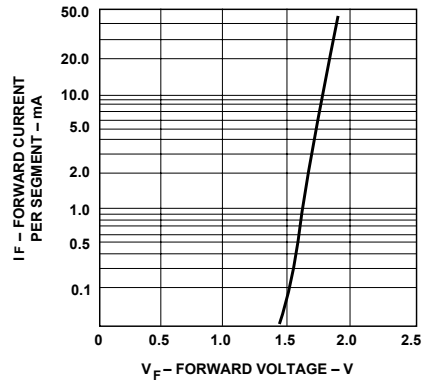

Figure 2. Forward current vs. forward voltage.

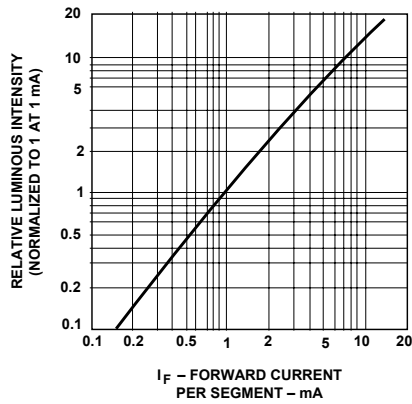

Figure 3. Relative luminous intensity vs. dc forward current.

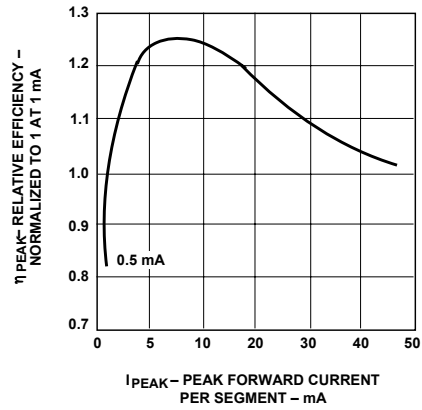

Figure 4. Relative efficiency (luminous intensity per unit current) vs. peak current.

HER, Green, Orange

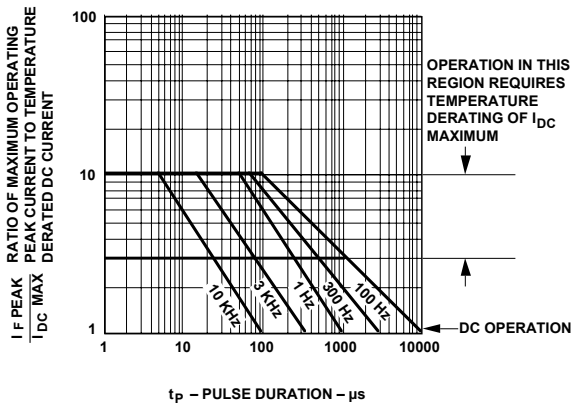

Figure 5. Maximum tolerable peak current vs. pulse duration – HER, Orange.

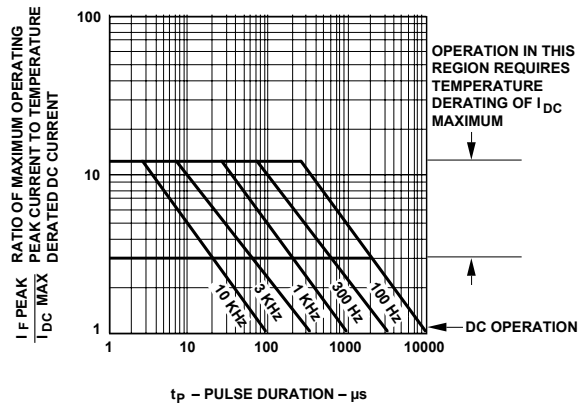

Figure 6. Maximum tolerable peak current vs. pulse duration – Green.

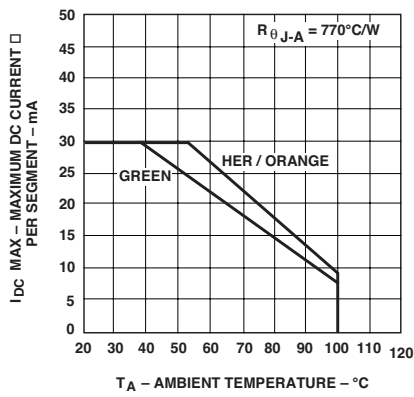

Figure 7. Maximum allowable dc current vs. ambient temperature.

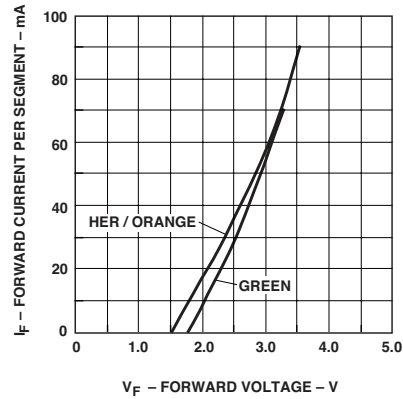

Figure 8. Forward current vs. forward voltage characteristics.

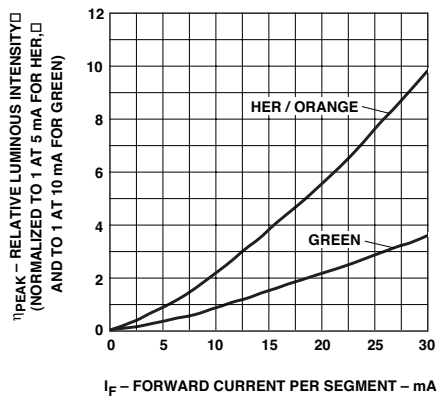

Figure 9. Relative luminous intensity vs. dc forward current.

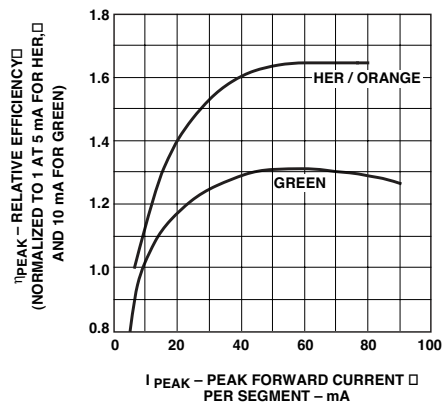

Figure 10. Relative efficiency (luminous intensity per unit current) vs. peak current.

Intensity Bin Limits (mcd)

AlGaAs Red

HDSP-A1xx

| IV Bin Category | Min. | Max. |
|-----------------|-------|-------|
| E | 0.315 | 0.520 |
| F | 0.428 | 0.759 |
| G | 0.621 | 1.16 |
| H | 0.945 | 1.71 |
| I | 1.40 | 2.56 |
| J | 2.10 | 3.84 |
| K | 3.14 | 5.75 |
| L | 4.70 | 8.55 |

HDSP-F1xx

| IV Bin Category | Min. | Max. |
|-----------------|-------|-------|
| D | 0.391 | 0.650 |
| E | 0.532 | 0.923 |
| F | 0.755 | 1.39 |
| G | 1.13 | 2.08 |
| H | 1.70 | 3.14 |

HDSP-H1xx/K1xx

| IV Bin Category | Min. | Max. |
|-----------------|-------|-------|
| C | 0.415 | 0.690 |
| D | 0.565 | 0.990 |
| E | 0.810 | 1.50 |
| F | 1.20 | 2.20 |
| G | 1.80 | 3.30 |
| H | 2.73 | 5.00 |
| I | 4.09 | 7.50 |

Orange

HDSP-A41X

| IV Bin Category | Min | Max |
|-----------------|-------|-------|
| A | 0.284 | 0.433 |
| B | 0.354 | 0.541 |
| C | 0.443 | 0.677 |
| D | 0.554 | 0.846 |
| E | 0.692 | 1.057 |
| F | 0.856 | 1.322 |
| G | 1.082 | 1.652 |
| H | 1.352 | 2.066 |
| I | 1.692 | 2.581 |
| J | 2.114 | 3.227 |
| K | 2.641 | 4.034 |
| L | 3.300 | 5.042 |
| M | 4.127 | 6.303 |
| N | 5.157 | 7.878 |

HDSP-F41X

| IV Bin Category | Min | Max |
|-----------------|-------|-------|
| C | 0.485 | 0.890 |
| D | 0.728 | 1.333 |
| E | 1.091 | 2.000 |
| F | 1.636 | 3.000 |
| G | 2.454 | 4.500 |
| H | 3.682 | 6.751 |

HDSP-H41X/K41X

| IV Bin Category | Min | Max |
|-----------------|------|------|
| B | 0.77 | 1.17 |
| C | 0.95 | 1.45 |
| D | 1.19 | 1.82 |
| E | 1.49 | 2.27 |
| F | 1.85 | 2.89 |
| G | 2.32 | 3.54 |
| H | 2.90 | 4.43 |

Intensity Bin Limits (mcd), continued**HER****HDSP-A2xx**

| IV Bin Category | Min. | Max. |
|------------------------|-------------|-------------|
| B | 0.342 | 0.630 |
| C | 0.516 | 0.946 |
| D | 0.774 | 1.418 |
| E | 1.160 | 2.127 |
| F | 1.740 | 3.190 |
| G | 2.610 | 4.785 |
| H | 3.915 | 7.177 |

HDSP-F2xx

| IV Bin Category | Min. | Max. |
|------------------------|-------------|-------------|
| C | 0.485 | 0.890 |
| D | 0.728 | 1.333 |
| E | 1.091 | 2.000 |
| F | 1.636 | 3.000 |
| G | 2.454 | 4.500 |
| H | 3.682 | 6.751 |

HDSP-H2xx/K2xx

| IV Bin Category | Min. | Max. |
|------------------------|-------------|-------------|
| E | 0.91 | 1.67 |
| F | 1.37 | 2.51 |
| G | 2.05 | 3.76 |
| H | 3.08 | 5.64 |
| I | 4.62 | 8.64 |
| J | 6.93 | 12.70 |
| K | 10.39 | 19.04 |

Intensity Bin Limits (mcd), continued**Green****HDSP-A5xx**

| IV Bin Category | Min. | Max. |
|------------------------|-------------|-------------|
| H | 0.86 | 1.58 |
| I | 1.29 | 2.37 |
| J | 1.94 | 3.55 |
| K | 2.90 | 5.33 |
| L | 4.37 | 8.01 |

HDSP-F5xx

| IV Bin Category | Min. | Max. |
|------------------------|-------------|-------------|
| H | 1.54 | 2.82 |
| I | 2.31 | 4.23 |
| J | 3.46 | 6.34 |
| K | 5.18 | 9.50 |
| L | 7.78 | 14.26 |

HDSP-H5xx/K5xx

| IV Bin Category | Min. | Max. |
|------------------------|-------------|-------------|
| E | 0.91 | 1.67 |
| F | 1.37 | 2.51 |
| G | 2.05 | 3.76 |
| H | 3.08 | 5.64 |
| I | 4.61 | 8.46 |

Color Categories

| Color | Bin | Dominant Wavelength (nm) | |
|-------|-----|--------------------------|--------|
| | | Min. | Max. |
| Green | 2 | 573.00 | 577.00 |
| | 3 | 570.00 | 574.00 |
| | 4 | 567.00 | 571.00 |
| | 5 | 564.00 | 568.00 |

Note:

All categories are established for classification of products. Products may not be available in all categories. Please contact your Avago representatives for further clarification/information.

Contrast Enhancement

For information on contrast enhancement, please see Application Note 1015.

Soldering/Cleaning

For information on soldering LEDs, please refer to Application Note 1027.

Electrical/Optical

For more information on electrical/optical characteristics, please see Application Note 1005.

For product information and a complete list of distributors, please go to our web site: www.avagotech.com

Avago, Avago Technologies, and the A logo are trademarks of Avago Technologies in the United States and other countries. Data subject to change. Copyright © 2005-2014 Avago Technologies. All rights reserved. Obsoletes 5989-2795EN AV02-2555EN - March 26, 2014

